

**namco**<sup>®</sup>



**SOUL CALIBUR III  
ARCADE EDITION  
OPERATION MANUAL**

The actual product may differ slightly from the illustration.

**⚠ DANGER**

- To ensure safe operation of product, be sure to read this Operation Manual before use.
- Keep this Operation Manual in a safe place for quick access whenever needed.

# INTRODUCTION

---

Thank you for purchasing the SOUL CALIBUR III ARCADE EDITION (hereafter referred as the "product").

This product is used together with the SYSTEM 256 PC Board Kit or SYSTEM 246 PC Board Kit.

To operate a game machine using this product, please install a DVD-ROM drive to the Game PC Board by following the directions in the separate document, "Procedure for changing the DVD-ROM drive."

## This operation manual describes:

- How to operate the product correctly and make full use of its features
- How to conduct the following procedures safely
  - Installation the product in a general-purpose game machine cabinet (hereafter referred to as a "cabinet") and connection of cables
  - Adjustment for operation
  - Operation
  - Inspection, cleaning, and troubleshooting
  - Removal, storage, and transportation
  - Disposal

## Inquiries concerning the product and repairs

For further information about the product and repairs, please contact your distributor.

You are hereby notified that this product may fall within the scope of national export control legislation. You shall at all times comply fully with the requirements of such legislation and of all other applicable laws of any jurisdiction in relation to this product.

**MAGICGATE** is a copyrighted anti-copying technology created by Sony Corp. This **MAGICGATE** mark does not necessarily imply compatibility with other products bearing the "MAGICGATE" trademark.

**MAGICGATE** is a trademark of Sony Corporation.

Le présent document vous informe que ce produit peut être soumis à la législation de contrôle des exportations nationales. Vous êtes tenu(e) en permanence de vous conformer entièrement aux exigences d'une telle législation ainsi que de toute autre juridiction en relation avec ce produit.

**MAGICGATE** est une technique de protection de copyright créée par Sony Corporation. **MAGICGATE** ne veut pas nécessairement dire qu'il y a une compatibilité avec d'autres produits portant la marque commerciale "MAGICGATE".

**MAGICGATE** est une marque commerciale de Sony Corporation.

The DVD-ROM supplied with the product must not be copied, modified, distributed, or used for purposes other than the operation of the product. The contents of the DVD-ROM are protected by copyright laws. Infringement of copyright laws may subject persons to criminal penalties.

Do not use the supplied DVD-ROM in any other product models or media formats. Doing so may result in equipment failure.

# 1. SAFETY PRECAUTIONS - Be sure to read these instructions to ensure safety -

## Instructions to the owner:

- If you entrust another party to perform installation, connection, adjustment, operation, inspection, cleaning, troubleshooting, removal, storage, transportation, and/or disposal of the product, instruct the concerned party to read and observe all the instructions and precautions in this operation manual regarding the particular action to be taken.
- When transferring the ownership of the product, be sure to provide this operation manual with the product.

## 1-1 Magnitudes of risk

On the labels attached to the product and in this operation manual, safety precautions and property damage are classified as shown below in accordance with the magnitude of the particular risk.

 **DANGER** : Failure to avoid the risk results in death or serious injury in most cases.

 **WARNING** : Failure to avoid the risk may result in death or serious injury.

 **CAUTION** : Failure to avoid the risk may result in minor injury or property damage.

Notes related to machine functions but not to safety are marked with the following label:

 **NOTICE** : Notes related to functions or protection of the product.

## 1-2 Target readers of this operation manual

This operation manual is written for arcade personnel. However, the sections marked "To be conducted by a technician only" in the table of contents and with the section titles are written for technicians. These tasks should be conducted only by a technician.

**Technician:** A person engaged in machine design, manufacture, inspection or maintenance for a manufacturer of amusement equipment, or a person who has technical knowledge related to electricity, electronics or mechanical engineering at a level equal to or higher than that of technical high school graduates, and who is engaged routinely in maintaining (repairing) amusement equipment.

## 1-3 Top-priority safety precautions

### 1-3-1 General safety precautions

#### WARNING

- Do not disassemble or modify the product. Also, do not perform any work that is not described in this operation manual. Failure to observe this caution can result in an electric shock or fire, and may disallow you from receiving repair services.
- This product is designed for use in Japan, and does not comply with specifications used overseas. Use of the product outside Japan can result in an electric shock or fire. Use the product only in Japan.
- Do not install, connect or operate the product outdoors. The product is designed for indoor use only. If the product is installed, connected or operated outdoors, an electric shock or fire may result.
- Use parts specified by NAMCO when parts must be replaced. Use of different parts can result in a fire or electric shock.  
To order parts, contact your distributor.
- To prevent an electric shock or earth leakage, do not perform work with wet hands.
- Before installing, connecting, inspecting, cleaning, troubleshooting, or removing the product, turn off the power switch on the cabinet, and unplug the power cord from the electrical outlet to prevent an electric shock.

### 1-3-2 Safety precautions for installation and connection

#### WARNING

When connecting to JAMMA Standard conforming cabinet (JAMMA (B) PC Board Kit (optional) is required for connection)

- The power supply connected to the JAMMA edge connector from the cabinet must comply with the following specifications.
  - +5V power supply: allowed voltage fluctuation of  $\pm 5\%$  and current of 7A or higher
  - +12V power supply: allowed voltage fluctuation of  $\pm 5\%$  and current of 2 A or higher

Use of non-conforming power supply can cause a fire.

When connecting to JAMMA VIDEO Standard (JVS) conforming cabinet

- The power supply to the cabinet connected to the AC power source must comply with the following specifications.
  - +5V power supply: allowed voltage fluctuation of  $\pm 5\%$  and current of 7A or higher
  - +12V power supply: allowed voltage fluctuation of  $\pm 5\%$  and current of 2 A or higher

Use of non-conforming power supply can cause a fire.

### 1-3-3 Cautions in operation

#### WARNING

- Should a problem occur, such as an abnormal odor or noise, turn off the power switch on the cabinet immediately to stop the machine operation. Then, unplug the power cord from the electrical outlet, and contact your distributor. Operating the machine with a problem left uncorrected may cause an electric shock or fire.
- Make sure that the product has been installed and connected according to the specified directions (refer to P. 11 "5. Installation and Connection (when using JAMMA Video Standard (JVS) cabinet) or P. 22 "5. Installation and Connection (when using JAMMA Standard cabinet)) in this operation manual before operating. Incorrect installation or connection can cause a fire, electric shock or equipment malfunction.

### 1-3-4 Cautions for disposal

#### WARNING

- Never throw the product into flames. Flames can cause the lithium battery contained in the product to explode and cause injury.
- When discarding the product, be sure to handle, transport and dispose of the product according to the law.
- When entrusting another party to handle, transport and disposed of the product, be sure to use a company specializing in the particular work to be assigned.

# CONTENTS

---

## INTRODUCTION

<b>1. SAFETY PRECAUTIONS - Be sure to read these instructions to ensure safety</b> .....	<b>1</b>
1-1 Magnitudes of risk .....	1
1-2 Target readers of this operation manual .....	1
1-3 Top-priority safety precautions .....	2
1-3-1 General precautions .....	2
1-3-2 Safety precautions for installation and connection .....	2
1-3-3 Cautions for operation .....	3
1-3-4 Cautions for disposal .....	3
<b>CONTENTS</b> .....	<b>4</b>
<b>2. SPECIFICATIONS</b> .....	<b>7</b>
<b>3. CHECKING THE PACKAGE CONTENTS</b> .....	<b>8</b>
<b>4. NAMES OF PARTS</b> .....	<b>9</b>
●SYSTEM 256 .....	9
●SYSTEM 246 Rack (B) Assy .....	9
●SYSTEM 246 Rack (C) Assy .....	10
<b>5. INSTALLATION AND CONNECTION - To be conducted by a technician only - (for JAMMA VIDEO Standard (JVS) conforming cabinet)</b> .....	<b>11</b>
5-1 Preparation for installation .....	11
5-2 Installation conditions .....	12
5-3 Connection to JAMMA VIDEO Standard (JVS) conforming cabinet .....	13
5-3-1 Installing in the cabinet .....	13
5-3-2 Connecting the control panel .....	15
5-3-3 Connecting the cable .....	16
5-4 Insertion of dongle .....	18
5-5 Insertion of DVD-ROM .....	19
5-6 Attachment of stickers .....	21
<b>6. INSTALLATION AND CONNECTION - To be conducted by a technician only - (for JAMMA Standard conforming cabinet)</b> .....	<b>22</b>
6-1 Preparation for installation .....	22
6-2 Installation conditions .....	23
6-3 Connection to JAMMA Standard conforming cabinet .....	24
6-3-1 Installing in the cabinet .....	24
6-3-2 Connecting the control panel .....	27

---

9-2-1 Mode change .....	67
<b>10. REMOVAL, STORAGE AND TRANSPORTATION .....</b>	<b>69</b>
10-1 Removal - To be conducted by a technician only - .....	69
10-2 Storage .....	69
10-3 Transportation .....	69
<b>11. DISCARDING THE PRODUCT .....</b>	<b>70</b>
<b>12. PARTS LIST .....</b>	<b>71</b>

6-3-3	Checking the extension harness .....	28
6-3-4	Connecting the control panel .....	29
6-3-5	Connecting the speaker .....	31
	● Monaural speaker system .....	31
	● Stereo speaker system .....	31
6-3-6	Connecting the connector .....	32
6-4	Insertion of dongle .....	34
6-5	Insertion of DVD-ROM .....	35
6-6	Attachment of stickers .....	37
<b>7.</b>	<b>ADJUSTMENT FOR OPERATION .....</b>	<b>38</b>
7-1	Adjustment .....	39
7-1-1	Option switches .....	39
	(1) Option switches .....	39
	(2) Speaker volume (knob) (for JAMMA Standard conforming cabinet only) .....	40
7-1-2	Selection of adjustment item .....	40
7-1-3	Exiting from test mode .....	42
7-2	Test mode .....	43
7-2-1	Display test (checking and adjusting screen display) .....	43
	(1) Color bar and color edit (checking and adjusting image contrast and color balance) .....	44
	(2) Convergence (checking and adjusting image size, display position, aspect ratio and distortion) .....	46
	(3) Interlace check (switching mode between interlace and non-interlace) .....	46
7-2-2	Input test (switch test) .....	49
7-2-3	Sound test .....	50
7-2-4	JVS status .....	52
7-2-5	Game options .....	53
7-2-6	Coin options .....	56
7-2-7	Bookkeeping .....	58
7-2-8	Clock setting .....	59
7-2-9	Data clear .....	60
<b>8.</b>	<b>MAINTENANCE .....</b>	<b>62</b>
8-1	Operating environment .....	63
8-2	Play instructions .....	63
	Manipulating the game character .....	63
	Description of game modes .....	63
<b>9.</b>	<b>INSPECTION, CLEANING AND TROUBLESHOOTING .....</b>	<b>64</b>
	- To be conducted by a technician only .....	64
9-1	Inspection and cleaning .....	64
9-2	Troubleshooting .....	65



## 2. SPECIFICATIONS

Item	Description
System board	SYSTEM 256 (246+ Mode), SYSTEM 246*2
Compatible standard	JAMMA Standard*3 (JAMMA (B) PC Board Kit (option) is required for connection) JAMMA VIDEO Standard (JVS)*4
Size	See the specifications of the PC board.
Weight	
Operating environment	
Input power	[When connected to JAMMA Standard connectors] +5V, ±5% (7 A min.) and +12V, ±5% (2 A min.) [When connected to JAMMA VIDEO Standard (JVS) connectors] +5V, ±5% (7 A min.) and +12V, ±5% (2 A min.)
Connectable cabinet	JAMMA Standard conforming cabinet (JAMMA (B) PC Board Kit (option) is required for connection) JAMMA VIDEO Standard (JVS) conforming cabinet
Monitor orientation and monitor signal	Monitor orientation: Landscape Horizontal synchronization frequency: 15.75 kHz (factory setting)/31.5 kHz, selectable*5 Scan fly-back line type: [When set to 15.75 kHz] Interlace (factory setting)/non-interlace, selectable*6 [When set to 31.5 kHz] Non-interlace (fixed) RGB output level: 0.7 Vp-p * When JAMMA(B) PC Board Kit (option) is installed: 3.0 Vp-p (factory setting)/0.7 Vp-p, selectable*7 Synchronization signal: Composite (factory setting)/separate, selectable*8 Vertical synchronization frequency: 60.0 Hz
Communication-linked setup	Communication-linked versus game setup possible with one PC board when two JAMMA VIDEO Standard (JVS) conforming cabinets are connected by a cable.
Control panel of connected cabinet	[Pair control panel (for two-person play with single cabinet)] • 8-direction lever ..... 1 x 2      • Button switch ..... 4 x 2 • Start switch ..... 1 x 2 [Single control panel (for communication-linked versus game setup with two cabinets connected with cable)] On each cabinet • 8-direction lever ..... 1      • Button switch ..... 4 • Start switch ..... 1
Method of installation in cabinet	In accordance with the operation manual of the cabinet

\*1 Regarding the change of mode, refer to page 67 or 68.

\*2 This product does not support some SYSTEM 246 system boards. For details, refer to "4. NAMES OF PARTS" on page 9.

\*3 JAMMA Standard (JS)  
Standard for edge connectors of video game boards established by Japan Amusement Machinery Manufacturers Association (JAMMA) in 1986.

\*4 JAMMA VIDEO Standard (JVS)  
Standard for connection between video game boards and peripheral devices established by Japan Amusement Machinery Manufacturers Association (JAMMA) in 1996.

\*5, \*7, \*8 Regarding the change of the horizontal synchronization frequency, RGB output level, and synchronization signal, refer to "7-1-1 Option switches" on page 39.

\*6 Regarding the change between non-interlace and interlace, refer to "7-2-1 (3) Interlace check" on page 43.













### 3. CHECKING THE PACKAGE CONTENTS

The game machine contains the following parts.



- Make sure that all the parts listed below are included in the product package.
- If there are any missing parts, contact your distributor.
- Keep the package box. The box is used to send the product for a repair.

#### • Accessory list

No.	Name	Specification		Qty
1	DVD-ROM			1
2	Operation manual	SOUL CALIBUR III ARCADE EDITION Operation Manual		1
3	Title board			2
4	Explanation board E	Operation instructions		2
5	Technique explanation sticker (A) E	Game character fighting technique chart (Part I)		2
6	Technique explanation sticker (B) E	Game character fighting technique chart (Part II)		2
7	Dongle	Attached with a bar code label		1
8	Button sticker	1 set each for P1 and P2		1
9	SOUL CALIBUR III S 246 B explanation board E			1
10	Battery			1
11	Procedure for changing the battery			1
12	Procedure for changing the DVD-ROM drive			1

## 4. NAMES OF PARTS

### ● SYSTEM 256



- Be sure to change the mode of the SYSTEM 256 to "246+ Mode." The product will not operate properly if the mode is set to "256 Mode." Regarding the method of changing the mode, see page 67.

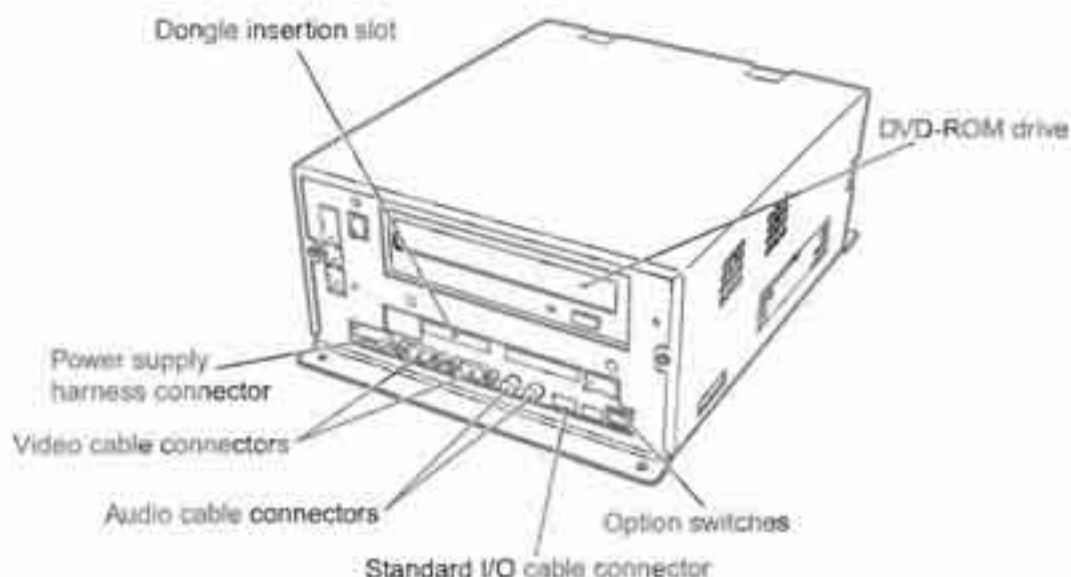

### ● SYSTEM 246 Rack (B) Assy

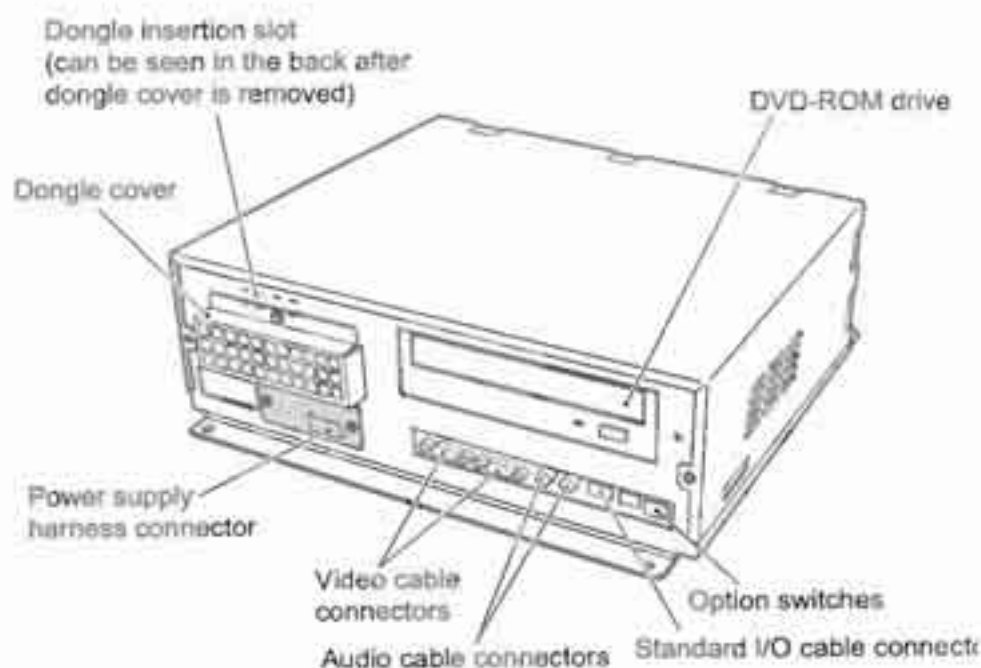

### ●SYSTEM 246 Rack (C) Assy

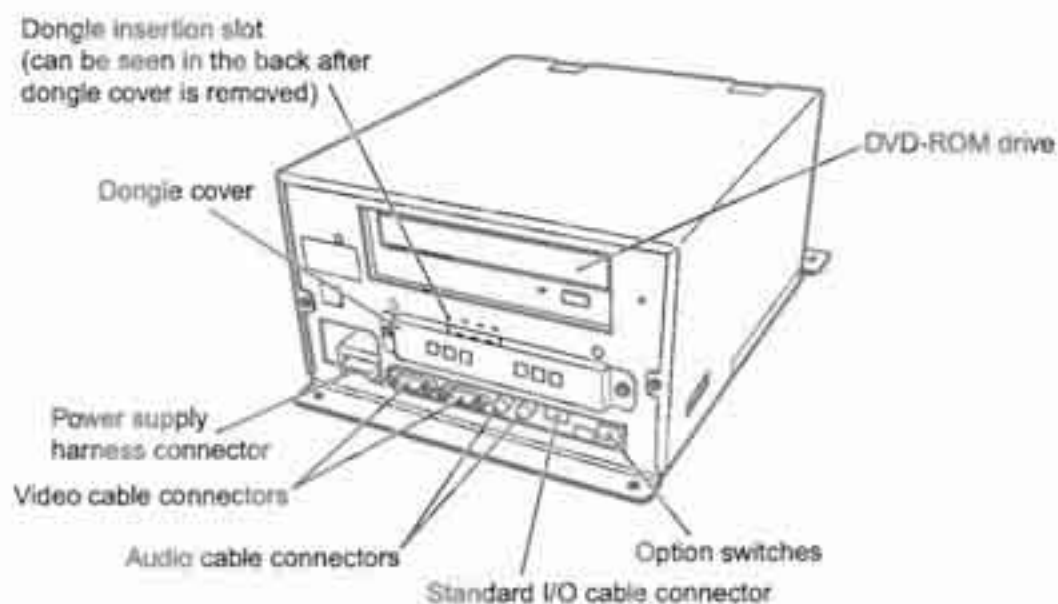

- Do not use a Game PC Board other than the three types described in this manual. Use of this product with the Game PC Board of another game can result in operation malfunctions or equipment damage.

## 5. INSTALLATION AND CONNECTION

(when using JAMMA Video Standard (JVS) cabinet) - To be conducted by a technician only -

### WARNING

- Before installing and connecting the product, turn off the power switch on the cabinet and unplug the power cord from the electrical outlet to prevent an electric shock.
- Do not install or connect the product outdoors. The product is designed for indoor use. If the product is installed or connected outdoors, an electric shock or fire may result.

### NOTICE

- Make sure that the following work is conducted by a technician.
- Make sure that the person performing the installation or connection is not charged with static electricity. Static electricity can cause a product malfunction or damage.
- Do not perform a conductivity test using a tester. The internal voltage in a tester can damage the ICs on the PC board and render the PC board useless.

The product can be used with a JAMMA VIDEO Standard (JVS) cabinet or JAMMA Standard cabinet. However, the connection method varies depending on the type of the cabinet used. When installing the product in a JAMMA Standard cabinet, refer to "6. INSTALLATION AND CONNECTION (when using JAMMA Standard cabinet)" on page 22.

- Check the cabinet specifications for compatibility with this product by referring to "2. SPECIFICATIONS" on page 7.
- When the JAMMA (B) PC Board Kit (option) is installed, the product cannot be connected to a JAMMA VIDEO Standard (JVS) conforming cabinet.

### 5-1 Preparation for installation

Prepare the following items for the installation of the product.

Required item	Description
Insulation tape	Used to insulate the ends of unused harnesses and connectors.
Operation manual of the cabinet used	To check the handling directions for the cabinet.
Tools provided with the cabinet	Used for the installation of parts.
Phillips screwdriver	Used for the installation of parts.

## 5-2 Installation conditions

When installing the Game PC board, make sure that the mounting angle is within  $\pm 10$  degrees from the horizontal or vertical direction. See the following diagrams for details.

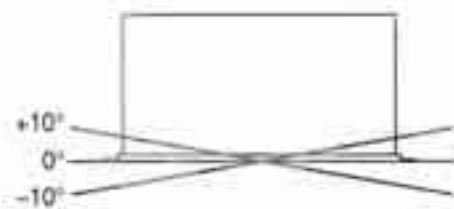
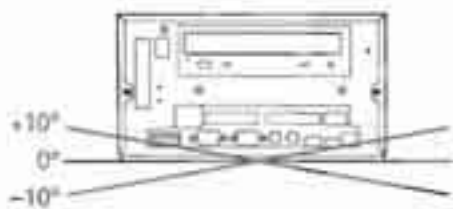

Horizontal installation

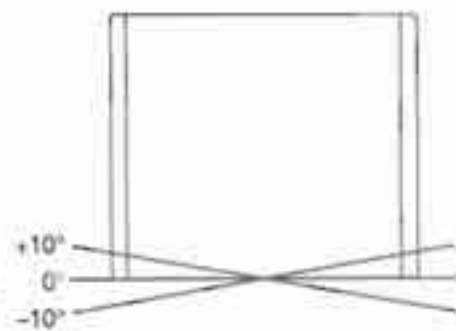
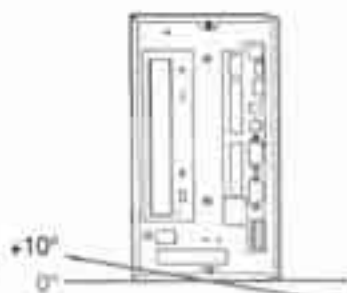
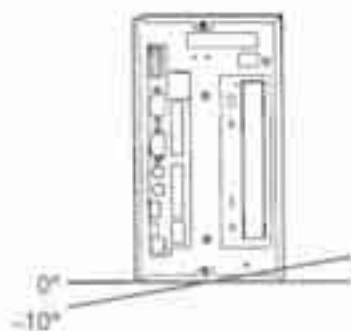

Vertical installation



- Be sure to install the Game PC board at a position where the air intake and discharge vents on the side of the Game PC board are not blocked. If the vents are blocked, a malfunction or damage can occur.

## 5-3 Connection to JAMMA VIDEO Standard (JVS) conforming cabinet

The following describes the method of connecting the Game PC Board for use in a JAMMA VIDEO Standard (JVS) conforming cabinet.

### 5-3-1 Installing in the cabinet - To be conducted by a technician only -

#### WARNING

- Before conducting the task described below, turn off the power switch on the cabinet and unplug the power cord from the electrical outlet to protect the service staff and other people from electric shock, accidents and injury and to prevent damage to electrical circuits.

- 1 Turn off the power switch on the cabinet, and unplug the power cord from the electrical outlet.
- 2 Open the cover of the PC board compartment and take out the PC board mounting plate in accordance with the directions for PC board installation in the operation manual of the cabinet used.

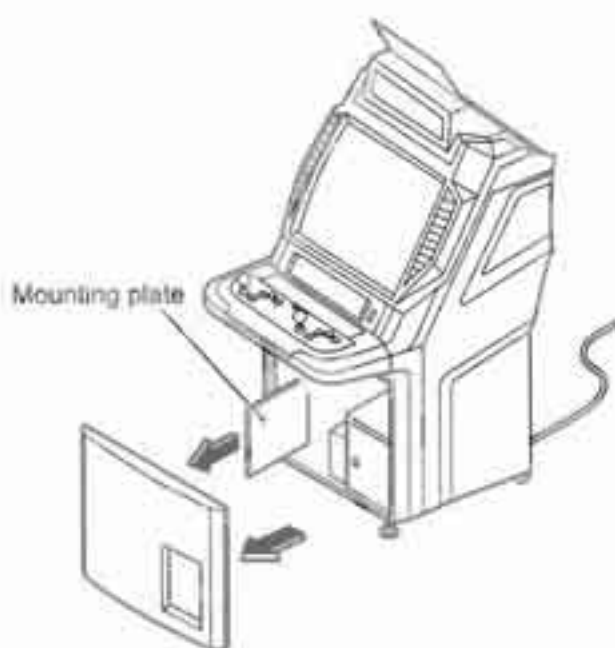

## 5. INSTALLATION AND CONNECTION (when using JAMMA Video Standard (JVS) cabinet)

- 3 If another PC board is connected to the mounting plate, dismount the PC board in accordance with the procedure described in the operation manual of the cabinet.
- 4 Using four supplied Phillips tapping bind A ( $\phi 5 \times 12$ ) screws, install the Game PC board at a location on the mounting plate where the installed PC board will not hinder the installation and removal of the mounting plate.

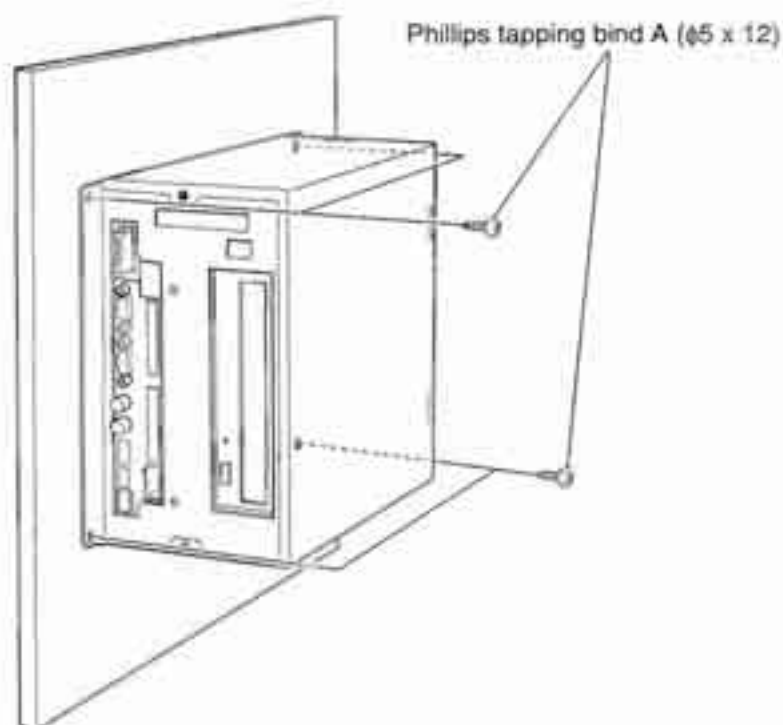



### 5-3-2 Connecting the control panel

Connect the product to the control panel (see the diagram below) described in "2. SPECIFICATIONS" (page 7).

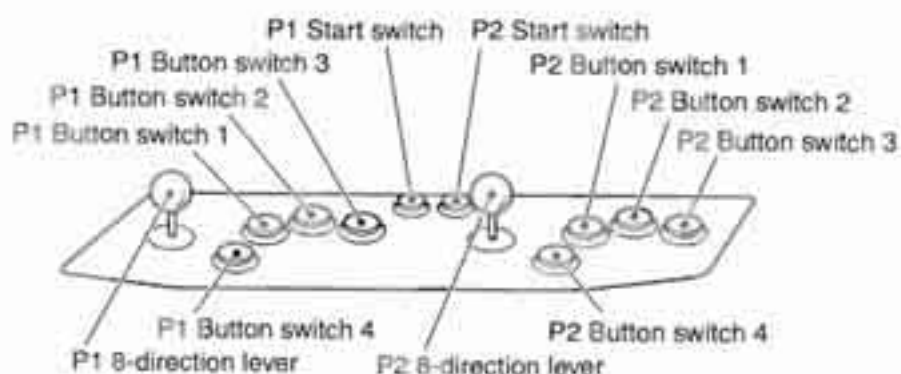

Pair control panel (for two-person play with single cabinet)

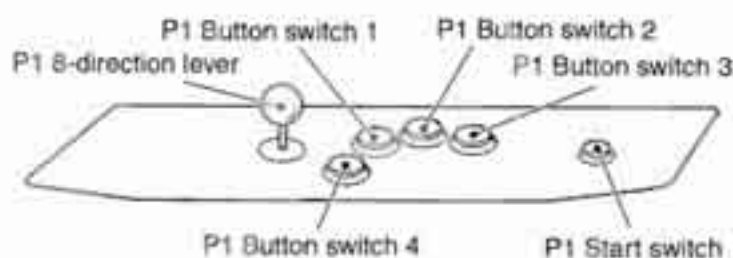

Single control panel (for communication-linked versus game setup with two cabinets connected with cable)

(Note) The above diagram shows the control panel of a cabinet in which the Game PC Board is installed. On a cabinet not installed with the Game PC Board, the lever and buttons are for P2.

The names of the levers and switches in the above diagrams correspond with the following general names of the control panel connection terminals (provided on the cabinet) of a JAMMA VIDEO Standard (JVS) conforming cabinet.

P1 side		P2 side	
Name of lever/switch in above diagram	Name of control cabinet panel connection terminal of JVS conforming	Name of lever/switch in above diagram	Name of control cabinet panel connection terminal of JVS conforming
P1 Start switch	1P_START	P2 Start switch	2P_START
P1 8-direction lever (UP)	1P_UP	P2 8-direction lever (UP)	2P_UP
P1 8-direction lever (DOWN)	1P_DOWN	P2 8-direction lever (DOWN)	2P_DOWN
P1 8-direction lever (LEFT)	1P_LEFT	P2 8-direction lever (LEFT)	2P_LEFT
P1 8-direction lever (RIGHT)	1P_RIGHT	P2 8-direction lever (RIGHT)	2P_RIGHT
P1 Button switch 1	1P_PUSH1	P2 Button switch 1	2P_PUSH1
P1 Button switch 2	1P_PUSH2	P2 Button switch 2	2P_PUSH2
P1 Button switch 3	1P_PUSH3	P2 Button switch 3	2P_PUSH3
P1 Button switch 4	1P_PUSH4	P2 Button switch 4	2P_PUSH4



- 2** Connect the cables on the cabinet side to their respective connectors of the Game PC Board, as shown below.

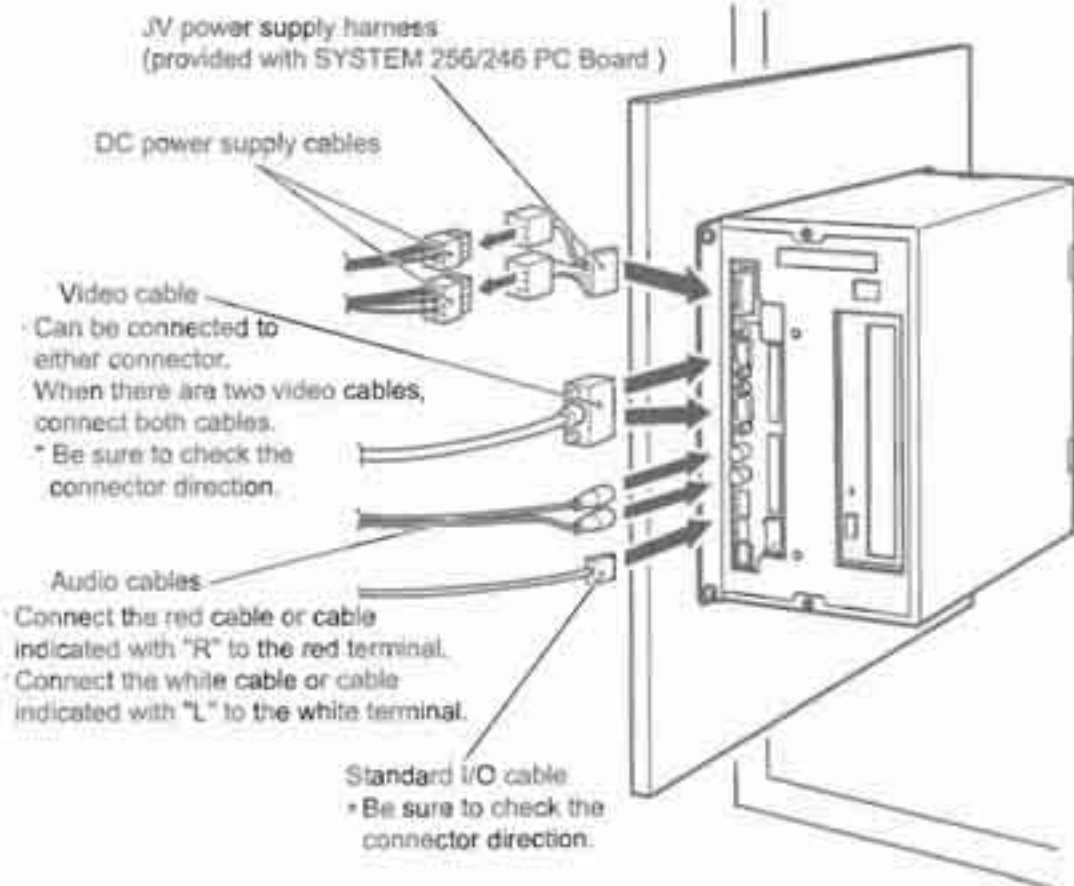

- 3** Cover unused connectors on the cabinet side with insulation tape to prevent short-circuits.

- 4** Install the Game PC Board in the cabinet.



- Make sure the mounting plate is securely installed to the cabinet. If it is loose, equipment malfunctions can result due to vibrations.
- After installing the Game PC Board in the cabinet, check to make sure that the Game PC Board is not in contact with harnesses or cables. If the Game PC Board is in contact with a harness or cable, malfunctions can result during operation.



## 5-4 Insertion of dongle



- The provided dongle is designed exclusively for this product. Never use this dongle in another product. Also, do not use the dongle of another game in this product. Failure to observe this instruction can result in equipment malfunctions.
- Insert the dongle firmly in the specified slot. Incorrect insertion can cause a malfunction.

- 1** Turn off the power switch on the cabinet, and unplug the power cord from the electrical outlet.
- 2** Insert the dongle into the dongle insertion slot (left slot), making sure that the side with the bar code label faces upward. Push the dongle until the dongle engages with the connector inside the slot.

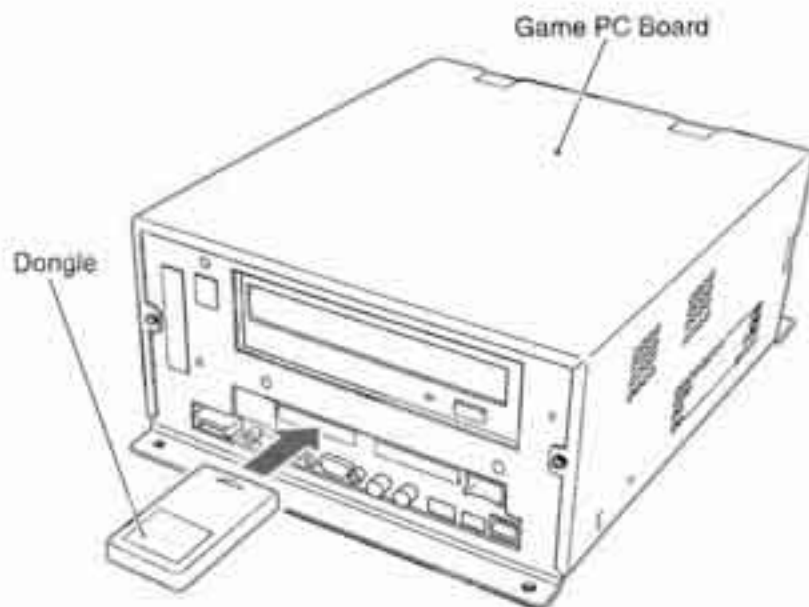

## 5-5 Insertion of DVD-ROM

### WARNING

- The DVD-ROM must be inserted with the power switch turned on. To prevent electric shock, accident and injury, do not touch sections other than those specified in the work procedures.

#### NOTICE

- The provided DVD-ROM is designed exclusively for this product. Never use this DVD-ROM in another product. Also, do not insert any other DVD-ROM in the DVD-ROM drive. Failure to observe this instruction can result in equipment malfunctions.
- Be careful of the tray as it automatically closes after about ten seconds.

- 1** Turn on the power switch on the cabinet.
- 2** Press the Eject button of the DVD-ROM drive to eject the tray.

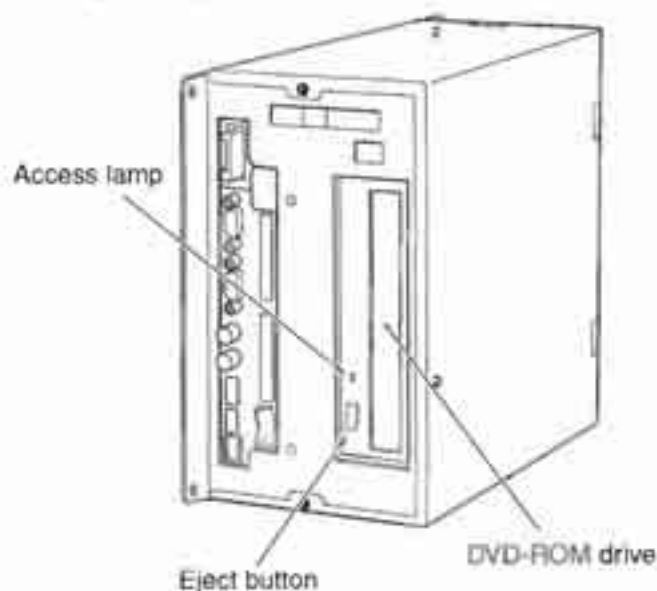

- 3** With the label side (printed surface) of the DVD-ROM facing away from the tray, set the DVD-ROM on the tray.

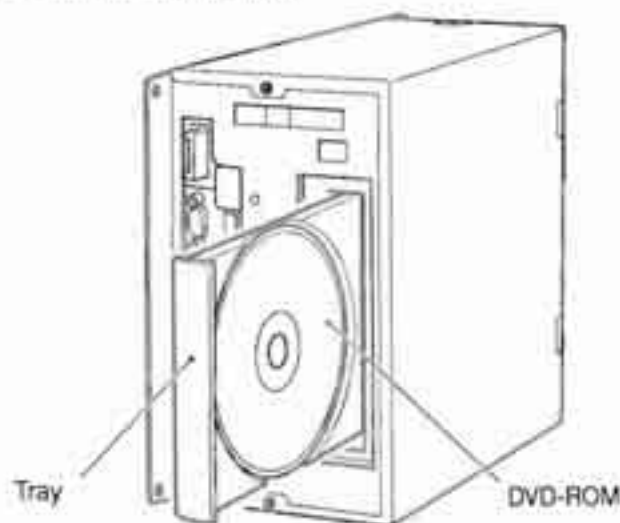

## 5. INSTALLATION AND CONNECTION (when using JAMMA Video Standard (JVS) cabinet)

---

- 4** Press the Eject button of the DVD-ROM drive to retract the tray into the drive.
- 5** When the Access lamp on the DVD-ROM drive stops flashing, turn off the power switch on the cabinet.
- 6** According to the directions in the operation manual of the cabinet, close the Game PC Board compartment.



## 5-6 Attachment of stickers

Affix the supplied stickers on the cabinet.

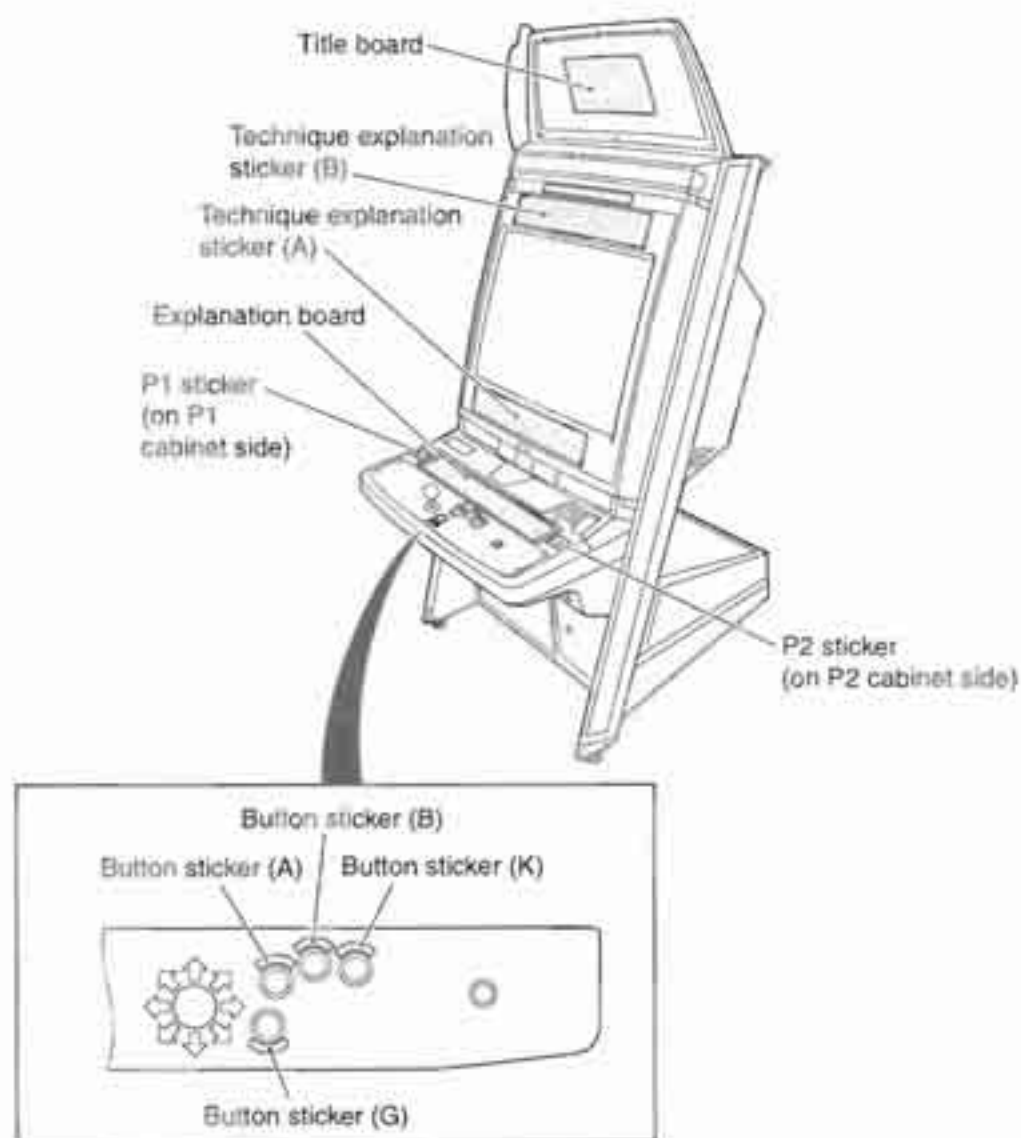

## 6. INSTALLATION AND CONNECTION

(when using JAMMA Standard conforming cabinet) - To be conducted by a technician only -

### WARNING

- Before installing and connecting the product, turn off the power switch on the cabinet and unplug the power cord from the electrical outlet to prevent an electric shock.
- Do not install or connect the product outdoors. The product is designed for indoor use. Installation or connection of the product conducted outdoors can cause an electric shock or fire.

#### NOTICE

- The following work must be conducted by a technician.
- Make sure that the person conducting the installation or connection is not charged with static electricity. Static electricity can cause malfunctions or damage to the product
- Do not perform a continuity test using a tester. Internal voltage of a tester can damage the ICs on the Game PC Board and render the PC board useless.

The product can be used with a JAMMA VIDEO Standard (JVS) or JAMMA Standard conforming cabinet. However, the connection method varies depending on the cabinet type. To install the product in a JAMMA VIDEO Standard (JVS) conforming cabinet, refer to "5. INSTALLATION AND CONNECTION (for JAMMA VIDEO Standard (JVS) conforming cabinet)" on page 11.

- Check the cabinet specifications for compatibility with this product by referring to "2. SPECIFICATIONS" on page 7.  
Installation of the product in a JAMMA Standard conforming cabinet requires the JAMMA (B) PC Board Kit (option).
- When the JAMMA (B) PC Board Kit (option) is installed, the product cannot be connected to a JAMMA VIDEO Standard (JVS) conforming cabinet.

### 6-1 Preparation for installation

Prepare the following items for the installation of the product.

Required item	Description
Insulation tape	Used to insulate the ends of unused harnesses and connectors.
Operation manual of the cabinet used	To check the handling directions for the cabinet.
Tools provided with the cabinet	Used for the installation of parts.
Phillips screwdriver	Used for the installation of parts.
Soldering iron, or crimping tool and crimp-style terminals	Used to connect wires to microswitches. May not be needed in some cases.
Heat-shrink insulation tube and dryer for heating	Used to insulate wire connections. May not be needed in some cases.



## 6-2 Installation conditions

When installing the Game PC board, make sure that the mounting angle is within  $\pm 10$  degrees from the horizontal or vertical direction. See the following diagrams for details.

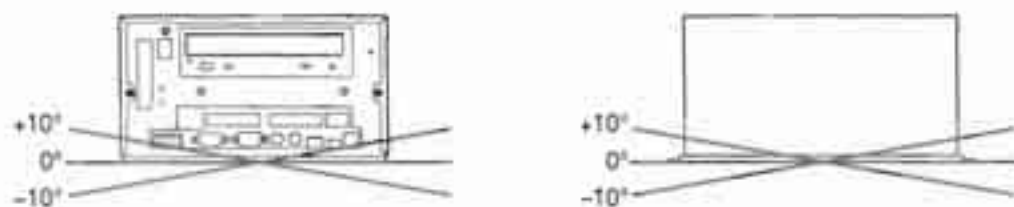

Horizontal installation



Vertical installation



- Be sure to install the Game PC board at a position where the air intake and discharge vents on the side of the Game PC board are not blocked. If the vents are blocked, a malfunction or damage can occur.

## 6-3 Connection to JAMMA Standard conforming cabinet

### 6-3-1 Installing in the cabinet - To be conducted by a technician only -

#### WARNING

- Before conducting the task described below, turn off the power switch on the cabinet and unplug the power cord from the electrical outlet to protect the service staff and other people from electric shock, accidents and injury and to prevent damage to electrical circuits.

- 1 Turn off the power switch on the cabinet, and unplug the power cord from the electrical outlet.
- 2 Open the cover of the PC board compartment and take out the PC board mounting plate in accordance with the directions for PC board installation in the operation manual of the cabinet used.

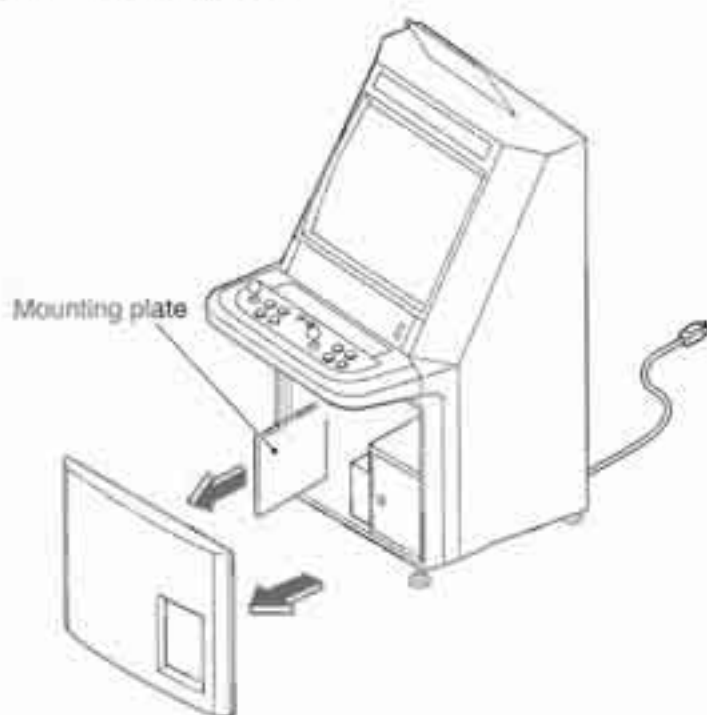

- 3 If another PC board is connected to the mounting plate, dismantle the PC board in accordance with the procedure described in the operation manual of the cabinet.

- 4 Mount locking legs on the SYSTEM 246 JAMMA(B) PC board (option).

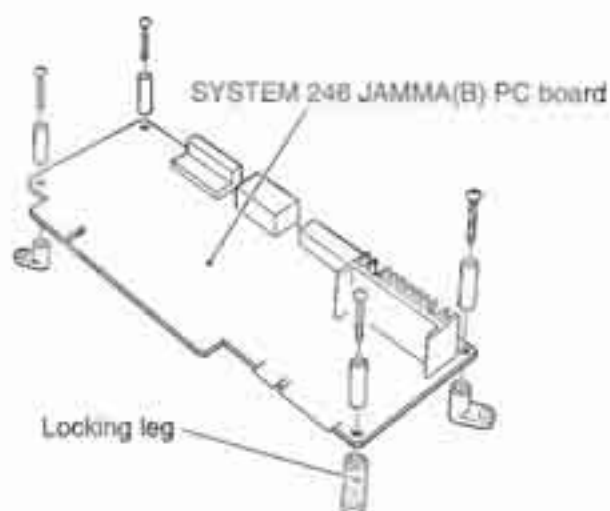

- When installing the SYSTEM 246 JAMMA(B) PC board, be sure to use the parts supplied with the SYSTEM 246 JAMMA(B) PC board. Using parts of a different product can cause a malfunction and damage.

- 5 Connect the four harnesses between the Game PC board and the System 246 JAMMA(B) PC board. For the video cable harness, the connector with the core should be connected to the Game PC board.

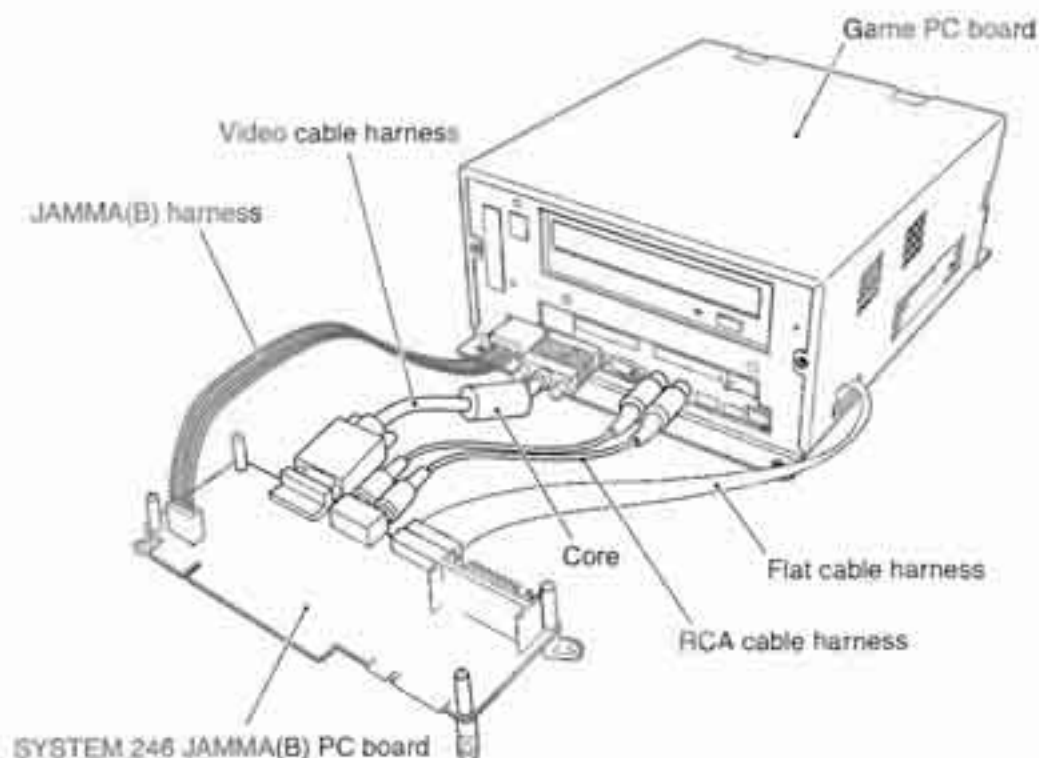

- 6** Using eight supplied Phillips tapping bind A ( $\phi 5 \times 12$ ) screws, install the Game PC board and SYSTEM 246 JAMMA(B) PC board at locations on the mounting plate where they will not hinder the installation and removal of the mounting plate.

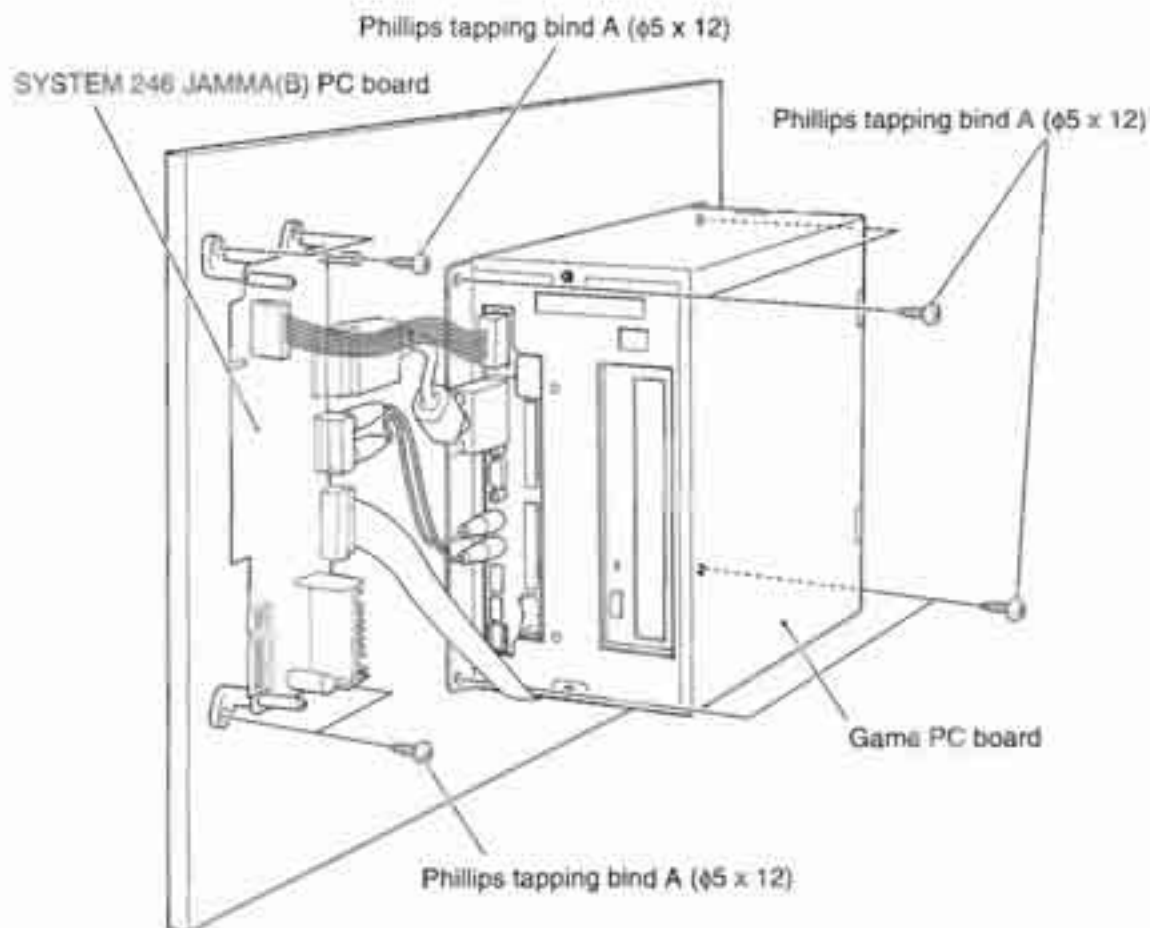

- If the cabinet is dirty, clean it with a vacuum cleaner.
- When installing the Game PC board and SYSTEM 246 JAMMA(B) PC board, be sure to use the screws provided with the product and SYSTEM 246 JAMMA(B) PC Board Kit (option).
- Be sure to install the Game PC board at a position where the air intake and discharge vents on the side of the Game PC board are not blocked. If the vents are blocked, a malfunction or damage can occur.

### 6-3-2 Connecting the control panel

To connect the product to a JAMMA Standard conforming cabinet, use the JAMMA edge connector supplied with the cabinet.

- 1** Check to see if the terminal numbers on the JAMMA edge connector of the cabinet corresponds with the JAMMA edge connector specifications shown in the table below. If not, use a soldering iron or appropriate crimp-style terminals to connect wires as indicated in the table.



- Cover connections with heat-shrink insulation tubes to prevent short-circuits.
- Do not connect wires to the terminals with no indication in the table. Connection of a wire to those terminals can cause malfunctions of the Game PC Board.

JAMMA edge connector (56-pin, 3.96-mm pitch)

Soldered surface	Terminal No.		Component surface
GND	A	1	GND
GND	B	2	GND
+5V	C	3	+5V
+5V	D	4	+5V
	E	5	
+12V	F	6	+12V
Insertion error preventive key	H	7	Insertion error preventive key
Coin counter 2	J	8	Coin counter 1
	K	9	
Speaker (-)*1	L	10	Speaker (+)*1
Audio (GND)	M	11	Audio (+)
Video (GREEN)	N	12	Video (RED)
Video (SYNC)	P	13	Video (BLUE)
Service switch	R	14	Video (GND)
	S	15	Test switch
Coin switch 2	T	16	Coin switch 1
P2 Start switch	U	17	P1 Start switch
P2 Lever (UP)	V	18	P1 Lever (UP)
P2 Lever (DOWN)	W	19	P1 Lever (DOWN)
P2 Lever (LEFT)	X	20	P1 Lever (LEFT)
P2 Lever (RIGHT)	Y	21	P1 Lever (RIGHT)
P2 Button switch 1 (A)	Z	22	P1 Button switch 1 (A)
P2 Button switch 2 (B)	a	23	P1 Button switch 2 (B)
P2 Button switch 3 (K)	b	24	P1 Button switch 3 (K)
P2 Button switch 4 (G)*2	c	25	P1 Button switch 4 (G)*2
P2 Button switch 5 (K)*2*3	d	26	P1 Button switch 5 (K)*2*3
GND	e	27	GND
GND	f	28	GND

\*1: Monaural output also possible (See page 31).

\*2: Extension switch can also be used for connection. (See page 28)

\*3: The Button switch 5 can also be used, in place of the Button switch 3, as a Kick button.

- 2 Check the voltage of power supply from the cabinet to the JAMMA edge connector and the voltage of power supply to the coin counter in the cabinet.

## ⚠ WARNING

- The power supply from the cabinet to the JAMMA edge connector must comply with the following specifications.
    - +5V power supply: allowed voltage fluctuation of  $\pm 5\%$  and current of 7A or higher
    - +12V power supply: allowed voltage fluctuation of  $\pm 5\%$  and current of 2 A or higher
- Use of non-conforming power supply can cause a fire.



- If the voltage is too low, the LED on the JAMMA(B) PC Board flashes. When the LED flashes, check the power supply voltage.  
Use +12V or +5V power supply for the coin counter in the cabinet. Use of higher voltage can cause the Game PC Board to malfunction.

### 6-3-3 Checking the extension harness

When connecting the product to a JAMMA Standard conforming cabinet, use the extension switch harness and extension stereo harness supplied in the JAMMA(B) PC Board Kit.

Check to make sure that the terminal numbers on the extension switch harness and extension stereo harness correspond with those in the table below.

- If the JAMMA edge connector provided in the cabinet is connected to the P1 Button switch 4 and P2 Button switch 4 as shown in the table on the previous page (page 27), the extension switch harness is not used.



- Do not connect wires to the terminals with no indication in the table. Connection of a wire to those terminals can cause malfunctions of the Game PC Board.

Extension switch harness (EI10P)

Terminal No.	Signal name (wire color)
1	GND (BLACK)
2	
3	P2 Button switch 5 (white/orange)*1
4	P2 Button switch 4 (white/red)
5	
6	
7	P1 Button switch 5 (orange)*1
8	P1 Button switch 4 (red)
9	
10	GND (BLACK)

\*1: The Button switch 5 can also be used, in place of the Button switch 3, as a Kick button

Extension stereo harness (EI4P)

Terminal No.	Signal name (wire color)
1	
2	
3	Speaker R (+) (orange)
4	Speaker R (-) (yellow)

### 6-3-4 Connecting the control panel

The product is designed to connect to the control panel (see the diagram below) described in "2. SPECIFICATIONS" (page 7).

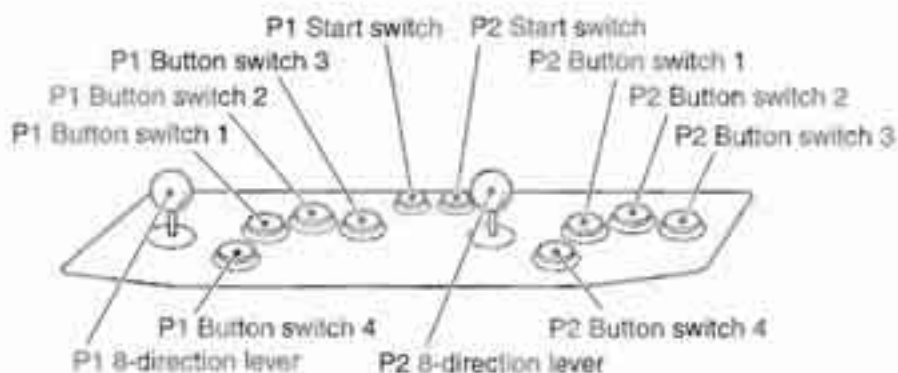

- 1** Turn off the power switch on the cabinet, and unplug the power cord from the electrical outlet.
- 2** By following the directions described in the section on control panel in the operation manual of the cabinet, remove the control panel.

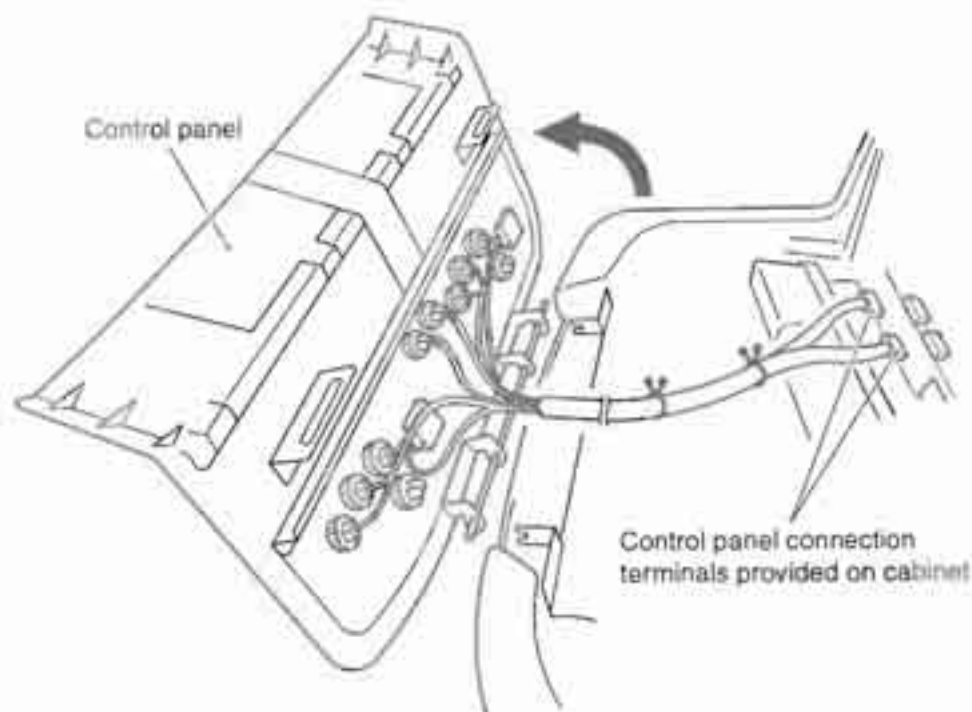

- 3** If the control panel is different from the one shown above, replace the control panel by following the directions in the operation manual of the cabinet, or add/remove button switches as necessary. When button switches are removed, be sure to cover the holes with caps.

- 4** If the JAMMA edge connector provided in the cabinet is not connected to the P1 Button switch 4 and P2 Button switch 4, connect the wires of the extension switch harness shown in the table below to the terminals of the P1 Button switch 4 and P2 Button switch 4 by using a soldering iron or crimp-style terminals.

Extension switch harness (EI10P)

Terminal No.	Signal name (wire color)
1	GND (BLACK)
4	P1 Button switch 4 (WHITE/RED)
8	P2 Button switch 4 (RED)
10	GND (BLACK)

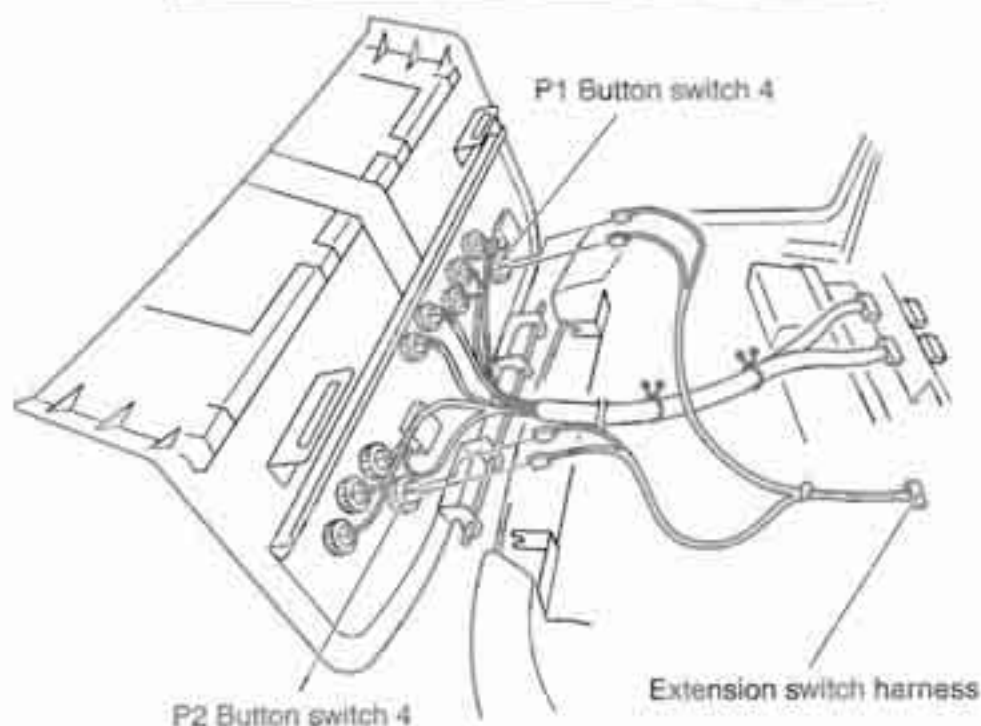

## ⚠ WARNING

- Be sure to use the extension switch harness provided in the JAMMA(B) PC Board Kit (option). Use of a different harness can cause a fire or electric shock.

### NOTICE

- Cover connections with heat-shrink insulation tubes to prevent short-circuits.
- If the button switches have three terminals each, connect the input wires (wires from terminal nos. 4 and 8) of the extension switch harness to the N.O. terminals of the button switches, and the GND wires (wires from terminals 1 and 10) to the COM terminals of the button switches. If the button switches have two terminals each, wires can be connected to either terminal.

- 5** Install the control panel to the cabinet.



### 6-3-5 Connecting the speaker

Connect the product to the speaker in the cabinet for sound reproduction.  
First, check if the cabinet has a monaural speaker or stereo speaker system.

#### ● Monaural speaker system

- 1 Turn off the power switch on the cabinet, and unplug the power cord from the electrical outlet.
- 2 After installing and connecting the Game PC Board, switch the setting to MONAURAL in the test mode (see "7-2-3 Sound test" on page 50).

\* The product is set to STEREO at the factory. If the product set to the stereo mode is connected to a cabinet with a monaural speaker system, only the left-channel sound will be reproduced.

#### ● Stereo speaker system

- 1 Turn off the power switch on the cabinet, and unplug the power cord from the electrical outlet.
- 2 Connect the wires from terminals 3 and 4 of the extension stereo harness to the right (R) speaker according to the table below by using a soldering iron or appropriate crimp-style terminals.

### WARNING

- Be sure to use the extension stereo harness provided in the JAMMA(B) PC Board Kit (option). Use of a different harness can cause a fire or electric shock.

Extension stereo harness (EI4P)

Terminal No.	Signal name (wire color)
3	Speaker R (+) (ORANGE)
4	Speaker R (-) (YELLOW)

### 6-3-6 Connecting the connector

- 1 Turn off the power switch on the cabinet, and unplug the power cord from the electrical outlet.
- 2 Connect the JAMMA edge connector provided in the cabinet, extension switch harness and extension stereo harness. When connecting the JAMMA edge connector, be sure to align the insertion error preventive key on the JAMMA edge connector with the notch on the connector of the Game PC Board, as shown below.



- Do not connect the JAMMA edge connector in reversed or misaligned position; otherwise, malfunctions can occur in the cabinet or Game PC Board.

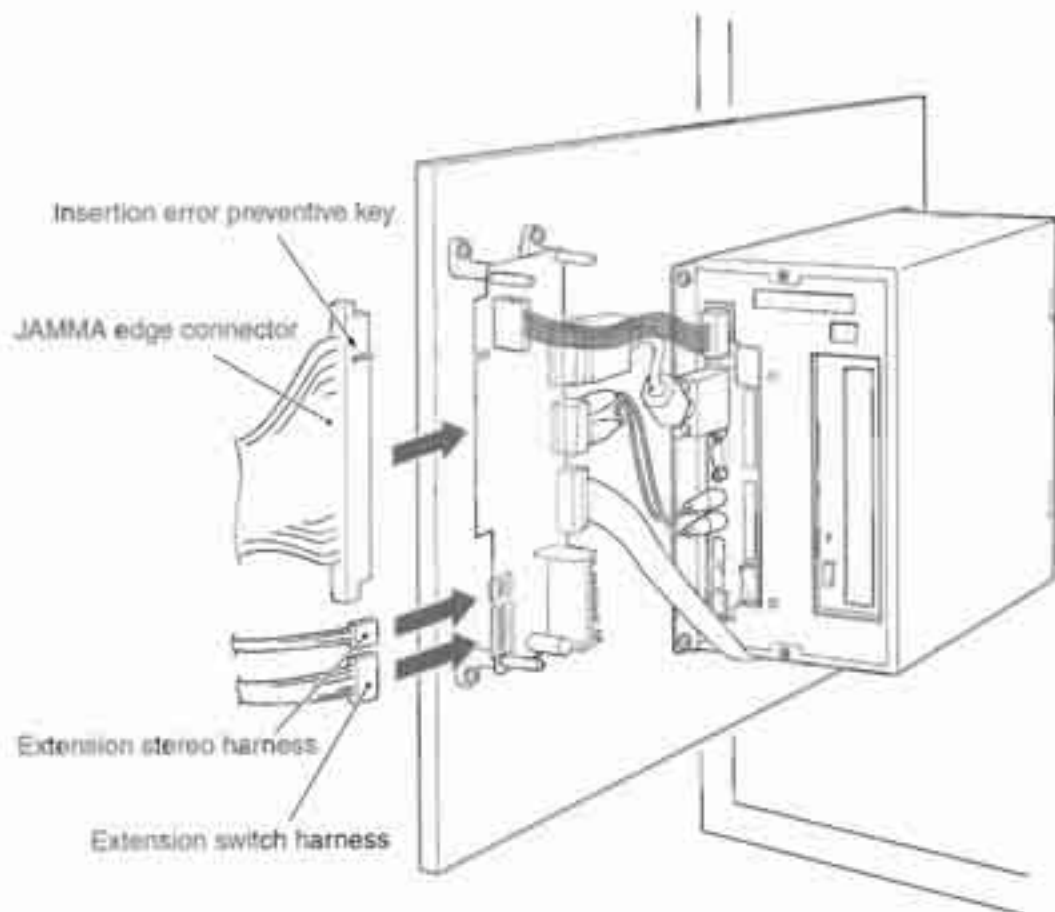

- 3 Install the PC board attached to the mounting plate in the cabinet.



- Be sure to install the mounting plate securely to the cabinet. If it is loose, malfunctions can result due to vibrations.
- After installing the Game PC Board in the cabinet, check to make sure that the Game PC Board is not in contact with harnesses or cables. If the Game PC Board is in contact with a harness or cable, malfunctions can result during operation.



## 6-4 Insertion of dongle



- The provided dongle is designed exclusively for this product. Never use this dongle in another product. Also, do not use the dongle of another game in this product. Failure to observe this instruction can result in equipment malfunctions.
- Insert the dongle firmly in the specified slot. Incorrect insertion can cause a malfunction.

- 1** Turn off the power switch on the cabinet, and unplug the power cord from the electrical outlet.
- 2** Insert the dongle into the dongle insertion slot (left slot), making sure that the side with the bar code label faces upward. Push the dongle until the dongle engages with the connector inside the slot.

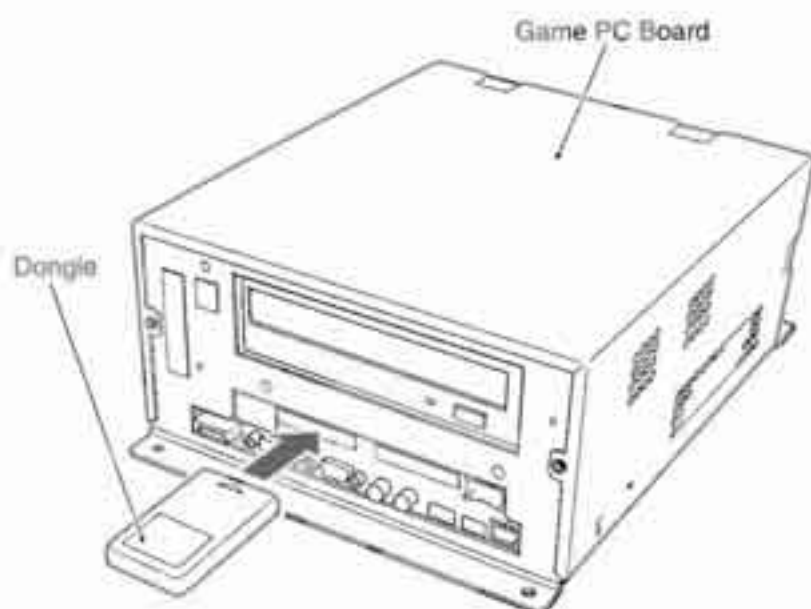

## 6-5 Insertion of DVD-ROM

### WARNING

- The DVD-ROM must be inserted with the power switch turned on. To prevent electric shock, accident and injury, do not touch sections other than those specified in the work procedures.

#### NOTICE

- The provided DVD-ROM is designed exclusively for this product. Never use this DVD-ROM in another product. Also, do not insert any other DVD-ROM in the DVD-ROM drive. Failure to observe this instruction can result in equipment malfunctions.
- Be careful of the tray as it automatically closes after about ten seconds.

- 1** Turn on the power switch on the cabinet.
- 2** Press the Eject button of the DVD-ROM drive to eject the tray.

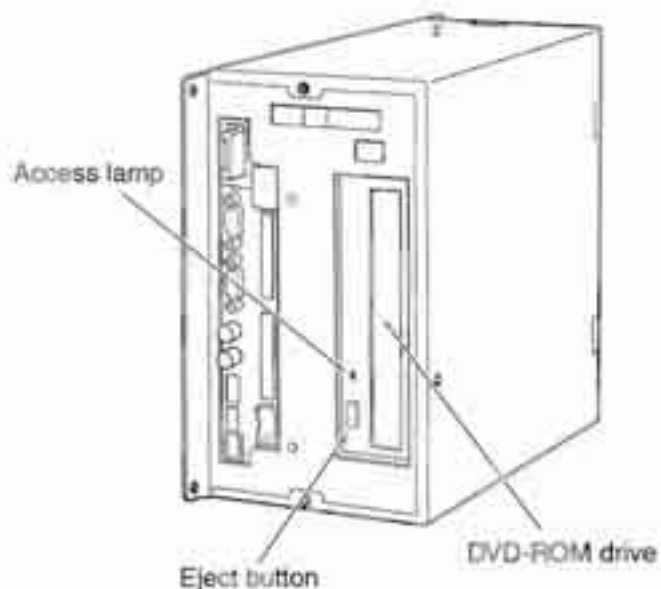

- 3** With the label side (printed surface) of the DVD-ROM facing away from the tray, set the DVD-ROM on the tray.



- 4** Press the Eject button of the DVD-ROM drive to retract the tray into the drive.
- 5** When the Access lamp on the DVD-ROM drive stops flashing, turn off the power switch on the cabinet.
- 6** According to the directions in the operation manual of the cabinet, close the Game PC Board compartment.



## 6-6 Attachment of stickers

Affix the supplied stickers on the cabinet.

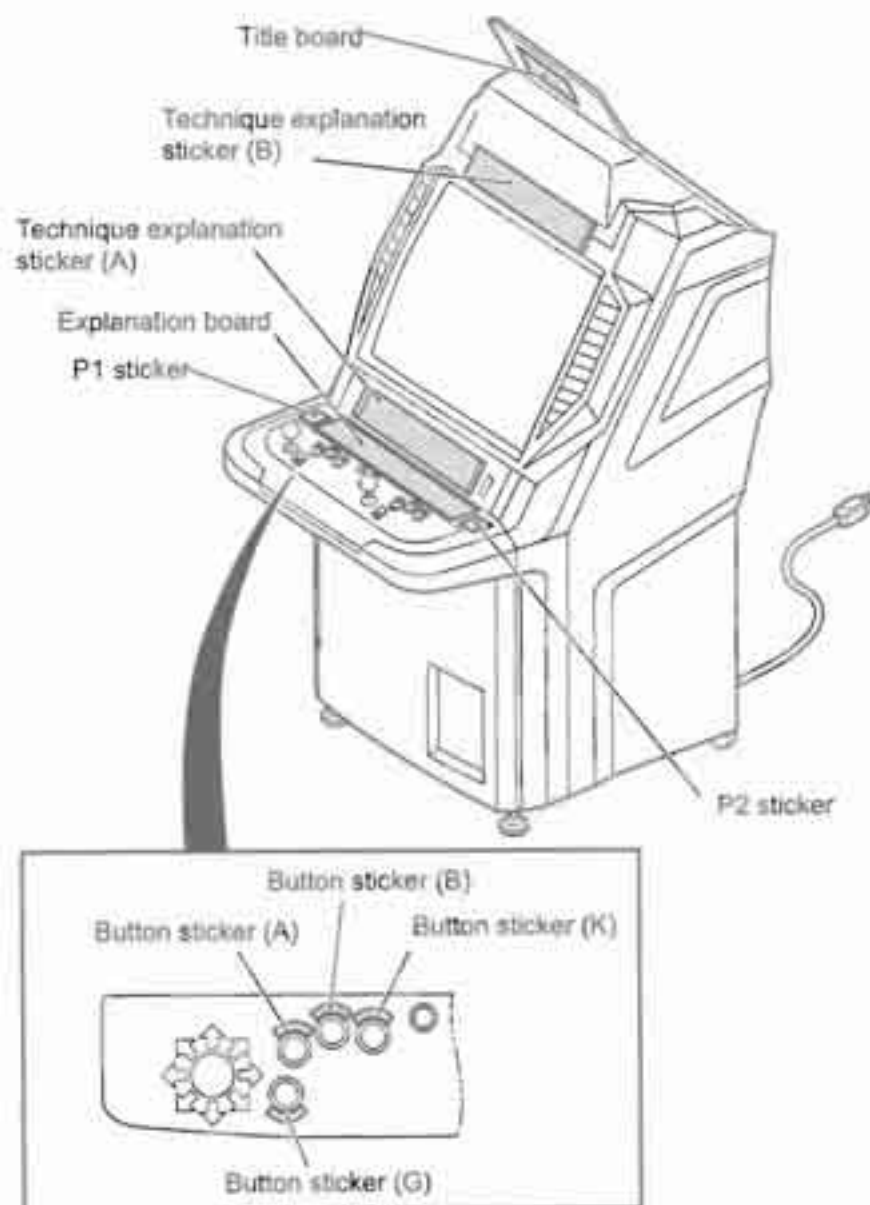

## 7. ADJUSTMENT FOR OPERATION

Before operating the game machine installed with the product, adjustments must be made according to the type of the cabinet used.

The following shows the adjustment items.

Adjustment item	Section and page
Confirmation and adjustment of screen display	7-2-1 Display test (page 43)
Testing of switches on control panel, etc.	7-2-2 Input test (page 49)
Testing of sound output and setting of speaker	7-2-3 Sound test (page 50)
Display of status of JAMMA VIDEO Standard (JVS) conforming cabinet	7-2-4 JVS status (page 52)
Settings for game	7-2-5 Game options (page 53)
Settings for play fee	7-2-6 Coin options (page 56)
Confirmation of data related to previous game results	7-2-7 Bookkeeping (page 58)
Clock setting	7-2-8 Clock setting (page 59)
Deletion of data, restoration of default settings	7-2-9 Data clear (page 60)

- \* "JVS Status" can be selected only when the Game PC Board is connected to a JAMMA VIDEO Standard (JVS) conforming cabinet.

To make adjustments, use the adjustment switches on the Game PC Board and the switches on the control panel of the cabinet.

The following explains the basic adjustment items such as switches used for adjustments and the methods of making adjustments that are necessary for the game machine operation.



## 7-1 Adjustment



- Remove static electricity from your body before touching the Game PC Board. Static electricity can cause malfunctions or damage.

### 7-1-1 Option switches

The Game PC Board is provided with Option switches (see diagram (1) below). When the JAMMA Connection Kit has been installed, the speaker volume knob (see diagram (2) on the next page) must be also adjusted.

#### (1) Option switches

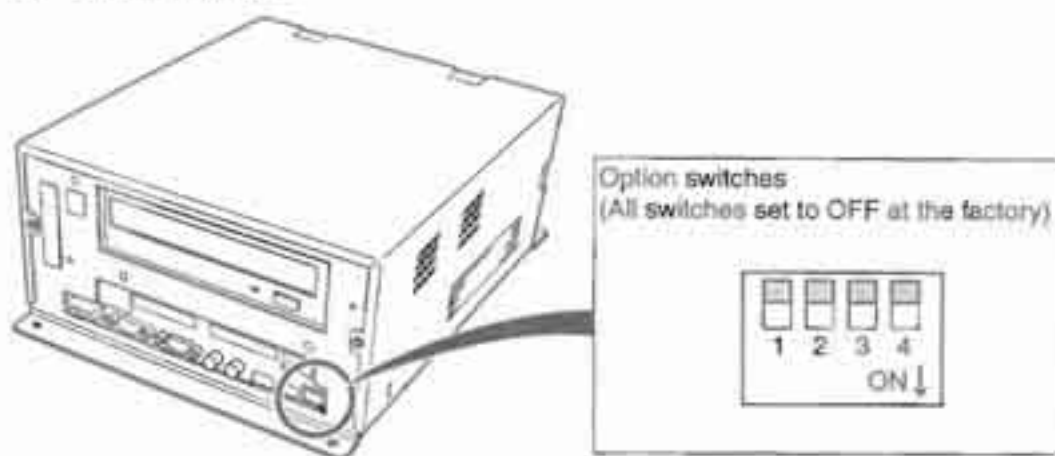

(All Option switches are set to OFF at the factory.)

- Switch 1 is used to change between Test mode and Game mode.

OFF: Test mode	ON: Game mode
----------------	---------------

- Switch 2 is used to change the RGB output level.

OFF: 0.7Vp-p	ON: 0.7Vp-p
OFF: 3.0Vp-p	ON: 0.7Vp-p

\* To be used when installed in JAMMA VIDEO Standard (JVS) conforming cabinet

\* To be used when JAMMA(B) PC Board is installed

- Switch 3 is used to change the horizontal synchronization frequency between 15.75 kHz and 31.5 kHz.\*1

OFF: 15.75kHz	ON: 31.5kHz
---------------	-------------

- Switch 4 is used to change the synchronization signal output type.\*2

OFF: Composite	ON: Separate
----------------	--------------

\*1 When using a 31.5-kHz-compatible cabinet, it is recommended to set to 31.5 kHz. In some cabinets, monitor settings must be adjusted. In that case, refer to the operation manual provided with the cabinet.

\*2 When connecting to the monitor in the cabinet via JAMMA (B) PC Board, be sure to set this switch to Composite.



- When the setting of the Option switch 2, 3 or 4 is changed, turn off the power switch, wait for about 10 seconds, then turn it on again.

(2) Speaker volume (knob) (for JAMMA Standard conforming cabinet only)

The knob is used to adjust the sound level of the speaker in the cabinet.

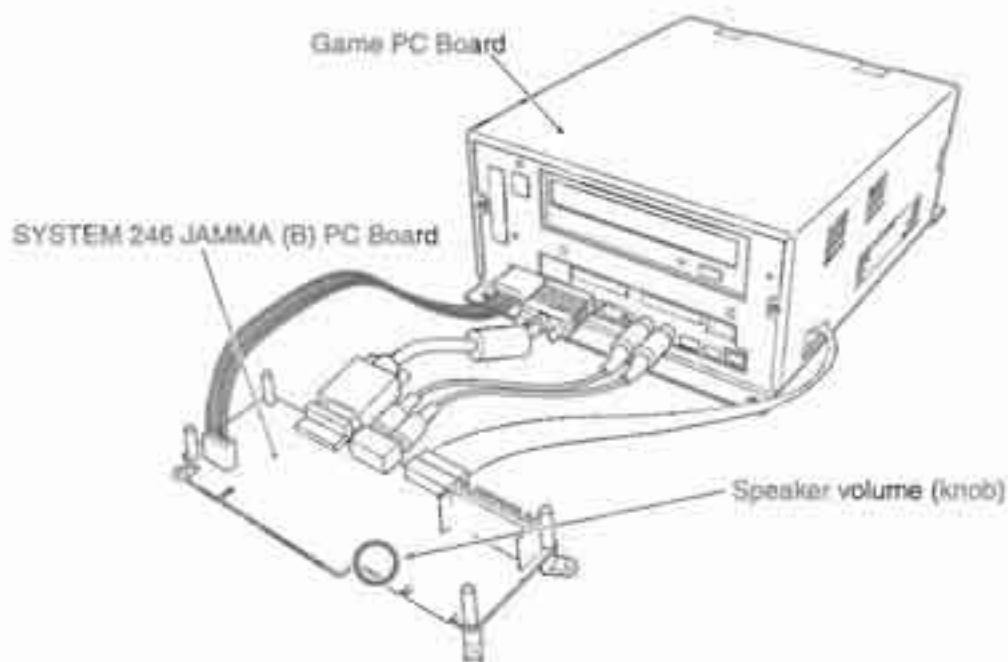

7-1-2 Selection of adjustment item

To make adjustments, switch from the game mode to the test mode, and display the test mode menu screen.

- 1 Turn on the power switch on the cabinet and wait until the Attract screen appears.
- 2 Set the Option switch 1 or the Test switch of the P1-side cabinet to ON. The screen displays adjustment items.



\* If the Option switch or the Test switch of the cabinet is in the ON position before the power switch is turned on, the test mode will not be activated. In that case, set the switch to OFF, then set it to ON.

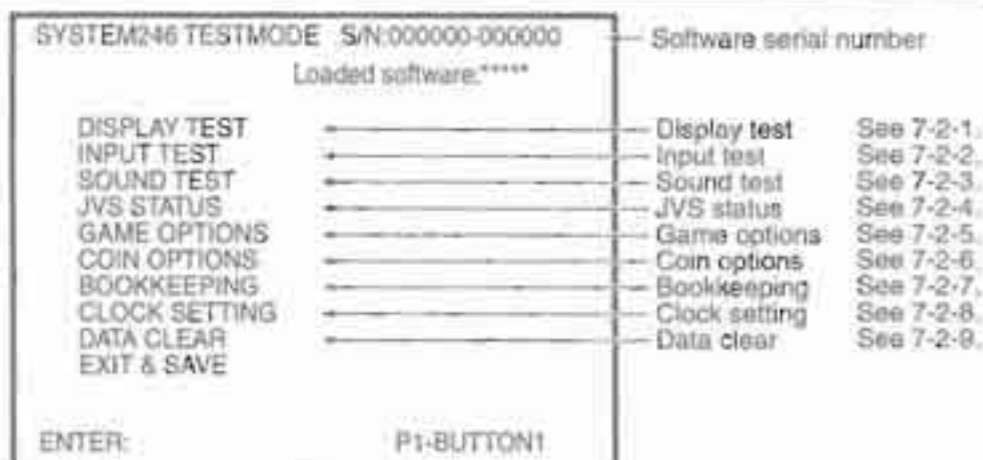

Test mode menu screen

\* "JVS Status" can be selected only when the Game PC Board is connected to a JAMMA VIDEO Standard (JVS) conforming cabinet.

- 3 Select an item by moving the P1 8-direction lever up or down. The selected item is indicated in red.

P1 8-direction lever

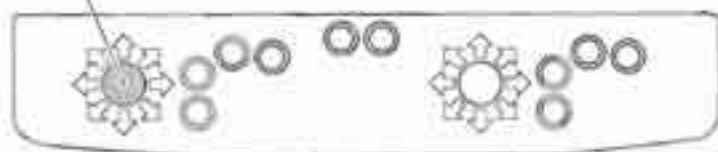

(Note)

The left diagram shows a pair control panel. For a single control panel (when two JAMMA VIDEO Standard (JVS) conforming cabinets are connected for a communication-linked versus game setup), the cabinet mounted with the PC board is the P1 unit.

- 4 Press the P1 Button switch 1 to enter the selection. The screen of the selected adjustment item appears.

P1 Button switch 1

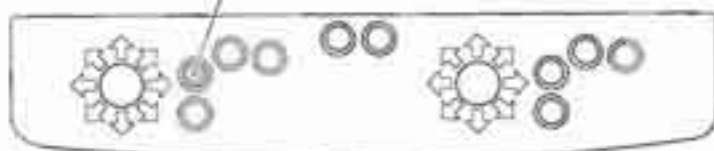

(Note)

The left diagram shows a pair control panel. For a single control panel (when two JAMMA VIDEO Standard (JVS) conforming cabinets are connected for a communication-linked versus game setup), the cabinet mounted with the PC board is the P1 unit.

- 5 Make adjustment for the selected test item. Regarding the adjustment method, refer to the applicable section in "7-2-1 Display test" (page 43) to "7-2-9 Data clear" (page 60).

## 7-1-3 Exiting from test mode

After making necessary adjustments, select "EXIT" to return to the test mode menu screen.

- 1 Move the P1 8-direction lever up or down and change the "Exit & Save" indication to red.

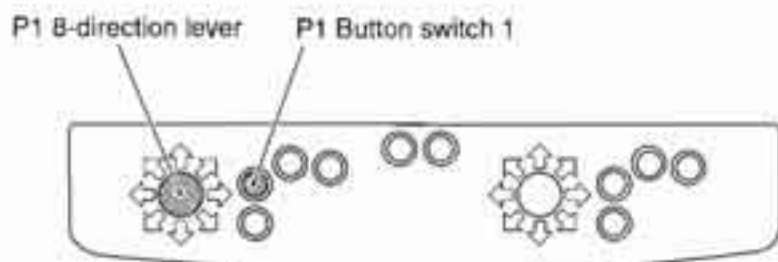

(Note)

The left diagram shows a pair control panel. For a single control panel (when two JAMMA VIDEO Standard (JVS) conforming cabinets are connected for a communication-linked versus game setup), the cabinet mounted with the PC board is the P1 unit.

- 2 Press the P1 Button switch 1.  
The test mode ends, and the display returns to the game screen.
- 3 Set the Option switch 1 or the Test switch of the cabinet to OFF.

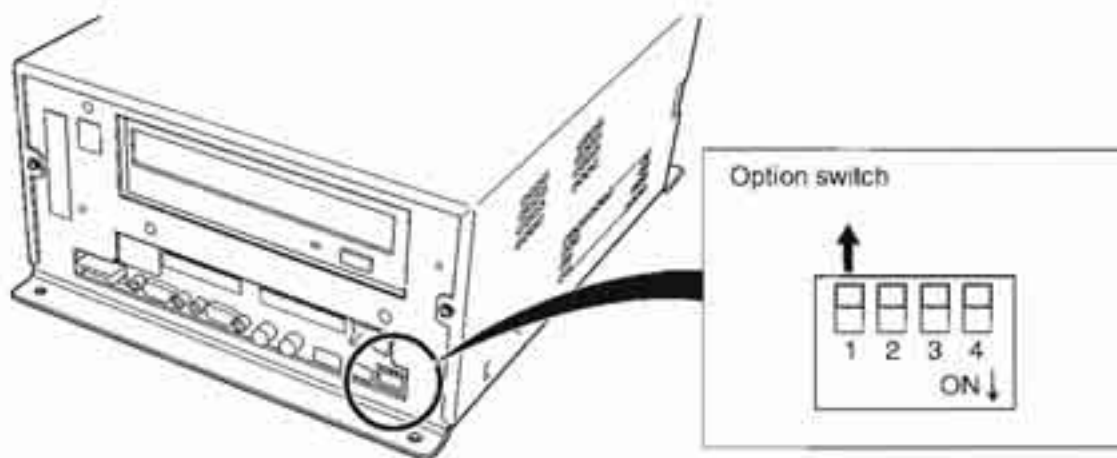

- Be sure to use the method described above to exit from the test mode. If the above procedure is not followed to exit from the test mode, the adjustments (setting changes or new settings) may not be reflected properly.

## 7-2 Test mode

### 7-2-1 Display test (checking and adjusting screen display)

This screen is used to check or adjust the display.

- 1** Select "DISPLAY TEST" on the test mode menu screen (see page 35), and press the P1 Button switch 1 to display the Display Test screen. This test screen allows the following three types of test.

  1. Color bar (see page 44)  
Used to check and adjust the contrast and color balance of the displayed image.
  2. Convergence (see page 46)  
Used to check and adjust the image size, display position, aspect ratio, and distortion.
  3. Interface check (see page 46)  
Used to switch the setting between interlace and non-interlace.  
\* This selection can be made only when the monitor's horizontal synchronization frequency is 15.75 kHz.
- 2** Each time the P1 Button switch 1 is pressed, the displayed screen changes sequentially from above test item 1 to item 3. Select the screen for the item to check or adjust.
- 3** Each time the P1 Button switch 3 is pressed, the color edit mode (see page 44) toggles between ON and OFF. To change the setting for the video signal output from the Game PC Board, set the color edit mode to ON.
- 4** After the checking or adjusting the item, press the P1 Start switch to return to the test mode menu screen (see page 41).
- 5** To exit from the test mode, follow the procedure described in "7-1-3 Exiting from test mode" (page 42).

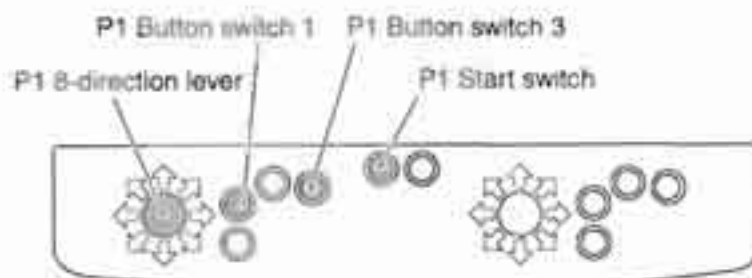

(Note)

The left diagram shows a pair control panel. For a single control panel (when two JAMMA VIDEO Standard (JVS) conforming cabinets are connected for a communication-linked versus game setup), the cabinet mounted with the PC board is the P1 unit.

(1) Color bar and color edit  
(Checking and adjusting image contrast and color balance)

- 1 Display the Color Bar screen by following the steps 1 and 2 in '7-2-1 Display test' (page 43).
- 2 Check to make sure that the color bars are displayed with proper colors and brightness.
- 3 To adjust the contrast or color balance, set the color edit mode must be turned ON. Determine if the color edit mode is ON by referring to the diagrams below. If it is not ON, press the P1 Button switch 3.

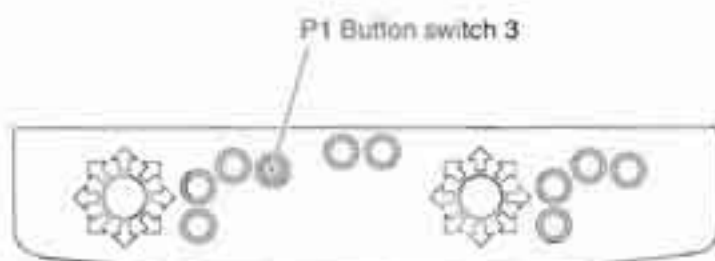

(Note)

The left diagram shows a pair control panel. For a single control panel (when two JAMMA VIDEO Standard (JVS) conforming cabinets are connected for a communication-linked versus game setup), the cabinet mounted with the PC board is the P1 unit.

- The color edit mode toggles between ON and OFF each time the P1 Button switch 3 is pressed.

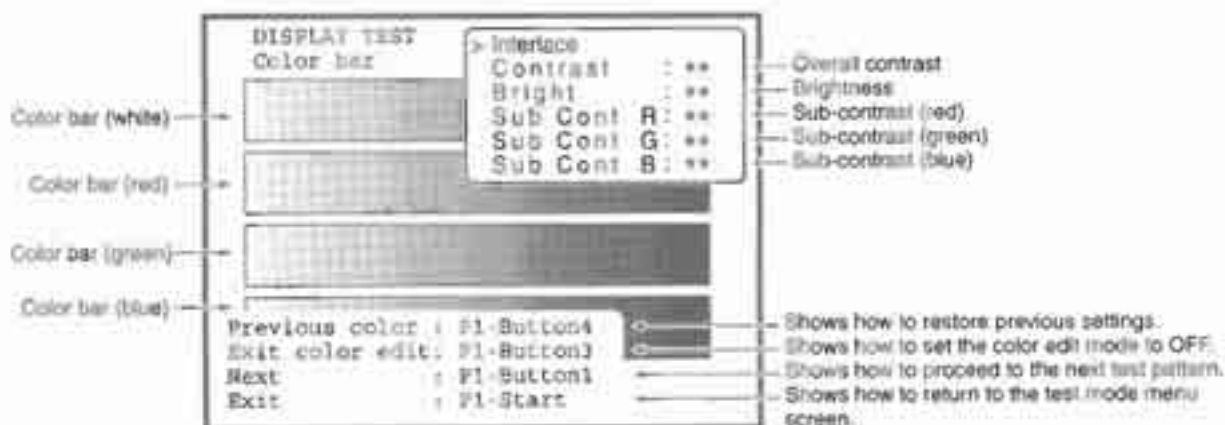

Color Bar screen (when color edit mode is turned ON)

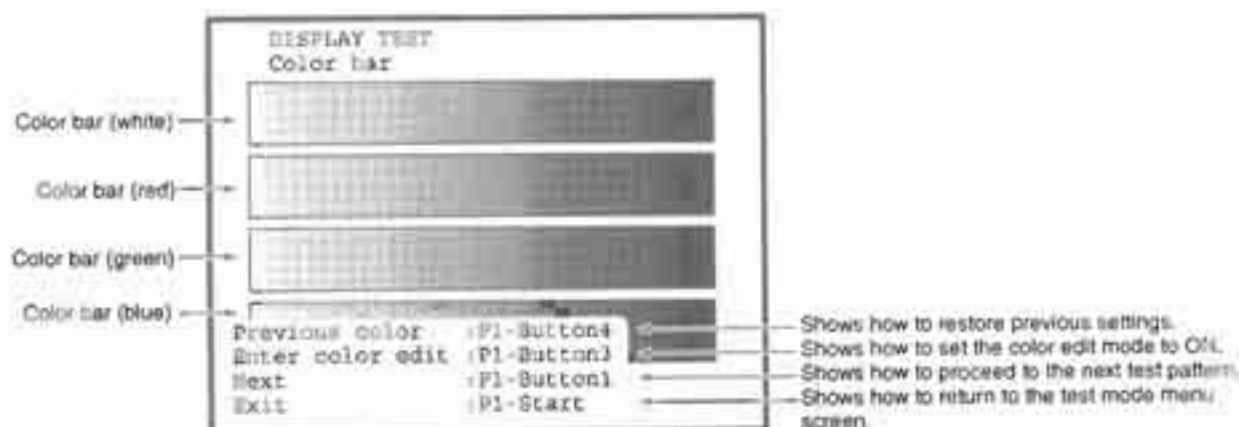

Color Bar screen (when color edit mode is turned OFF)

- 4** By moving the P1 8-direction lever up or down, position the ">" mark at the left side of a desired adjustment item selected from "Contrast," "Bright," "Sub Cont R," "Sub Cont G," and "Sub Cont B."

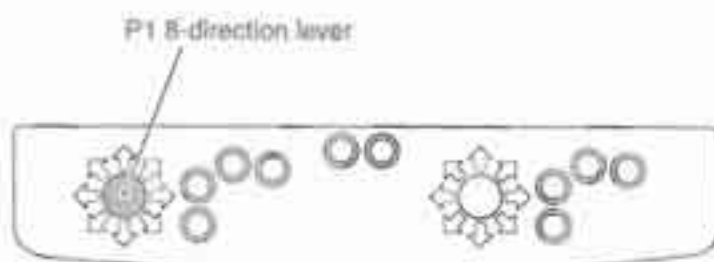

(Note)

The left diagram shows a pair control panel. For a single control panel (when two JAMMA VIDEO Standard (JVS) conforming cabinets are connected for a communication-linked versus game setup), the cabinet mounted with the PC board is the P1 unit.

- 5** Move the P1 8-direction lever to the right or left to change the setting.
- The following adjustments can be made. Check the adjustment results on the color bars displayed on the screen.

Item	Description of adjustment
Contrast	Adjustment of the intensity of the contrast of displayed image
Bright	Adjustment of video signal brightness
Sub Cont R	Fine adjustment of Contrast R (red)
Sub Cont G	Fine adjustment of Contrast G (green)
Sub Cont B	Fine adjustment of Contrast B (red)

- 6** To return the settings to those set at the end of the previous test mode, press the P1 Button switch 4.

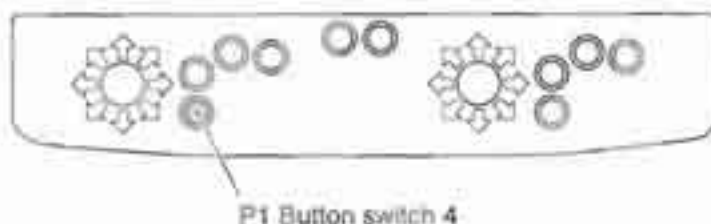

(Note)

The left diagram shows a pair control panel. For a single control panel (when two JAMMA VIDEO Standard (JVS) conforming cabinets are connected for a communication-linked versus game setup), the cabinet mounted with the PC board is the P1 unit.

- 7** To end the Display Test mode completely and return to the test mode menu screen, press the P1 Start switch. To adjust another item in the Display Test mode, press the P1 Button switch 1 and display the screen for the next adjustment item.
- 8** To exit from the test mode, follow the procedure described in "7-1-3. Exiting from test mode" (page 42).

**(2) Convergence**  
 (Checking and adjustment of image size, display position, aspect ratio, and distortion)

- 1** Display the Convergence screen by following the steps **1** and **2** in "7-2-1 Display test" (page 44).
- 2** Check to see if the image display size is correct and there is no distortion in the displayed lattice pattern.  
 \* Conduct adjustments in accordance with the directions in the operation manual of the cabinet.
- 3** To end the Display Test mode completely and return to the test mode menu screen, press the P1 Start switch. To adjust another item in the Display Test mode, press the P1 Button switch 1 and display the screen for the next adjustment item.

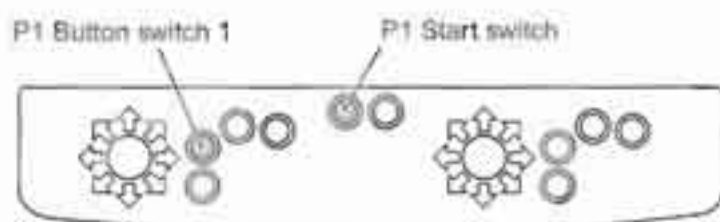

(Note)  
 The left diagram shows a pair control panel. For a single control panel (when two JAMMA VIDEO Standard (JVS) conforming cabinets are connected for a communication-linked versus game setup), the cabinet mounted with the PC board is the P1 unit.

- 4** To exit from the test mode, follow the procedure described in "7-1-3 Exiting from test mode" (page 42).

**(3) Interface check**  
 (Switching mode between interface and non-interface)

\*Only when monitor's horizontal synchronization frequency is 15.75 kHz

**Interface mode:**

This mode provides more detailed graphics and makes curved lines appear smoother than the non-interface mode. In each cycle consisting of two scanning operations, the image display position is shifted a half line in the vertical direction to double the vertical resolution without the change of the horizontal/vertical frequency.

If the monitor does not support the interface mode, noticeable image flicker occurs. In that case, change to the non-interface mode.

**Non-interface mode:**

Set this display mode when the interface mode results in noticeable image flicker over the entire screen. In the non-interface mode, there is no shift of image display position, and the position of image remains constant in every scanning operation.



- 1 Display the Interface Check screen by following the steps 1 and 2 in "7-2-1 Display test" (page 43).
- 2 Check that either "Interface" or "Non Interface" is shown at the upper right corner of the screen.
  - \* If neither "Interface" nor "Non Interface" is shown on the screen, press the P1 Button switch 3 and set the color edit mode to ON.
- 3 Check that "Interface" is indicated at the upper right corner of the screen.
  - \* If "Non Interface" is shown on the screen, change the setting to "Interface" by following the procedure below.
    - 1) By moving the P1 8-direction lever up or down, position the ">" mark at the left side of "Non Interface."
    - 2) Move the P1 8-direction lever to the right or left, change the indication from "Non Interface" to "Interface."

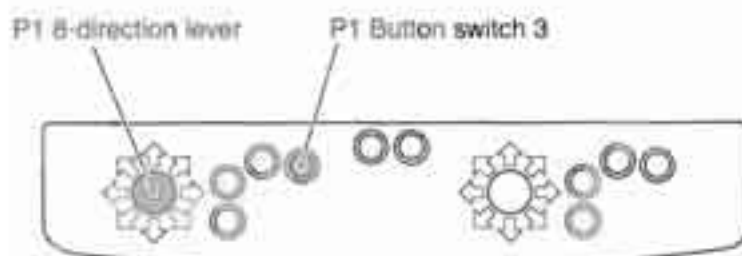

(Note)

The left diagram shows a pair control panel. For a single control panel (when two JAMMA VIDEO Standard (JVS) conforming cabinets are connected for a communication-linked versus game setup), the cabinet mounted with the PC board is the P1 unit.

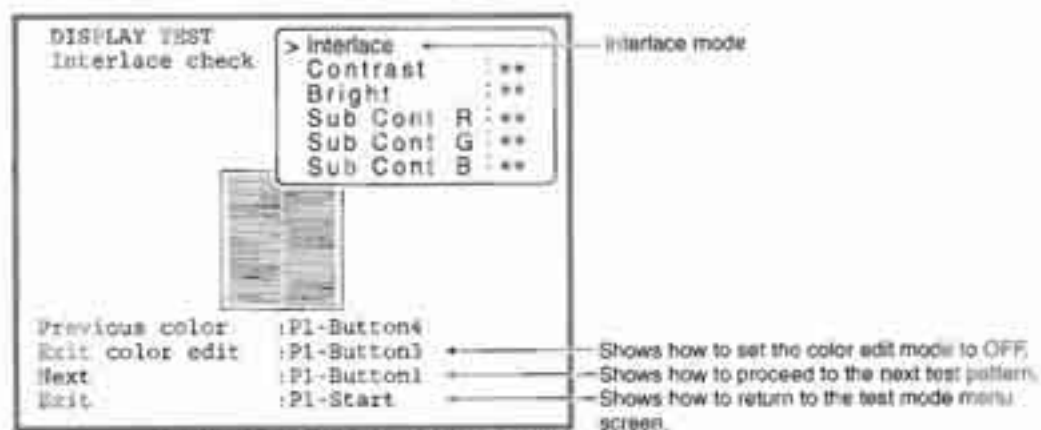

Interface Check screen (in interface mode)

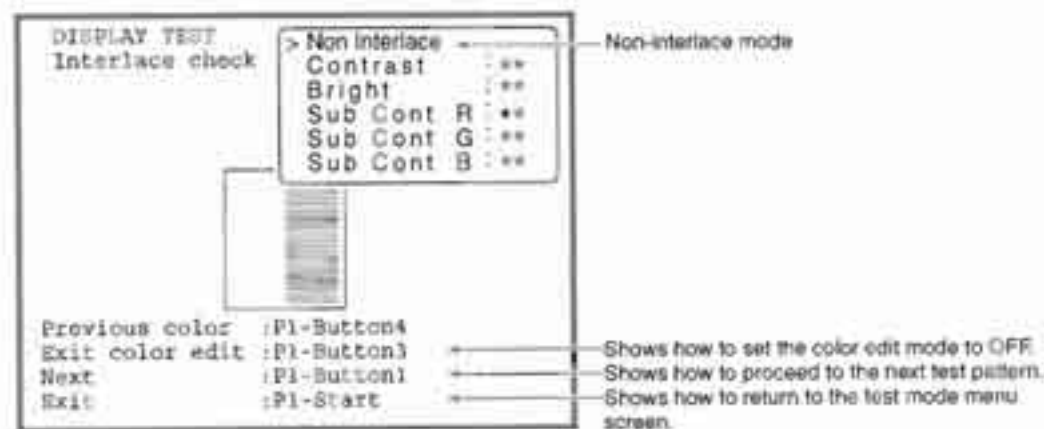

Interface Check screen (in non-interface mode)

- 4** Press the P1 Button switch 3 and check if image flicker occurs over the entire screen.

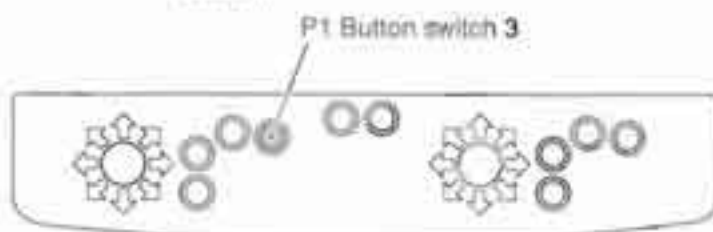

(Note)

The left diagram shows a pair control panel. For a single control panel (when two JAMMA VIDEO Standard (JVS) conforming cabinets are connected for a communication-linked versus game setup), the cabinet mounted with the PC board is the P1 unit.

- \* Each time the P1 Button switch 3 is pressed, the number of screen patterns changes between one and five.
- \* Although the interface mode can display more detailed images than the non-interface mode, it may cause the displayed image to flicker in some monitors, thus disallowing proper image display.
- \* In Soul Calibur III, special technology is used to reduce flicker in displayed game images. Therefore, to evaluate image flicker in the interface mode, be sure to view not only the Interface Check screen but also game images.

- 5** If image flicker occurs over the entire screen, follow the procedure described below to change the "Interface" indication at the upper right corner of the screen to "Non Interface."

- 1) Move the P1 8-direction lever up or down and position the ">" mark at the left side of "Interface."
- 2) Move the P1 8-direction lever to the right or left and change the indication from "Interface" to "Non Interface."

- 6** To end the Display Test mode completely and return to the test mode menu screen, press the P1 Start switch. To perform another adjustment on the Display Test screen, press the P1 Button switch 1 and display the screen for the adjustment item.

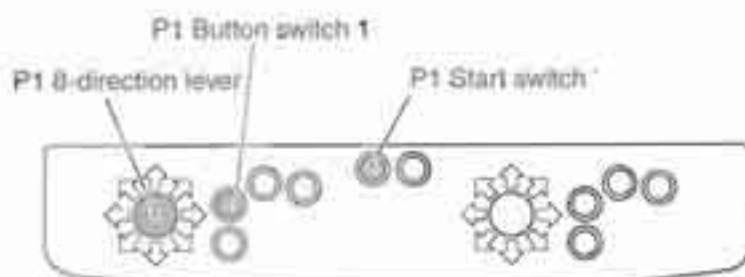

(Note)

The left diagram shows a pair control panel. For a single control panel (when two JAMMA VIDEO Standard (JVS) conforming cabinets are connected for a communication-linked versus game setup), the cabinet mounted with the PC board is the P1 unit.

- 7** To exit from the test mode, follow the procedure described in "7-1-3 Exiting from test mode" (page 42).

### 7-2-2 Input test (switch test)

This screen is used to test the switches connected to the PC board, such as the buttons on the control panel.

- 1 Select "INPUT TEST" on the test mode menu screen (see page 43), and press the P1 Button switch 1 to display the Input Test screen.
- 2 Operate each lever and switch on the control panel, and make sure the corresponding indication on the screen changes to red.

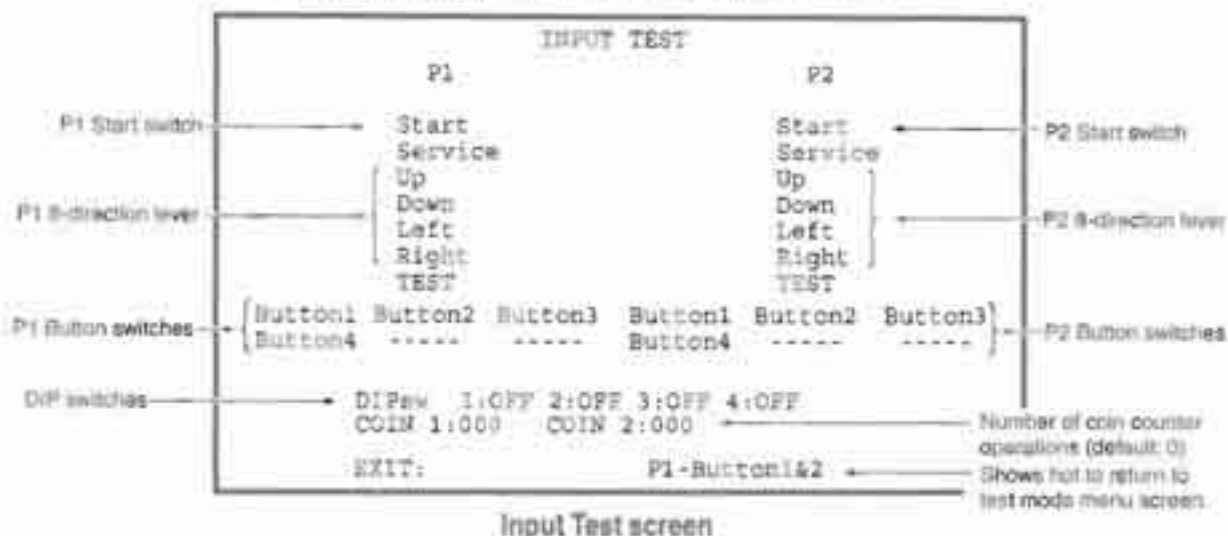

- \* When the levers and button switches on the control panel and the service switches on the cabinet are operated, the corresponding indications on the screen change to red.
- \* The numeric value of COIN 1, COIN 2 increases by one for each operation. The coin counter also operates at the same time.  
(When there is only one coin switch, the COIN 2 indication remains "0.")
- \* In the case of a JAMMA Standard conforming cabinet, the P2 service switch is not displayed.



If the screen indications do not change according to the lever/button operations, the game cannot be played properly. If this happens, refer to "9-2 Troubleshooting" (page 65).

- 3 To return to the test mode menu screen, press the P1 Button switches 1 and 2 simultaneously.

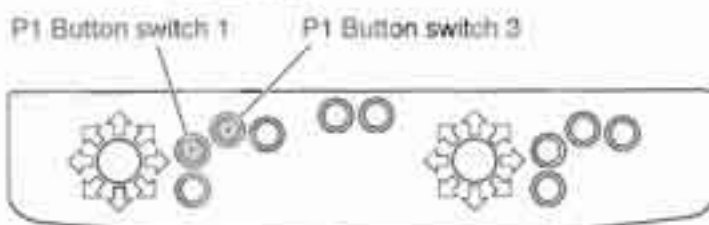

(Note)

The left diagram shows a pair control panel. For a single control panel (when two JAMMA VIDEO Standard (JVS) conforming cabinets are connected for a communication-linked versus game setup), the cabinet mounted with the PC board is the P1 unit.

- 4 To exit from the test mode, follow the procedure described in "7-1-3 Exiting from test mode" (page 42).

## 7-2-3 Sound test

This screen is used to adjust the sound level and conduct a stereo check.

- 1** Select "SOUND TEST" on the test mode menu screen (see page 41), and press the P1 Button switch 1 to display the Sound Test screen.

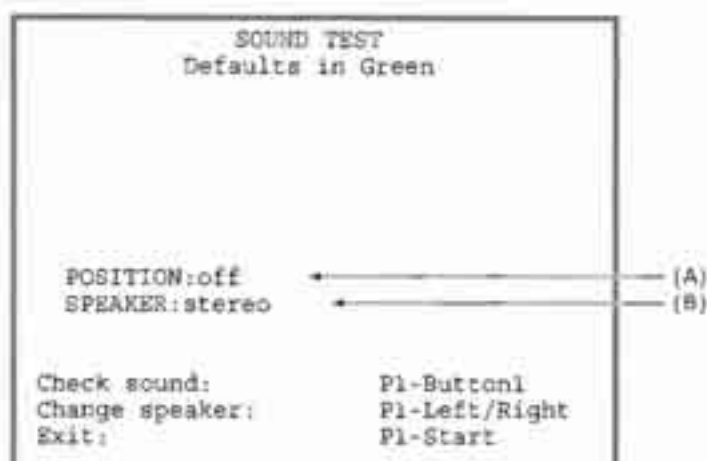

Sound Test screen

- \* Move the P1 8-direction lever to the right or left and change the setting.
- \* Factory settings are indicated in green.

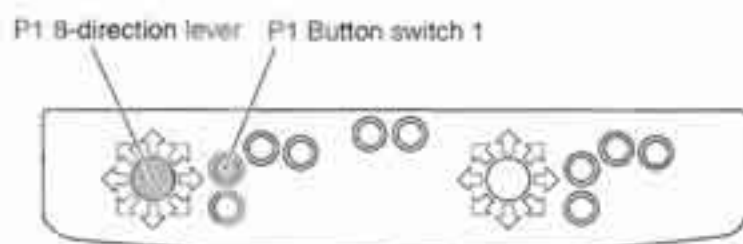

(Note)

The left diagram shows a pair control panel. For a single control panel (when two JAMMA VIDEO Standard (JVS) conforming cabinets are connected for a communication-linked versus game setup), the cabinet mounted with the PC board is the P1 unit.

Sound test settings

Item	Setting options	Factory setting	Remarks
(A) POSITION	Produces a test sound. When the P1 Button switch 1 is pressed, the test sound is produced from the left speaker first, followed by the right speaker, and then by both speakers.		
(G) SPEAKER	[stereo] <-> [monaural]	[stereo]	

- 2** To return to the test mode menu screen, press the P1 Start switch.

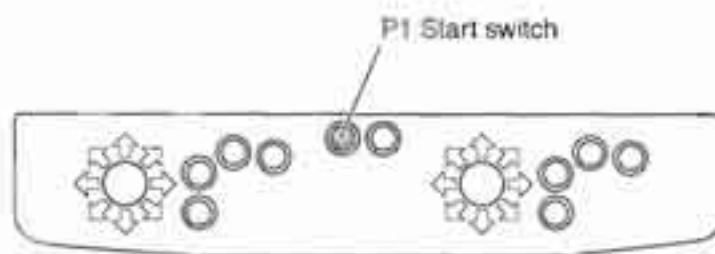

(Note)

The left diagram shows a pair control panel. For a single control panel (when two JAMMA VIDEO Standard (JV5) conforming cabinets are connected for a communication-linked versus game setup), the cabinet mounted with the PC board is the P1 unit.

- 3** To exit from the test mode, follow the procedure described in "7-1-3 Exiting from test mode" (page 42).

## 7-2-4 JVS status

This screen shows the status of the JAMMA VIDEO Standard (JVS) conforming cabinet in use.

- 1 Select "JVS STATUS" on the test mode menu screen (see page 41), and press the P1 Button switch 1 to display the JVS Status screen.
- 2 To return to the test mode menu screen, press the P1 Start switch.

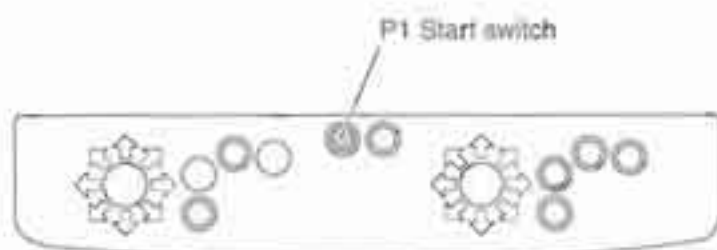

(Note)

The left diagram shows a pair control panel. For a single control panel (when two JAMMA VIDEO Standard (JVS) conforming cabinets are connected for a communication-linked versus game setup), the cabinet mounted with the PC board is the P1 unit.

- 3 To exit from the test mode, follow the procedure described in "7-1-3 Exiting from test mode" (page 42).

## 7-2-5 Game options

This screen is used to set game details.

- 1 Select "GAME OPTIONS" on the test mode menu screen (see page 41), and press the P1 Button switch 1 to display the Game Options screen.
- 2 Operate the levers and button switches on the control panel to select items and make setting changes.



Game Options screen 1



Game Options screen 2

- Move the P1 8-direction lever up or down to select an item, then move the P1 8-direction lever to the right or left to change the setting.
- Factory settings are indicated in green.

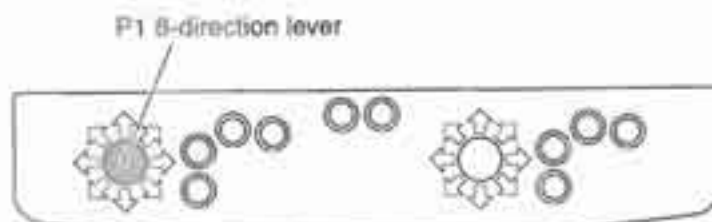

(Note)

The left diagram shows a pair control panel. For a single control panel (when two JAMMA VIDEO Standard (JVS) conforming cabinets are connected for a communication-linked versus game setup), the cabinet mounted with the PC board is the P1 unit.

## Game Options Items

Item	Setting options	Factory setting	Remarks
(A) Difficulty level <Standard>	[EASY] ↔ [NORMAL] ↔ [HARD] ↔ [VERY HARD] ↔ [ULTRA HARD] ↔ [EXTREMEL HARD]	[HARD]	Game difficult level in standard mode
(B) Difficulty level <Legend>	[EASY] ↔ [NORMAL] ↔ [HARD] ↔ [VERY HARD] ↔ [ULTRA HARD] ↔ [EXTREMEL HARD]	[HARD]	Game difficult level in legend mode
(C) Fight count <Standard>	[1] ↔ [2] ↔ [3] ↔ [4] ↔ [5]	[2]	Number of rounds required for winning the game in standard mode
(D) Fight count <VS Game>	[1] ↔ [2] ↔ [3] ↔ [4] ↔ [5]	[2]	Number of rounds required for winning the game in versus game mode
(E) Life bar <Standard>	[80] ↔ [90] ↔ [100] ↔ [110] ↔ [120]	[100]	Energy level in standard mode
(F) Life bar <VS game>	[80] ↔ [90] ↔ [100] ↔ [110] ↔ [120]	[100]	Energy level in versus game mode
(G) Round Time <Standard>	[30] ↔ [35] ↔ [40] ↔ [45] ↔ [50] ↔ [55] ↔ [60]	[40]	Time in one round in standard mode
(H) Round Time <VS game>	[30] ↔ [35] ↔ [40] ↔ [45] ↔ [50] ↔ [55] ↔ [60]	[40]	Time in one round in versus game mode
(I) Round Time <Training>	[200] ↔ [250] ↔ [300] ↔ [400] ↔ [500] ↔ [600]	[300]	Play time in training mode
(J) Neutral guard	[ON] ↔ [OFF]	[OFF]	Guard without guard button pressed
(K) Character change at continue	[ON] ↔ [OFF]	[OFF]	Change of game character for continued game
(L) Character change at VS game	[ON] ↔ [OFF]	[OFF]	Change of game character in versus game mode
(M) Sound in attract mode	[ON] ↔ [OFF]	[ON]	Sound in Attract mode
(N) Stage select <VS game>	[ON] ↔ [OFF]	[OFF]	Change of stage in versus game mode
(O) Event mode	[ON] ↔ [OFF]	[OFF]	Event mode setting*1
(P) Hit Color	[NORMAL] ↔ [MILD]	[MILD]	Color graphic effect of attacks
(Q) Challenger at training	[ON] ↔ [OFF]	[ON]	Acceptance of challenge during game play in training mode
(R) Challenger at legend	[ON] ↔ [OFF]	[ON]	Acceptance of challenge during game play in legend mode

\*1 When this setting is turned ON, the machine starts up in the Event mode. In the Event mode, every game starts in the versus game mode, and the game ends after one tournament.



- 3** To return to the test mode menu screen, press the P1 Start switch.

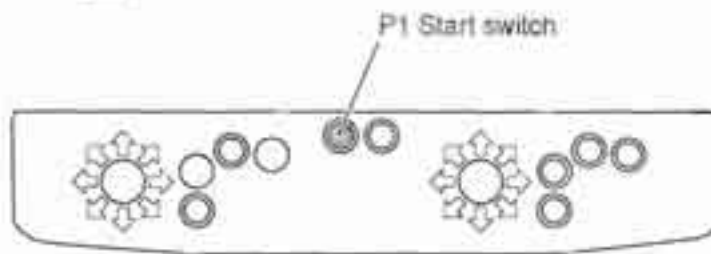

(Note)

The left diagram shows a pair control panel. For a single control panel (when two JAMMA VIDEO Standard (JVS) conforming cabinets are connected for a communication-linked vertus game setup), the cabinet mounted with the PC board is the P1 unit.

- 4** To exit from the test mode, follow the procedure described in "7-1-3 Exiting from test mode" (page 42).

## 7-2-6 Coin options

This screen is used to set the play fee and free play.

- 1 Select "COIN OPTIONS" on the test mode menu screen (see page 41), and press the P1 Button switch 1 to display the Coin Options screen.
- 2 Operate the levers and button switches on the control panel to select items and make changes.

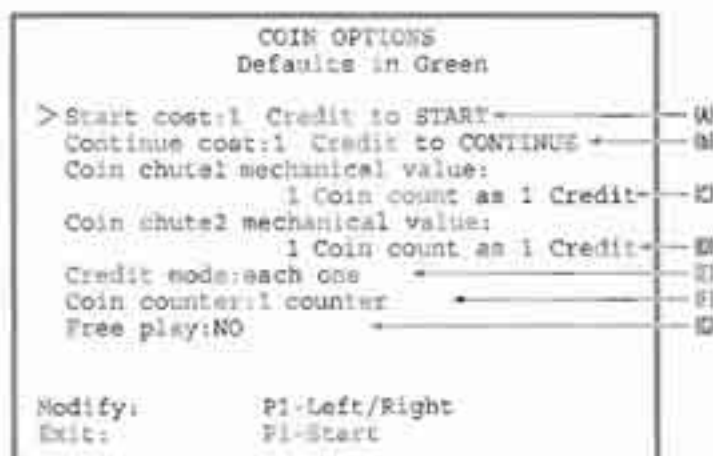

Coin Options screen

- \* Move the P1 8-direction lever up or down to select an item, then move the P1 8-direction lever to the right or left to change the setting.
- \* Factory settings are indicated in green.



(Note)

The left diagram shows a pair control panel. For a single control panel (when two JAMMA VIDEO Standard (JVS) conforming cabinets are connected for a communication-linked versus game setup), the cabinet mounted with the PC board is the P1 unit.

## Coin Options items

Item	Setting options	Factory setting	Remarks
(A) Start cost	[1] ↔ [2] ↔ [3] ↔ [4] ↔ [5] ↔ [6] ↔ [7] ↔ [8] ↔ [9]	[1]	Number of credits required for one new game play
(B) Continue cost	[1] ↔ [2] ↔ [3] ↔ [4] ↔ [5] ↔ [6] ↔ [7] ↔ [8] ↔ [9]	[1]	Number of credits required for one continued game play
(C) Coin chute1 mechanical value	[1] ↔ [2] ↔ [3] ↔ [4] ↔ [5] ↔ [6] ↔ [7] ↔ [8] ↔ [9]	[1]	Number of credits added by one operation of Coin switch 1
(D) Coin chute2 mechanical value	[1] ↔ [2] ↔ [3] ↔ [4] ↔ [5] ↔ [6] ↔ [7] ↔ [8] ↔ [9]	[1]	Number of credits added by one operation of Coin switch 2
(E) Credit mode	[common] ↔ [each one]	[common]	Sets whether credits recorded on Game PC board are to be registered separately for P1 side and P2 side, or jointly. *1
(F) Coin counter	[1 counter] ↔ [2 counter]	[1 counter]	Sets whether operations of Coin switch 1 and Coin switch 2 are counted separately or jointly. *2
(G) Free play	[NO] ↔ [YES]	[NO]	Sets free play.

\*1. In the case of a single JAMMA VIDEO Standard (JVS) conforming cabinet without communication connection, this setting is fixed at "common." When two JAMMA VIDEO Standard (JVS) conforming cabinets are set up for communication-linked versus game, this setting is fixed at "each one."

\*2. In a JAMMA VIDEO Standard (JVS) conforming cabinet, this setting is fixed according to the connection condition since the coin counter is controlled by the cabinet.



- Make sure that the Game PC Board and coin switch 2 are connected. If they are not connected, the P2 side will not accept coins and cannot be used to play the game.

- 3 To return to the test mode menu screen, press the P1 Start switch.

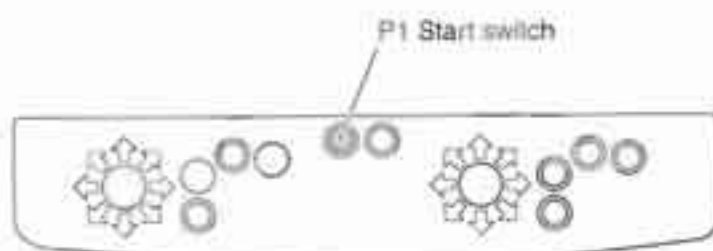

(Note)

The left diagram shows a pair control panel. For a single control panel (when two JAMMA VIDEO Standard (JVS) conforming cabinets are connected for a communication-linked versus game setup), the cabinet mounted with the PC board is the P1 unit.

- 4 To exit from the test mode, follow the procedure described in "7-1-3 Exiting from test mode" (page 42).

### 7-2-7 Bookkeeping

This screen is used to display the cumulative play hours, past play results, and other data.

- 1 Select "BOOKKEEPING" on the test mode menu screen (see page 41), and press the P1 Button switch 1 to display the Bookkeeping screen.
- 2 To return to the test mode menu screen, press the P1 Start switch.

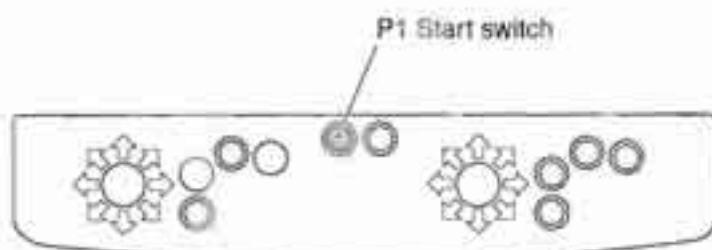

(Note)

The left diagram shows a pair control panel. For a single control panel (when two JAMMA VIDEO Standard (JVS) conforming cabinets are connected for a communication-linked versus game setup), the cabinet mounted with the PC board is the P1 unit.

- 3 To exit from the test mode, follow the procedure described in "7-1-3 Exiting from test mode" (page 42).

## 7-2-8 Clock setting

This screen is used to set the internal clock of the Game PC Board.

- The internal clock of the product must be set correctly in order to save the results of game plays in the Legend mode.  
Regarding the Legend mode, refer to the explanation board.

- Select "CLOCK SETTING" on the test mode menu screen (see page 41), and press the P1 Button switch 1 to display the Clock Setting screen.

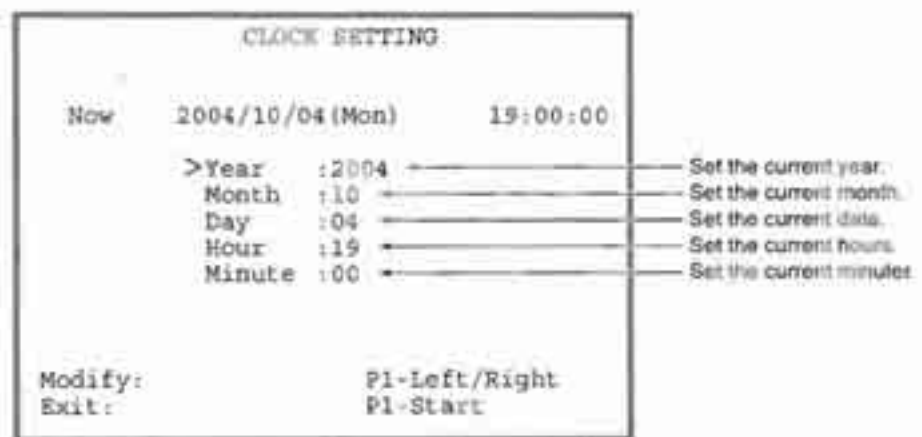

Clock Setting screen (date and time setting)

- Move the P1 8-direction lever up or down to select an item, then move the P1 8-direction lever to the right or left to change the setting.
- To return to the previous screen, press the P1 Start switch.
- The day-of-the-week indication is automatically adjusted when the "Year," "Month" and "Day" are changed.

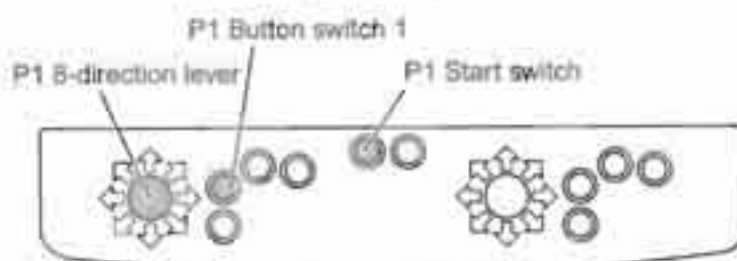

(Note)

The left diagram shows a pair control panel. For a single control panel (when two JAMMA VIDEO Standard (JVS) conforming cabinets are connected for a communication-linked versus game setup), the cabinet mounted with the PC board is the P1 unit.

- To return to the test mode menu screen, press the P1 Start switch.

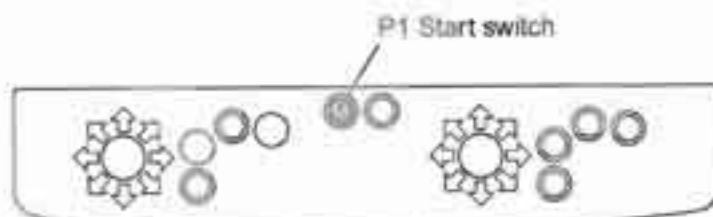

(Note)

The left diagram shows a pair control panel. For a single control panel (when two JAMMA VIDEO Standard (JVS) conforming cabinets are connected for a communication-linked versus game setup), the cabinet mounted with the PC board is the P1 unit.

- To exit from the test mode, follow the procedure described in "7-1-3 Exiting from test mode" (page 42).

## 7-2-9 Data clear

This screen is used to delete various stored data and to restore initial settings.

- 1** Select "DATA CLEAR" on the test mode menu screen (see page 41), and press the P1 Button switch 1 to display the Data Clear screen.

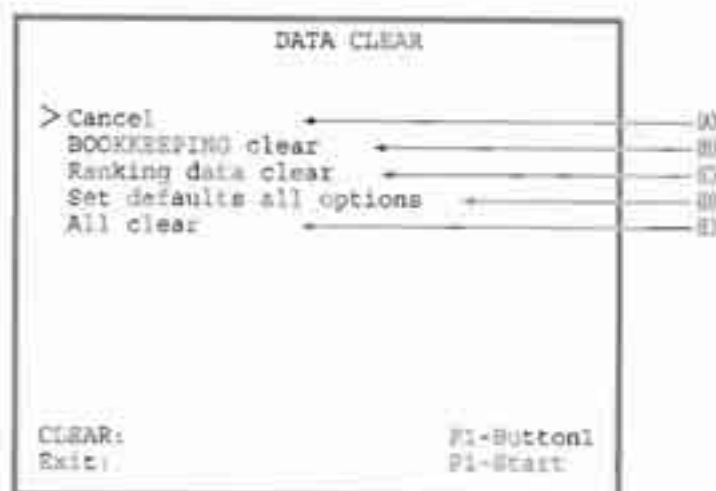

Data Clear screen

- \* Move the P1 8-direction lever up or down and select an item, and press the P1 Button switch 1 to enter the selection. The display will show a setting confirmation screen.

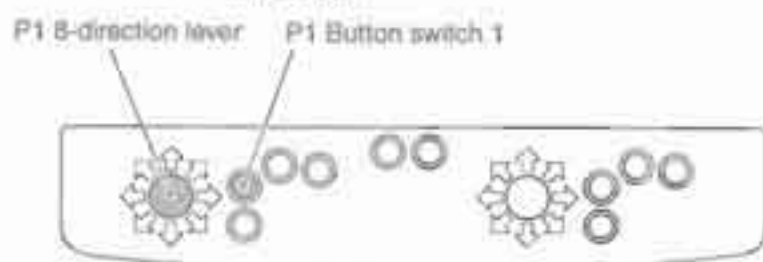

(Note)

The left diagram shows a pair control panel. For a single control panel (when two JAMMA VIDEO Standard (JVS) conforming cabinets are connected for a communication-linked versus game setup), the cabinet mounted with the PC board is the P1 unit.

## Data Clear settings

Item	Description	Remarks
(A) Cancel	Cancels the current mode and displays the test mode menu.	
(B) Bookkeeping clear	Initializes the bookkeeping data.	
(C) Ranking data clear	Initializes the record of consecutive wins.	
(D) Set defaults all options	Returns the settings to defaults.	
(E) All clear	Returns all data and settings to defaults.	

- 2** To return to the test mode menu screen, press the P1 Start switch.

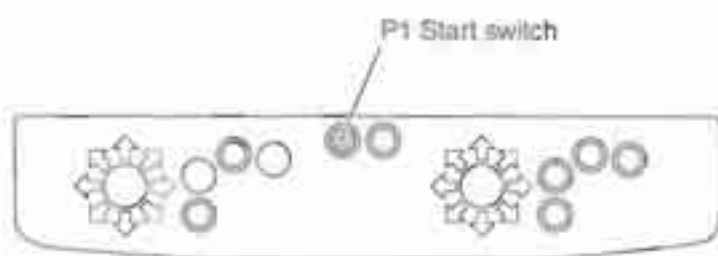

(Note)

The left diagram shows a pair control panel. For a single control panel (when two JAMMA VIDEO Standard (JVS) conforming cabinets are connected for a communication-linked versus game setup), the cabinet mounted with the PC board is the P1 unit.

- 3** To exit from the test mode, follow the procedure described in "7-1-3 Exiting from test mode" (page 42).

## 8. MAINTENANCE

---

### WARNING

- Should a problem occur, such as an abnormal odor and noise, turn off the power switch on the cabinet immediately and stop the machine operation. Then, unplug the power cord of the cabinet from the electrical outlet, and contact your distributor. Operating the machine with a problem left uncorrected may cause an electric shock or fire.
- If it is necessary to touch the PC board while the machine is in operation, refer to "9. INSPECTION, CLEANING AND TROUBLESHOOTING" on page 64.
- Make sure that the product has been installed and connected according to the directions and procedures ("5. INSTALLATION AND CONNECTION (for JAMMA VIDEO Standard (JVS) conforming cabinet)" on page 11 and "6. INSTALLATION AND CONNECTION (for JAMMA Standard conforming cabinet)" on page 22). Incorrect installation or connection can cause a fire, electric shock or malfunction.



## 8-1 Operating environment

### WARNING

- Do not operate the product outdoors. This product is designed for indoor use only. Outdoor use of the product can result in an electric shock or fire.



- Do not operate the product outdoors. This product is designed for indoor use only. Outdoor use of the product can result in an electric shock or fire.
- Be sure to observe the operating environment described in "2. SPECIFICATIONS" on page 7. Failure to meet the specified requirements can result in a malfunction and damage
- Do not operate the product in any of the following places to prevent malfunctions and damage.
  - Places where rain or water can leak
  - Damp places
  - Dusty places
  - Close to heating devices such as room heaters
  - Places where dew condensation may occur due to temperature differences
  - Places where vibrations are generated
  - Places where flammable or volatile materials are stored nearby
  - Places close to sources of strong magnetism or radiowaves

## 8-2 Play instructions

### Manipulating the game character

Game characters and operation instructions are described on the explanation board, technique explanation sticker (A) and Technique explanation sticker (B).

### Description of game modes

The game system and modes are described on the explanation board.

## 9. INSPECTION, CLEANING AND TROUBLESHOOTING

- To be conducted by a technician only -

### 9-1 Inspection and cleaning

#### WARNING

- Before inspecting or cleaning, unplug the power cord from the electrical outlet to prevent an electric shock.
- To prevent an electric shock, do not perform any work with wet hands.

To ensure proper operation of the product, conduct inspection and cleaning regularly according to the following table.

Frequency	Description	Reference page	Caution
Periodic inspection	<ul style="list-style-type: none"><li>● Check to make sure that the PC board and connectors are installed and connected securely. Vibrations generated during game play can result in loose installation or connection. If the machine continues to be used in that condition, equipment damage or malfunctions can result.</li></ul>	"5. INSTALLATION AND CONNECTION (for JAMMA VIDEO Standard (JVS) conforming cabinet)" (page 11) "6. INSTALLATION AND CONNECTION (for JAMMA Standard conforming cabinet)" (page 22)	To be conducted by a technician only
	<ul style="list-style-type: none"><li>● Check to make sure that the cabinet, harnesses and cables do not contact the PC board. Operating the product with the PC board in contact with such parts can cause malfunctions or damage.</li></ul>	"5. INSTALLATION AND CONNECTION (for JAMMA VIDEO Standard (JVS) conforming cabinet)" (page 11) "6. INSTALLATION AND CONNECTION (for JAMMA Standard conforming cabinet)" (page 22)	To be conducted by a technician only
Every 6 months	<ul style="list-style-type: none"><li>● Conduct the display, switch and sound output tests.</li></ul>	"7-2-1 Display test" (page 43) "7-2-2 Input test" (page 49) "7-2-3 Sound test" (page 50)	
	<ul style="list-style-type: none"><li>● Clean the PC board. Foreign items and dust accumulated on the PC board can cause malfunctions or damage.</li></ul>	"5. INSTALLATION AND CONNECTION (for JAMMA VIDEO Standard (JVS) conforming cabinet)" (page 11) "6. INSTALLATION AND CONNECTION (for JAMMA Standard conforming cabinet)" (page 22)	To be conducted by a technician only



- Remove static electricity from your body before touching the PC board. Static electricity can cause malfunctions or damage.
- Use anti-static cleaning equipment for cleaning. Static electricity can damage the ICs on the PC board and render the PC board useless.
- Do not use any liquid such as water or detergent to clean the product. Liquids can cause malfunctions or damage.
- Do not conduct a continuity test using a tester. The internal voltage in a tester can damage the ICs on the PC board and render the PC board useless.
- Do not replace the built-in battery in a Game PC Board other than the SYSTEM 246 Rack (B) Assy. Replacing the built-in battery can cause malfunctions or damage.

## 9-2 Troubleshooting

### WARNING

- Before checking the product for proper installation and connection, turn off the power switch on the cabinet and unplug the power cord from the electrical outlet to prevent an electric shock.
- Should a problem occur, such as an abnormal odor and noise, turn off the power switch on the cabinet immediately and stop the machine operation. Then, unplug the power cord of the cabinet from the electrical outlet, and contact your distributor. Operating the machine with a problem left uncorrected may cause an electric shock or fire.



- Do not replace the built-in battery in a Game PC Board other than the SYSTEM 246 Rack (B) Assy. Replacing the built-in battery can cause malfunctions or damage.
- Never attempt to disassemble the Game PC Board.

If the product does not operate properly or a malfunction occurs, follow the procedure described below to check the cause of the problem.

- 1** Turn off the power switch on the cabinet, and unplug the power cord from the electrical outlet.
- 2** Remove foreign items and dust from the Game PC Board.



- Remove static electricity from your body before touching the Game PC Board. Static electricity can cause malfunctions or damage.
- Use anti-static cleaning equipment for cleaning. Static electricity can damage the ICs on the PC board and render the PC board useless.

- 3** Check again to make sure that the product is installed and connected properly in the cabinet.  
Refer to the operation manual of the cabinet and "5. INSTALLATION AND CONNECTION (for JAMMA VIDEO Standard (JVS) conforming cabinet)" (page 11) and "6. INSTALLATION AND CONNECTION (for JAMMA Standard conforming cabinet)" (page 22) in this manual.)



- Do not conduct a continuity test using a tester. The internal voltage in a tester can damage the ICs on the PC board and render the PC board useless.

- 4** Plug the power cord plug into the electrical outlet, and turn on the power switch on the cabinet.
- 5** Check all the adjustments and settings again. (Refer to "7. ADJUSTMENT FOR OPERATION" (page 38) in this manual.)

Symptom	Possible cause	Action
The machine does not operate when the power switch on the cabinet is turned on.	Power supply is not connected properly to the cabinet.	Check to make sure that the power cord of the cabinet is connected properly.
	Power supplied from the cabinet does not meet the input power requirements of the Game PC Board.	Make sure that the power supply in the cabinet conforms to the requirements listed in "2. SPECIFICATIONS" (page 7).
"SYSTEM 256 MODE SETTING ERROR" appears on the screen when the machine starts.	The mode is set incorrectly on the Game PC Board (SYSTEM 256).	Change the setting to "246+ Mode" by referring to "9-2-1 Mode change" (page 67) in this manual.
Error indication for low battery power appears on the screen.	The battery in the Game PC Board has run out.	If the Game PC Board is the SYSTEM 246 Rack (B) Assy, change the battery by referring to its operation manual.*1 Other Game PC Boards are installed with rechargeable batteries. Therefore, there is no need to replace the battery.*2
Error indication for improper clock setting appears on the screen.	The internal clock of the Game PC Board is not set correctly.	Set the clock correctly by referring to "7-2-8 Clock setting" (page 59) in this manual.

\*1 After replacing the battery, set the internal clock by referring to "7-2-8 Clock setting" (page 59) in this manual.

\*2 After operating the Game PC Board for a while (about 10 minutes), set the internal clock by referring to "7-2-8 Clock setting" (page 59) in this manual.

- 6** If the problem remains after completing the steps **1** through **5**, the Game PC Board or cabinet may be defective. Turn off the power switch on the cabinet, and unplug the power cord from the electrical outlet. Install the product in another cabinet which is known to operate properly, and conduct the above procedure again for operation check. If the same problem occurs, the Game PC Board is most likely defective. Contact your distributor.

### 9-2-1 Mode change

The SYSTEM 256 PC Board can operate in the "256 Mode" or "246+ Mode." If "MODE SETTING ERROR" appears when the machine starts, change the mode by following the procedure described below.



- The following work must be conducted by a technician.
- Make sure that the person conducting the work is not charged with static electricity. Static electricity can cause malfunctions or damage to the product
- Do not perform a continuity test using a tester. Internal voltage of a tester can damage the ICs on the PC board and render the PC board useless.

### CAUTION

- When it is necessary to work in a dark area inside the main unit, use a flash light or an appropriate light source to illuminate the area.

- 1 Remove the two Phillips pan-head screws (with flat and spring washers) (M3 x 6) from the front side of the Game PC Board, pull the cover toward the front for a distance of about 2 cm, disengage the claws (4 locations), and then lift the cover to remove.

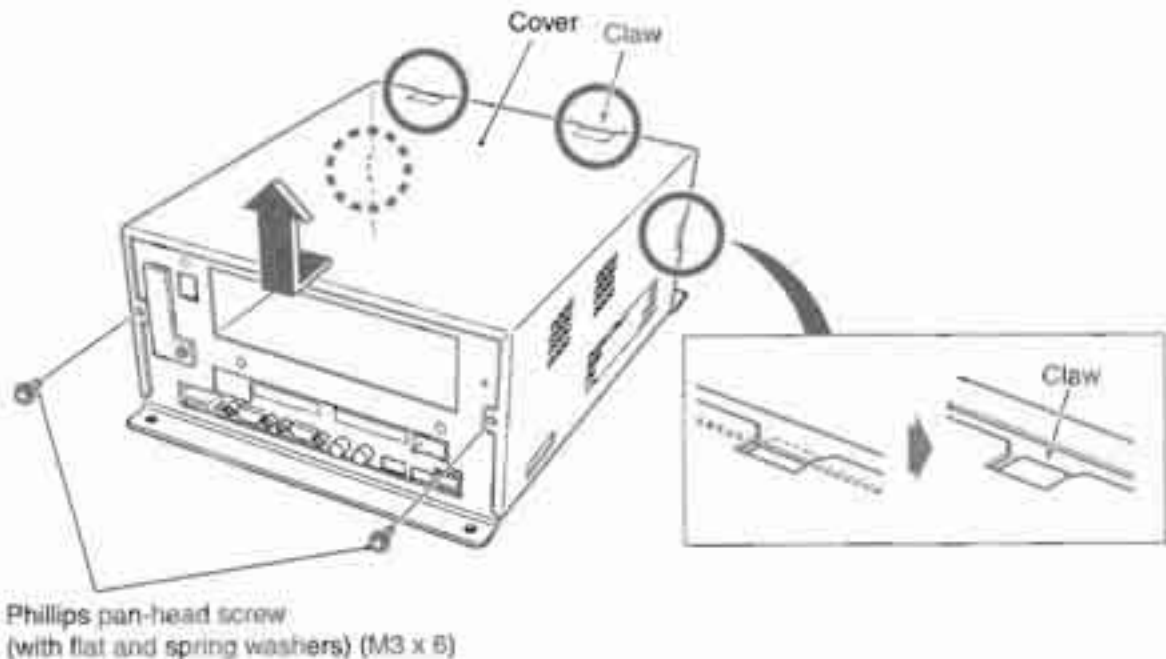

- 2** Make sure that the mode selector switch (jumper socket) is installed.

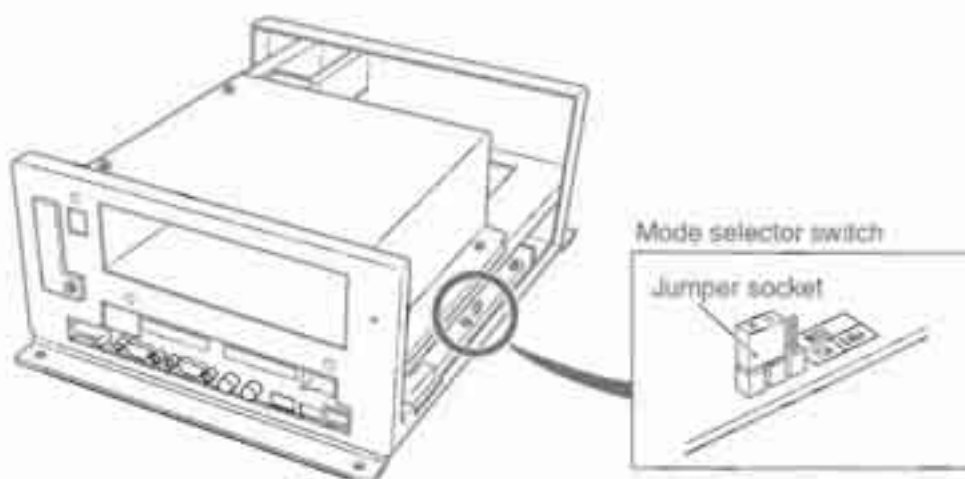

- 3** Change the jumper socket installation position to switch to the appropriate mode.

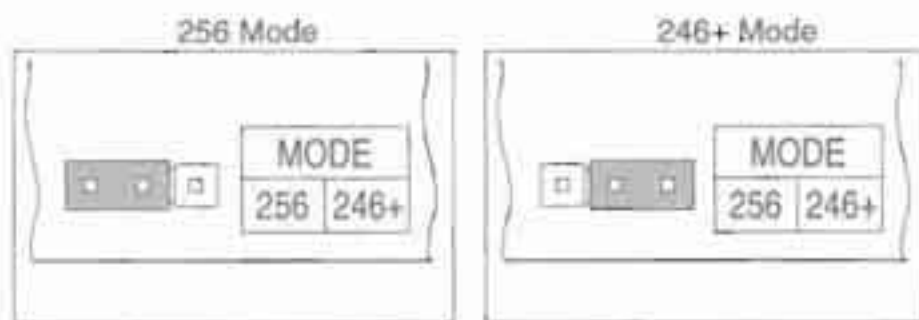

- 4** Reinstall the cover by following the removal sequence in reverse. In this step, make sure that the claws (4 locations) are engaged with the case.

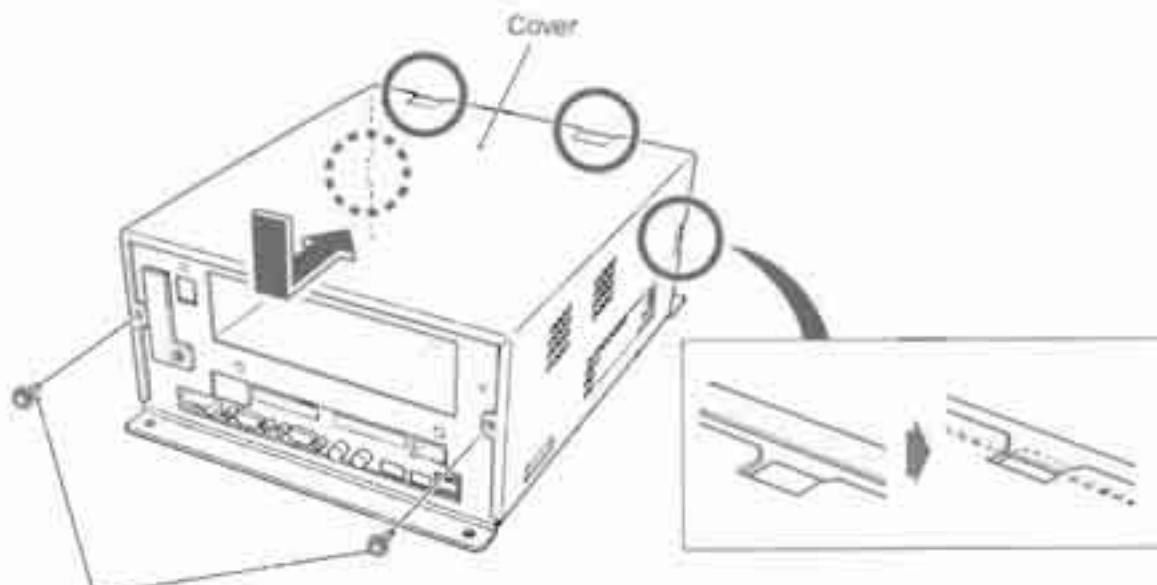

Phillips pan-head screw  
(with flat and spring washers) (M3 x 6)

## 10. REMOVAL, STORAGE AND TRANSPORTATION

---

### 10-1 Removal - To be conducted by a technician only -

To remove the PC board from the cabinet, follow the directions described in the operation manual of the cabinet.

### 10-2 Storage

After removing the PC board, repack the product using the packing materials that came with the product, and store it in a clean and dry place. Do not place any heavy item on the product.



- Do not store the product in any of the following places to prevent product malfunctions.
  - Place exposed to direct sunlight
  - Place where rain or leaked water may contact the product
  - Damp place
  - Dusty place
  - Close to heating devices such as room heaters
  - Place where dew condensation may occur due to temperature differences
  - Place where vibrations are generated
  - Place where flammable or volatile materials are stored nearby

### 10-3 Transportation

When transporting the product for transfer of ownership, resale or repair, use the packing materials that came with the product to protect the product from external force and impact.

## 11. DISCARDING THE PRODUCT

---

### WARNING

- Never not throw the product into flames. The lithium battery and electronic parts contained in the product can explode and cause injuries if the product is heated to high temperatures.
- When discarding the product, be sure to collect, transport and dispose of the product according to the law.
- When entrusting another party to collect, transport and disposed of the product or other work, be sure to use a company specializing in the particular work to be assigned.



#### NOTICE

- When discarding the product, break the DVD-ROM provided with the product into halves to disallow its use, and dispose of it together with the product.

The DVD-ROM supplied with the product must not be copied, modified, distributed, or used for purposes other than the operation of the product. The contents of the DVD-ROM are protected by copyright laws. Infringement of copyright laws may subject persons to criminal penalties.

Do not use the supplied DVD-ROM in any other product models or media formats. Doing so may result in equipment failure.



## 12. REPAIR PARTS LIST

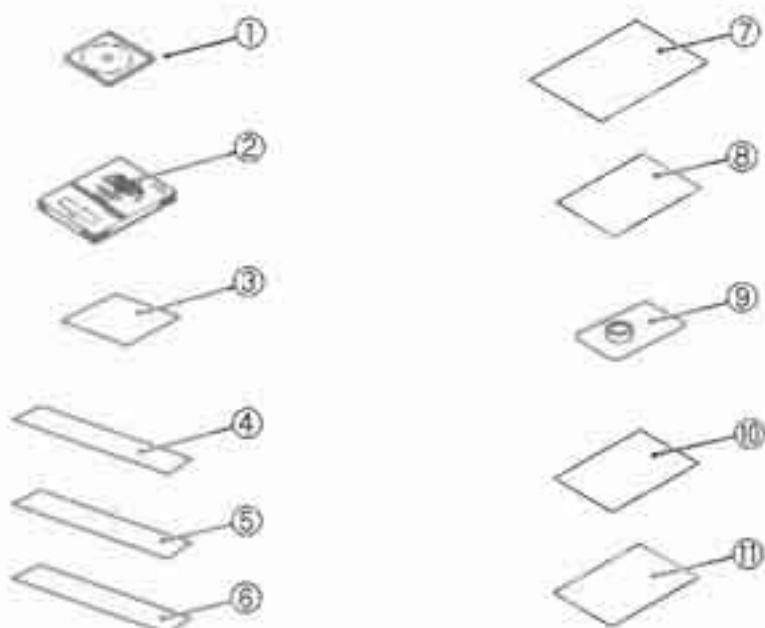

No.	Name	Qty	Type and rating	Parts No.
1	DVD-ROM	1	(For use for SOUL CALIBUR III ARCADE EDITION only)	717-116
2	SOUL CALIBUR III ARCADE EDITION Operation Manual	1	This operation manual	717-117
3	Title board	2		717-101
4	Explanation board E	2		717-118
5	Technique explanation sticker (A) E	2		717-119
6	Technique explanation sticker (B) E	2		717-120
7	Button sticker	1		717-112
8	Soul Calibur III S 245 B explanation board E	1		717-121
9	Battery	1		---
10	Procedure for changing the battery	1		717-122
11	Procedure for changing the DVD-ROM drive	1		717-123

© NAMCO LIMITED

Part No.: 717-117  
First Edition Published in March 2006