

CIRCUIT MOLEX PLUG

RED-BLK

#1895

#1895

D DOT

Y-GRN AUDIO (VOL. CONT.)

ORN AUDIO COMMON (21)

0" QUICK CONNECT (2)

ILY - ALL MODELS

BLK-WHT



BLK-WHT



SED ONLY
ODEL

TO GAME
P.C. BOARD
ASSEMBLY

POWER GRND.	ORN-WHT	A
COIN SW. COMMON	BLK-ORN	I
	BLK	B
+5V.	PINK	2
+5V.	PINK	C
+5V.	PINK	3
+5V.	PINK	D
	N.C.	E
	N.C.	5
	N.C.	F
	N.C.	6
PLAY 2 DOWN	GRY-ORN	H
	N.C.	7
COINS	ORN	J
PLAYER 2 UP	GRY-BLK	8
PLAYER 1 DOWN	TAN-BLU	K
PLAYER 1 UP	TAN-BLK	9
1 PLAYER START	TAN	L
2 PLAYER START	GRY	10
PLAY 1 LEFT	TAN-RED	M
PLAYER 1 RIGHT	TAN-GRN	11
PLAYER 1 FIRE	TAN-YEL	N
PLAYER 2 FIRE	GRY-YEL	12
PLAYER 2 LEFT	GRY-RED	P
PLAYER 2 RIGHT	GRY-GRN	13
COCKTAIL OPER.	WHT	R
COIN 2	GRN-WHT	14
	N.C.	S
	N.C.	15
PIX-RED	YEL-RED	T
PIX-GRN	YEL-GRN	16
PIX-BLU	YEL-BLU	U
PIX-SYNC	YEL-BRN	17
	N.C.	V
AUDIO OUTPUT	YEL-BLK	18
+12V.	RED	W
+12V.	RED	19
+12V.	RED	X
+12V.	RED	20
LOGIC COMMON	BLK-WHT	Y
AUDIO COMMON	VIO-ORN	21
POWER GRND	ORN-WHT	Z
		22

44 CIRCUIT
AMP- LEAF
22 DUAL
SOCKET

UIT
CKET
I)

8 Ω
LOUDSPEAKER

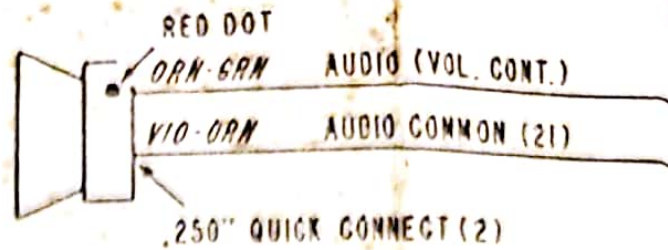

KEYBOARD ASSEMBLY - ALL MODELS

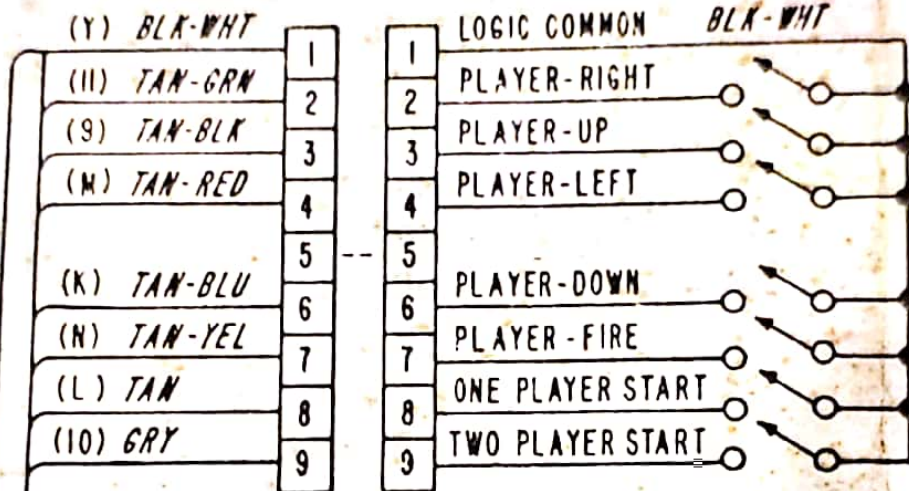

9 CIRCUIT MOLEX PLUGS

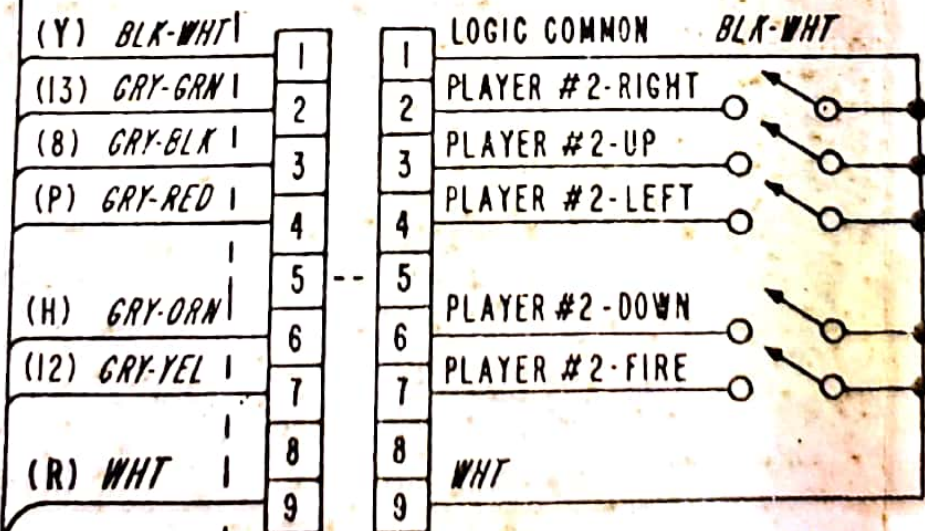

THIS KEYBOARD USED ONLY
WITH COCKTAIL MODEL

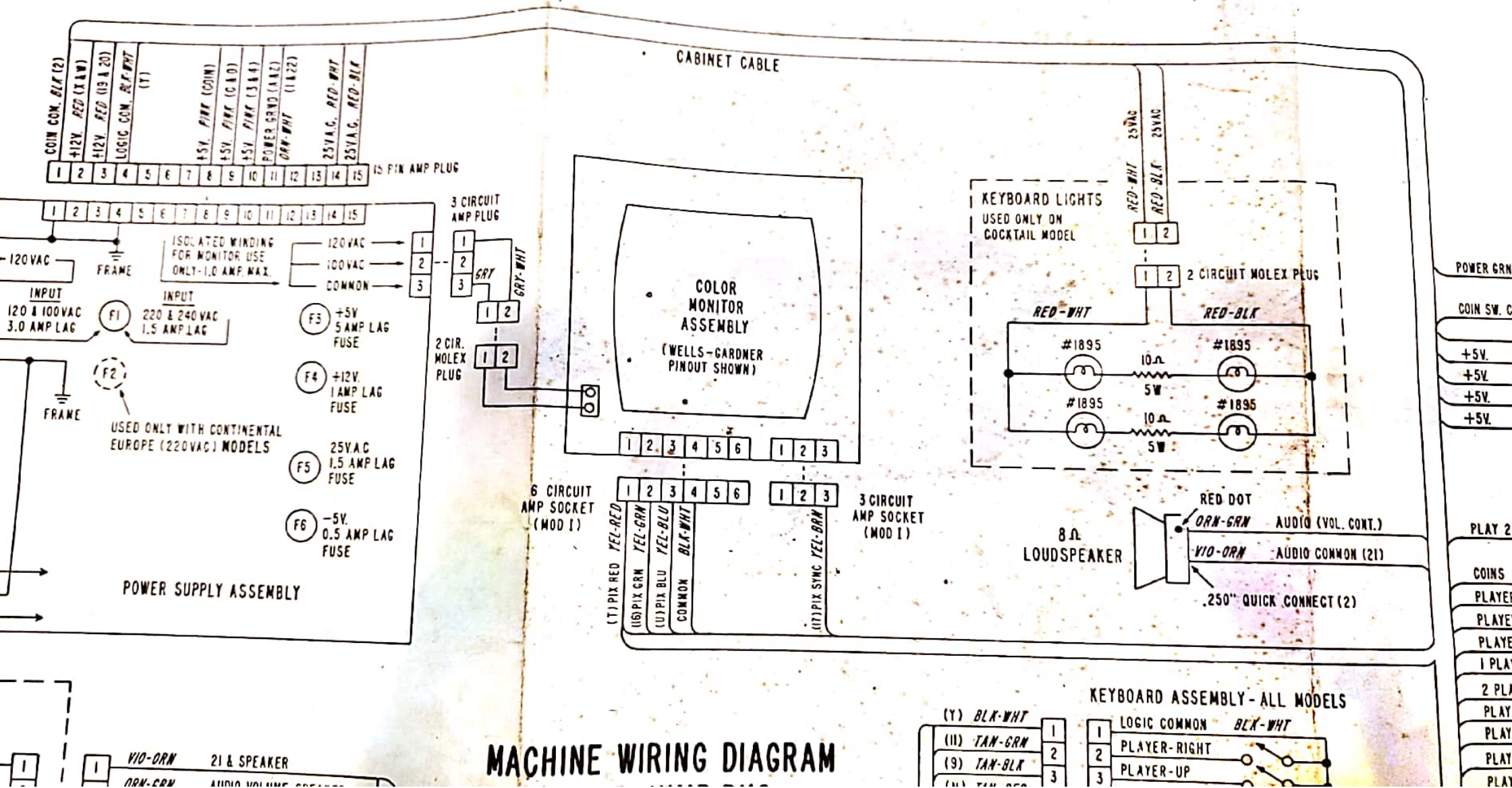

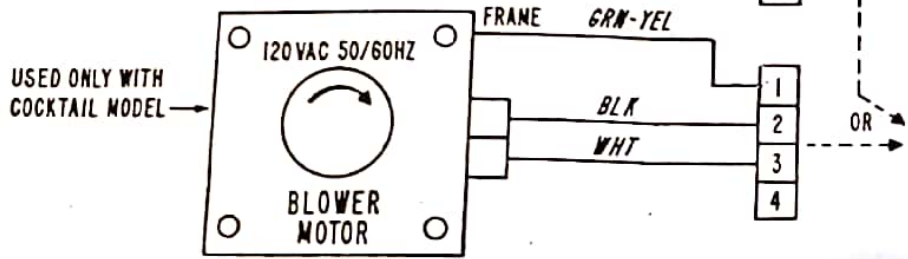
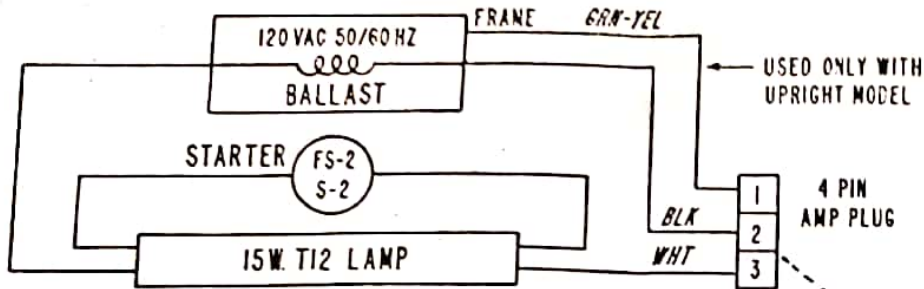

NOTE:
 MAIN POWER SWITCH ASSEMBLY SHOWN IS FOR 120VAC (N. AMERICAN) SERVICE IN UPRIGHT MODEL ONLY. FOR OTHER COUNTRIES & MODELS SEE MANUAL.

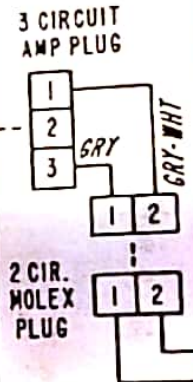
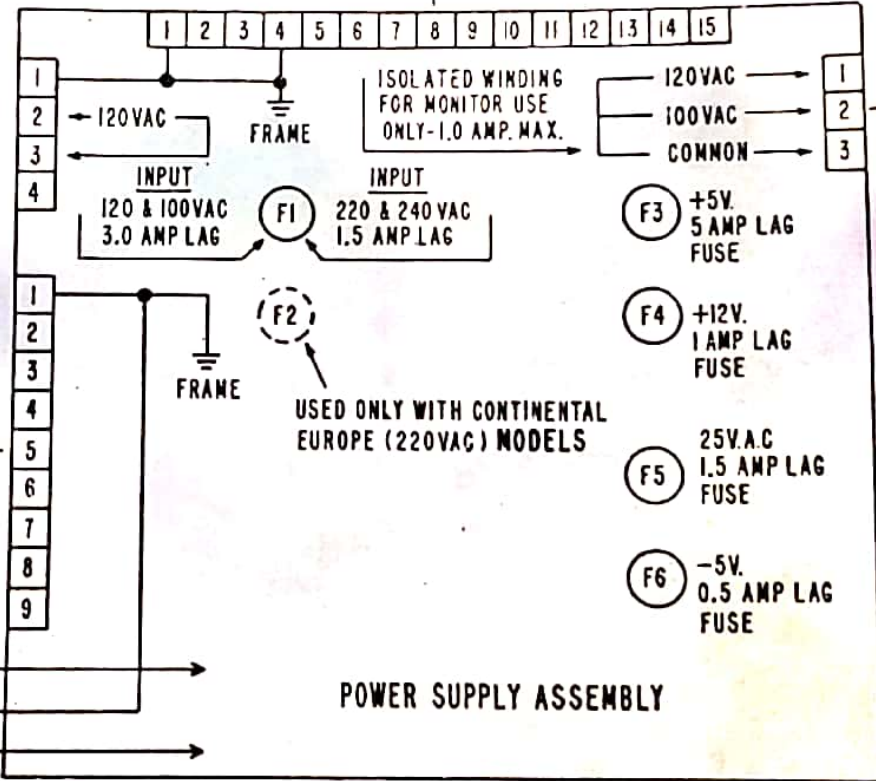
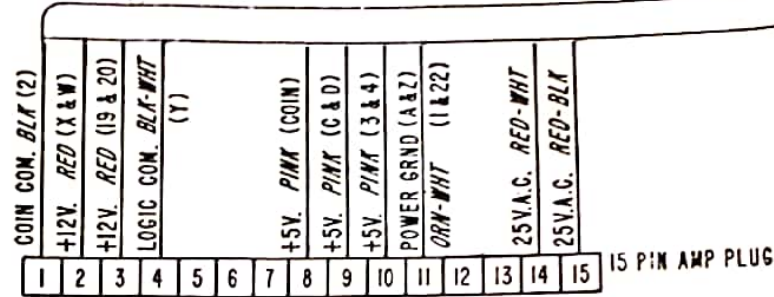
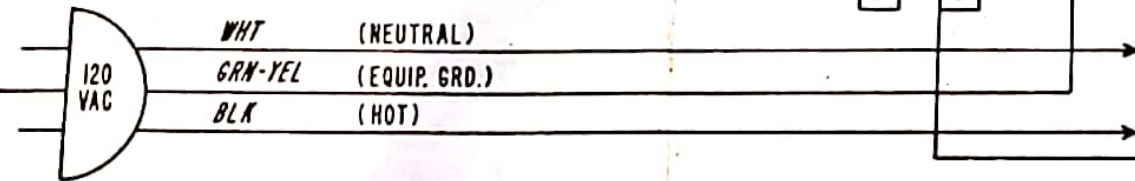
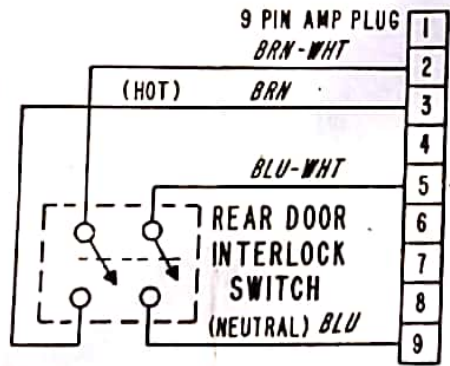

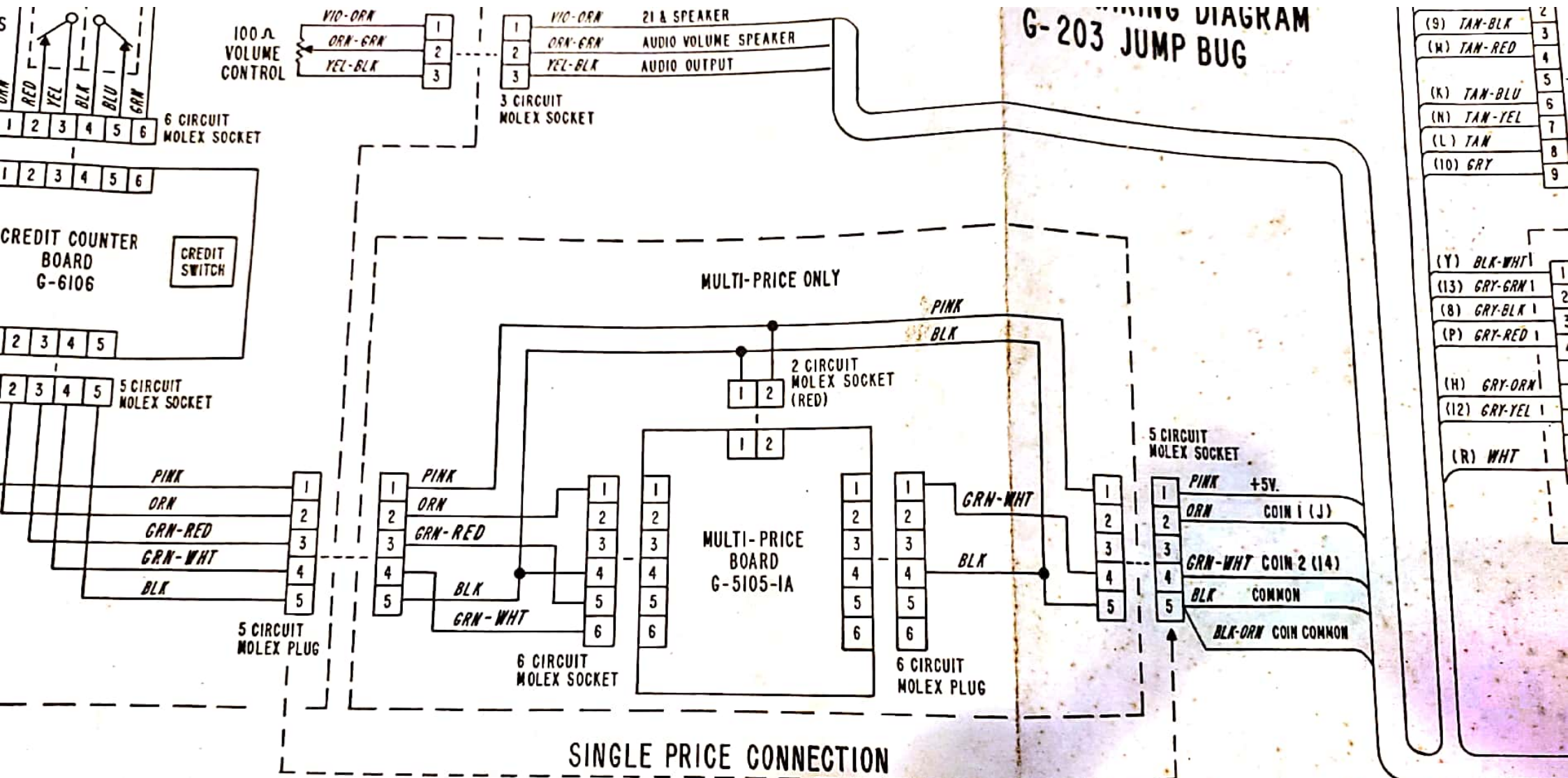

(9) TAN-BLK	2
(W) TAN-RED	3
	4
(K) TAN-BLU	5
(N) TAN-YEL	6
(L) TAN	7
(10) GRY	8
	9

(Y) BLK-WHT	1
(13) GRY-GRN 1	2
(8) GRY-BLK 1	3
(P) GRY-RED 1	4
	5
(H) GRY-ORN	6
(12) GRY-YEL 1	7
	8
(R) WHT	9

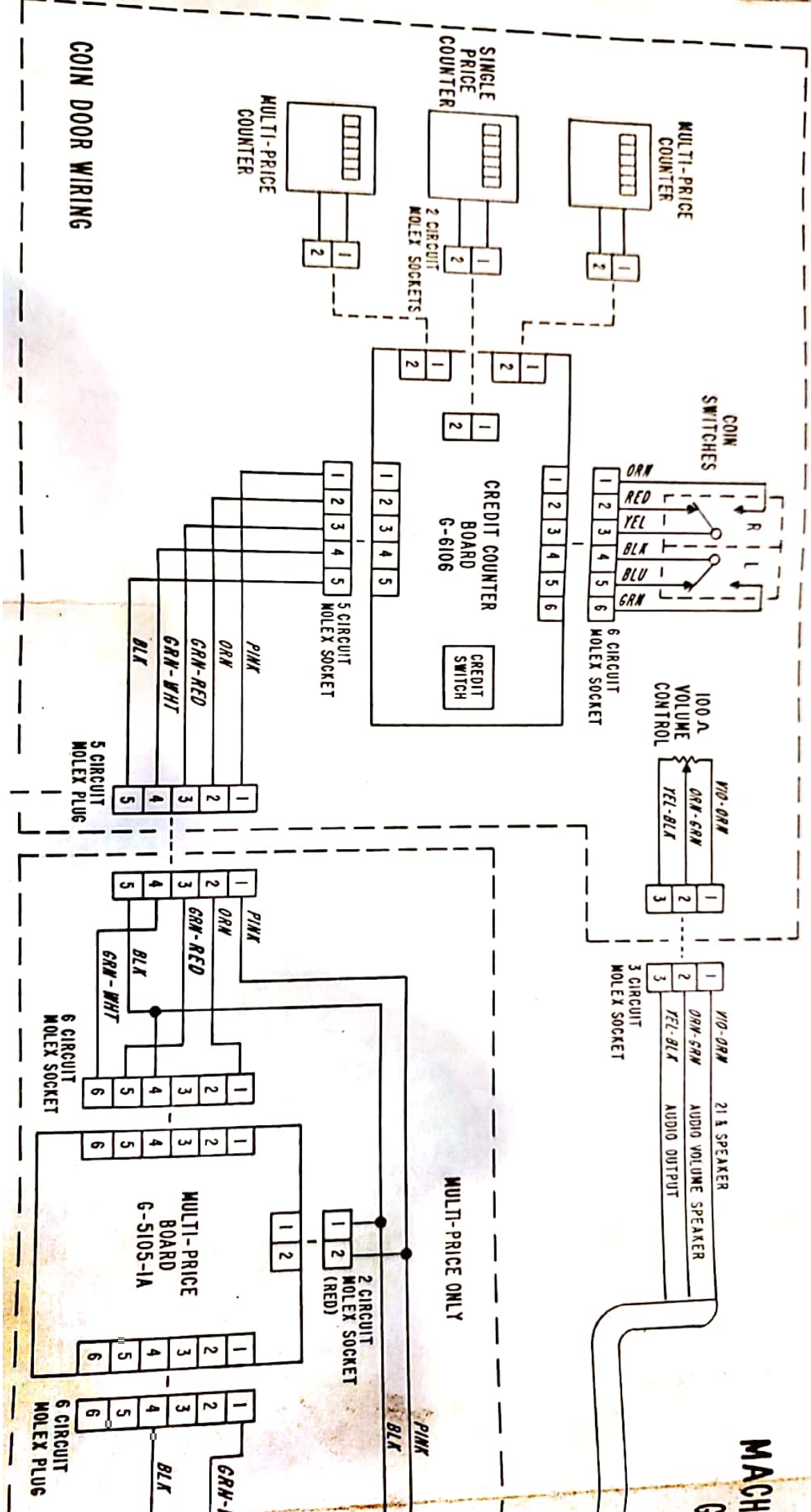

MACH