

ELECTRONIC COMPONENTS & COMPLETE ASSEMBLIES

**FIRST USED ON
“WORLD CUP”**

AND

All Following Solid State Games



Williams[®] ELECTRONICS, INC.
SUBSIDIARY OF XCOR CORPORATION

3401 N. California Ave.
(312) 267-2240

JUNE
1978

Chicago, Ill. 60618, U.S.A.
Cable Address: Wilcoin

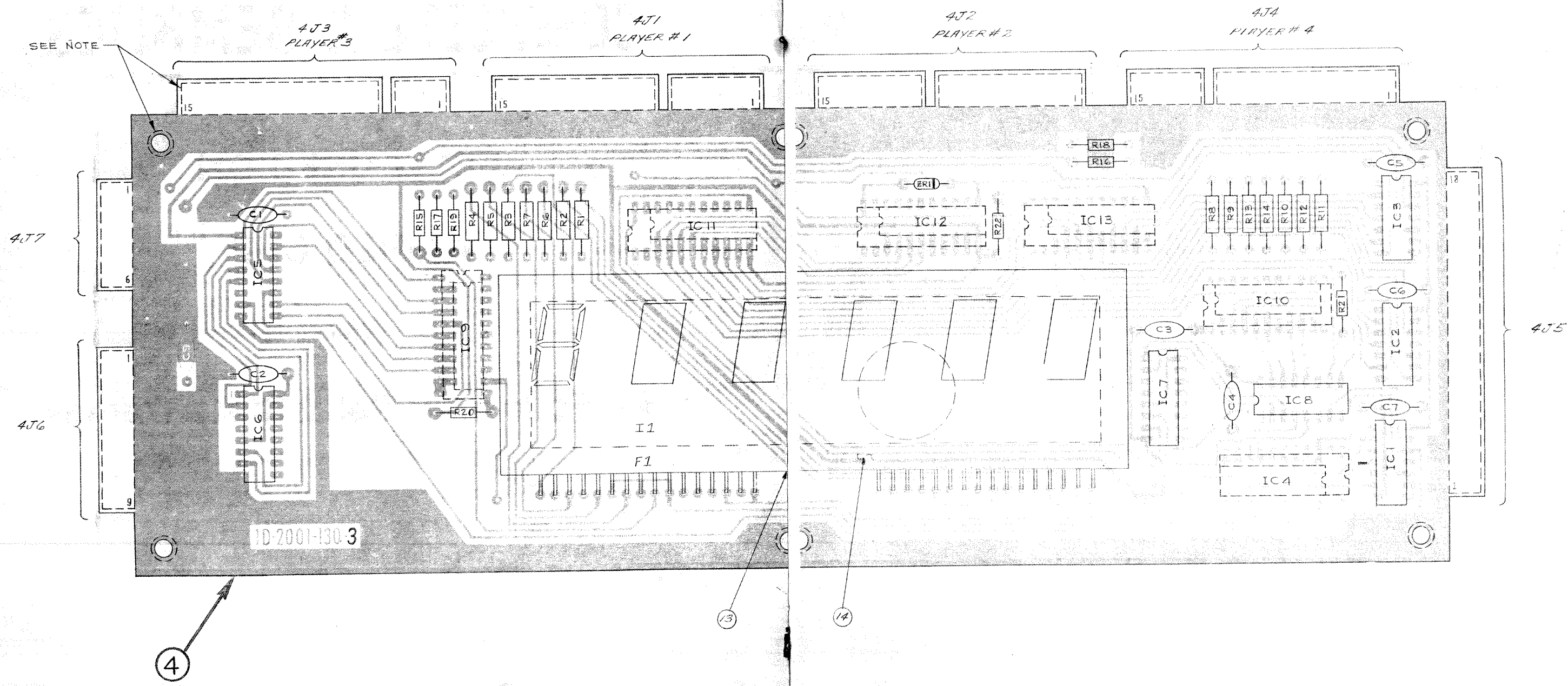

PRICE LIST

ARRANGED BY GROUPS OF RELATED PARTS

<u>DRAWING DESIGNATION</u>	<u>PART NUMBER</u>	<u>DESCRIPTION</u>	<u>PRICE</u>
	D-8000	Master Display Assembly Complete.....	138.00
	1D-2001-130-1	Printed Circuit Board.....	21.00
INTEGRATED CIRCUITS			
IC1,IC2,IC3	5A-8971	MCL14069B MOS Hex Inverter.....	.78
IC4,IC11,IC12,IC13	5A-8968	UDN6184A or NE585 Gas Discharge Display Digit Driver.....	6.60
IC5,IC8	5A-8970	MCL14543B BCD to Seven Segment Decoder.....	2.80
IC9,IC10	5A-8969	UDN7180A or NE584 Gas Discharge Display Segment Driver.....	6.60
DIODES			
ZR1	5A-9118	1N6000 Zener Diode.....	.26
RESISTORS			
R1 THRU R14	5A-8981	10K Ohm 1/2W Carbon Resistor.....	.04
R15 THRU R19	5A-8982	3M Ohm 1/4W Carbon Resistor.....	.04
R20,R21	5A-9119	91K Ohm 1/4W Carbon Resistor.....	.08
R22	5A-9120	270K Ohm 1/4W Carbon Resistor.....	.08
CAPACITORS			
C1 THRU C7	5A-8980	0.01 Mfd. 50V Ceramic Capacitor.....	.22
MISCELLANEOUS			
I1	5A-8966	6 Digit Neon Display Tube.....	27.94
F1	23A-6542	Foam Insulator.....	.42

PRICE LIST

ARRANGED BY GROUPS OF RELATED PARTS

<u>DRAWING DESIGNATION</u>	<u>PART NUMBER</u>	<u>DESCRIPTION</u>	<u>PRICE</u>
	D-7999	Power Supply Assembly Complete.....	138.50
	1D-2001-134	Printed Circuit Board.....	50.00
TRANSISTORS			
Q1	5A-9057	SDS201 NPN Transistor.....	1.08
Q2	5A-9055	MPSD52 PNP Transistor.....	.58
Q3	5A-9058	SDS202 PNP Transistor.....	1.30
Q4	5A-9056	MPSD02 NPN Transistor.....	.48
DIODES			
D3 THRU D6	5A-9054	1N4004 Diode.....	.20
D7,D8	5A-9045	MR501 Diode.....	.40
Z1,Z3	5A-9059	1N5990 Zener Diode.....	.44
Z2,Z4	5A-9060	1N4764 Zener Diode.....	.42
VARISTOR			
VR1	5A-9064	V47ZA7 Varistor for Solenoids.....	1.86
RESISTORS			
R1,R4	5A-9062	39K Ohm 1/2W Carbon Resistor.....	.04
R2,R5	5A-9061	680 Ohm 1/2W Carbon Resistor.....	.04
R3,R6	5A-9069	330K Ohm 1/2W Carbon Resistor.....	.04
CAPACITOR			
C7,C11	5A-9053	100 Mfd. 150V Electrolytic Capacitor.....	2.04
C8,C12,C14,C17	5A-9072	1 Mfd. 500V Ceramic Disc Capacitor.....	1.10
C9,C10	5A-9047	22 Mfd. 400V Mylar Capacitor.....	.70
C13	5A-9070	100 Mfd. 100V Electrolytic Capacitor.....	1.28
C15	5A-9046	12K Mfd. 16V Electrolytic Capacitor.....	4.32
C16	5A-9031	1 Mfd. 25V Tantalum Capacitor.....	.66
MALE CONNECTORS			
J1	5A-9068	Male Connector-12 Pin.....	.82
J2	5A-9067	Male Connector-6 Pin.....	.32
J3	5A-9027	Male Connector-9 Pin.....	.44
J4	5A-9043	Male Connector-12 Pin.....	.64
J5	5A-9038	Male Connector-15 Pin.....	.76
J6	5A-9074	Male Connector-6 Pin.....	.52
FUSES			
F1	5A-8761	1/4 Amp Slo-Blo Fuse.....	1.10
F2	5A-9128	2-1/2 Amp Slo-Blo Fuse.....	.56
F3	5A-9071	8 Amp Regular Fuse.....	.52
F4	5A-9127	20 Amp Fuse (SFE-20 Type).....	.12
F5	5A-6314	4 Amp Slo-Blo Fuse.....	1.10
MISCELLANEOUS			
	5A-9052	Fuse Clip.....	.03
	5A-9041	Heat Sink For 5 Volt Regulator.....	7.92
	5A-9042	Heat Sink for +100,-100 Volt Regulators.....	.22
	5A-9049	3 Amp 5V Voltage Regulator.....	13.20
	3A-7520-1	Nylon Ty-Wrap.....	.08

PRICE LIST

ARRANGED BY GROUPS OF RELATED PARTS

<u>DRAWING DESIGNATION</u>	<u>PART NUMBER</u>	<u>DESCRIPTION</u>	<u>PRICE</u>
	D-7997	Driver Board Assembly Complete.....	355.00
	1B-2001-131	Printed Circuit Board.....	40.00
INTEGRATED CIRCUITS			
IC1 THRU IC4, IC6, IC7, IC13, IC14	5A-8973	7408 Quad And Gate.....	.83
IC5, IC10, IC11	5A-8972	MC6820 Peripheral Interface Adaptor (PIA).....	9.50
IC8, IC9	5A-8948	7402 Quad NOR Gate.....	.84
IC12, IC17, IC18, IC19	5A-8974	7406 Open Collector Hex Inverter.....	1.00
IC15, IC16	5A-8975	MCL4049B MOS Hex Inverter.....	1.18
TRANSISTORS			
Q1, Q3, Q5, Q7, Q9, Q11, Q13, Q14, Q16, Q18, Q20, Q22, Q24, Q26, Q28, Q30, Q32, Q34, Q36, Q38, Q40, Q42, Q44, Q2, Q4, Q6, Q8, Q10, Q12, Q15, Q17, Q19, Q21, Q23, Q25, Q27, Q29, Q31, Q33, Q35, Q37, Q39, Q41, Q43, Q45	5A-3933	2N4401 NPN Transistor.....	.46
Q16, Q18, Q20, Q22, Q24, Q26, Q28, Q30, Q32, Q34, Q36, Q38, Q40, Q42, Q44, Q46, Q48, Q50, Q52, Q54, Q56, Q58, Q60, Q62, Q64, Q66, Q68, Q70, Q72, Q74, Q76	5A-3977	TIP120 NPN Darlington Power Transistor.....	1.56
Q47, Q49, Q51, Q53, Q55, Q57, Q59, Q61	5A-3979	2N6122 NPN Power Transistor.....	1.04
Q63, Q65, Q67, Q69, Q71, Q73, Q75, Q77	5A-3973	TIP42 PNP Power Transistor.....	1.34
RECTIFIERS			
S1 THRU S8	5A-9014	2N5060 Silicon Controlled Rectifier (SCR).....	.54
DIODES			
D1	5A-6253	1N4001 Diode.....	.26
D2 THRU D9	5A-3919	1N4148 Diode.....	.08
RESISTORS			
R1 THRU R6, R27, R77 THRU R92, R157, THRU R195	5A-3991	4.7K Ohm 1/4W Carbon Resistor.....	.04
R7, R10, R13, R16, R19, R22, R29, R32, R35, R38, R41, R44, R47, R50, R53, R56, R59, R62, R65, R68, R71, R74	5A-3992	560 Ohm 1/4W Carbon Resistor.....	.04
R8, R11, R14, R17, R20, R23, R30, R33, R36, R39, R42, R45, R48, R51, R54, R57, R60, R63, R66, R69, R72, R75,	5A-3993	68 Ohm 1/2W Carbon Resistor.....	.04
R9, R12, R15, R18, R21, R24, R25, R31, R34, R37, R40, R43, R46, R49, R52, R55, R58, R61, R64, R67, R70, R73, R76, R26	5A-3997	2.7 Ohm 1/4W Carbon Resistor.....	.04
R28	5A-8817	10K Ohm 1/4W Carbon Resistor.....	.04
R93, R99, R105, R111	5A-3983	3.3K Ohm 1/4W Carbon Resistor.....	.04
R117, R123, R129, R135	5A-9085	1.5K Ohm 1/4W Carbon Resistor.....	.04
R94, R101, R107, R113	5A-9086	6.8K Ohm 1/4W Carbon Resistor.....	.04
R119, R125, R131, R137	5A-9084	100 Ohm 3W Wirewound Resistor.....	.24
R95, R100, R106, R112	5A-8984	1K Ohm 1/4W Carbon Resistor.....	.04
R118, R124, R130, R136			
R96, R97, R102, R103, R108, R109, R114, R115, R120, R121, R126, R127, R132, R133, R138, R139, R196 THRU R211			
RESISTORS			
R98, R104, R110, R116	5A-9037	.4 Ohm 3W Wirewound Resistor.....	.26
R122, R123, R134, R140	5A-3998	2.2K Ohm 1/4W Carbon Resistor.....	.04
R141 THRU R148	5A-3999	27 Ohm 3W Carbon Resistor.....	.22
R149 THRU R156			
CAPACITOR			
C1 THRU C14, C24 THRU C26, C30, C37, C38, C47, C48	5A-8930	0.01 Mfd. 50V Ceramic Capacitor.....	.22
C15	5A-3986	100 Mfd. 10V Electrolytic Capacitor.....	.53
C16 THRU C23	5A-3995	0.1 Mfd. 100V Polyester Film Capacitor.....	.44
C36	5A-3996	0.1 Mfd. 50V Ceramic Capacitor.....	.44
C39 THRU C46	5A-9065	470 Pfd. 50V Ceramic Capacitor.....	.22
C49 THRU C56			
SOCKET FOR IC			
PS1 THRU PS3	5A-3985	40 Pin I.C. Socket.....	1.06
MALE CONNECTOR			
PH1 THRU PH5	5A-9066	Female Receptacle-8 Pin.....	.46
PH1 THRU PH12	5A-9027	Male Connector-9 Pin.....	.44
MISCELLANEOUS			
Z1	5A-3994	Relay-4 Pole 5 Amp Contacts - 6V 40 Ohm Coil....	7.90

X INDICATES KEYING PIN

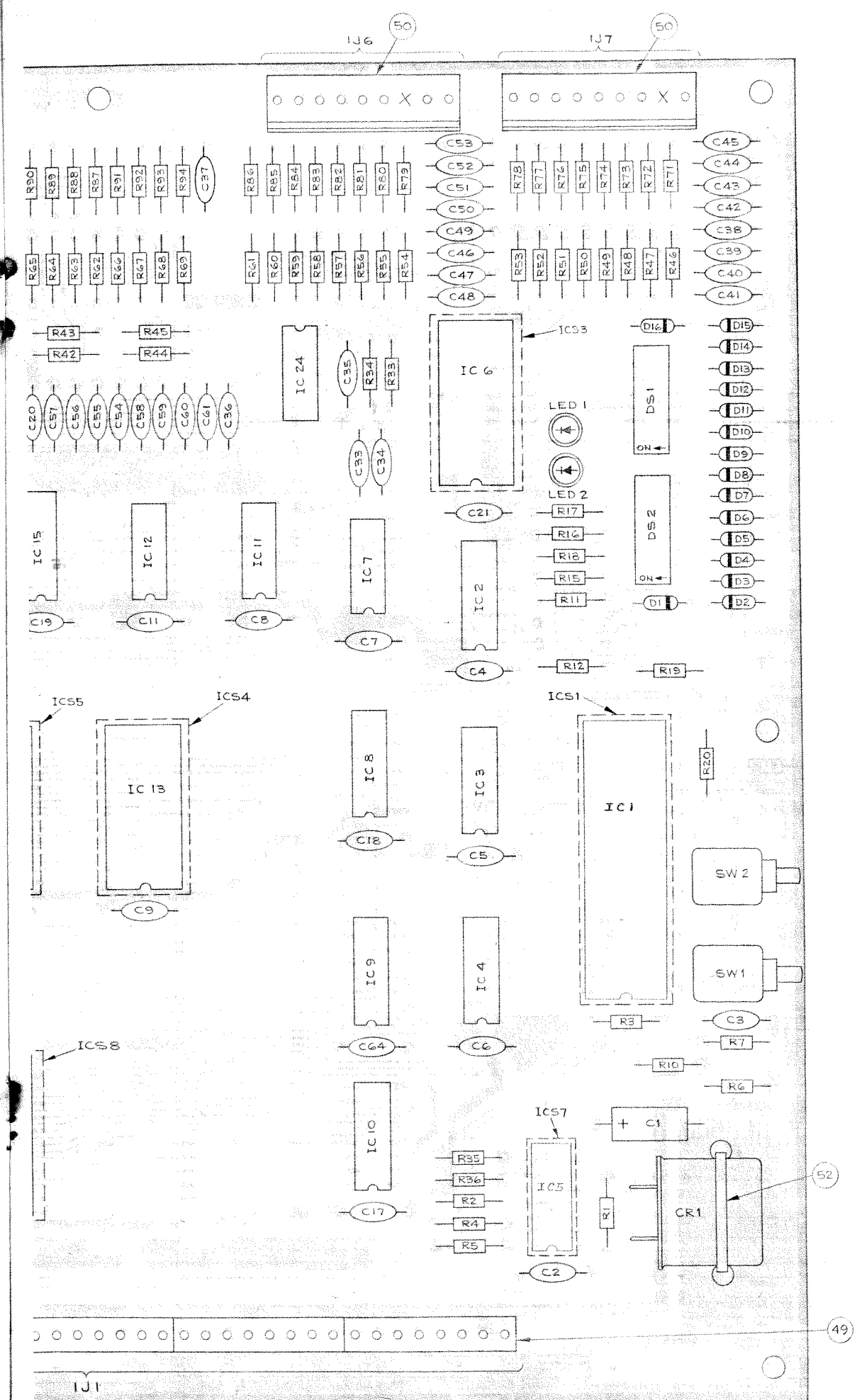
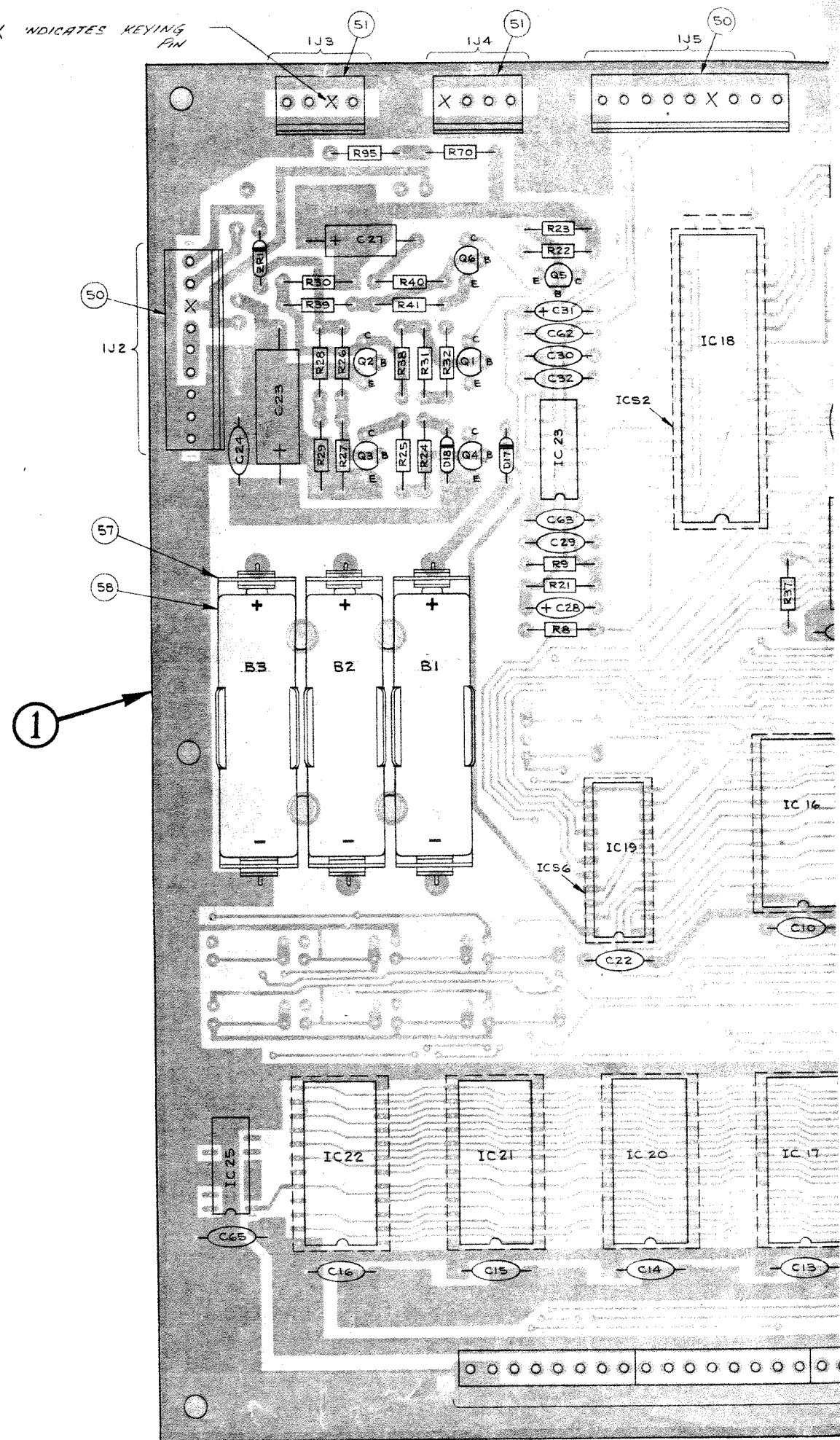

PRICE LIST

ARRANGED BY GROUPS OF RELATED PARTS

<u>DRAWING DESIGNATION</u>	<u>PART NUMBER</u>	<u>DESCRIPTION</u>	<u>PRICE</u>
	D-7998	C.P.U. Assembly Complete.....	355.00
	1B-2001-133-1	Printed Circuit Board.....	51.90
INTEGRATED CIRCUITS			
IC1	5A-8987	MC6800 Microprocessor Unit (MPU).....	18.50
IC2, IC9, IC10	5A-8990	8T28 Quad Buffer/Receiver.....	3.50
IC3, IC4, IC8	5A-8989	8T97 Hex Buffer.....	2.32
IC5	5A-8988	MC6875 Clock Chip.....	7.26
IC6	5A-9010	7415 4 to 16 Decoder.....	2.32
IC7	5A-9013	7404 Hex Inverter.....	.36
IC11	5A-9011	7410 3 Input NAND Gate.....	.76
IC12	5A-8973	7408 Quad AND Gate.....	.89
IC13, IC16	5A-9003	MC6810 256x8 RAM.....	7.04
IC15	5A-9012	7442 4 to 10 Decoder.....	1.32
IC17	5A-9008	69316 2Kx8 ROM (Upper Background).....	16.40
IC18	5A-8972	MC6820 Peripheral Interface Adaptor (PIA).....	9.50
IC19	5A-9017	5101 256x4 CMOS RAM.....	17.50
IC20	5A-9007	69316 2Kx8 ROM (Lower Background).....	16.40
IC21, IC22	5A-9015	7641 512x8 PROM (Specify Game and Revision - Hot Tip J1, J2, L1, L2 or Lucky Seven A1, A2 etc).....	15.34
IC23	5A-9002	MC3456 556 Dual Timer.....	1.76
IC24	5A-9073	7400 Quad 2 Input NAND Gate.....	.84
IC25	5A-8948	7402 Quad NOR Gate.....	.84
TRANSISTORS			
Q1, Q2, Q3, Q6	5A-8939	2N4401 NPN Transistor.....	.46
Q4, Q5	5A-9016	2N4403 PNP Transistor.....	.36
DIODES			
D1 THRU D18	5A-8919	1N4148 Diode.....	.08
ZR1	5A-9018	1R5996 Zener Diode.....	.34
RESISTORS			
R1, R20, R24, R26, R28, R30, R38, R40, R71, R95	5A-3904	1K Ohm 1/4W Carbon Resistor.....	.04
R2	5A-9035	47K Ohm 1/4W Carbon Resistor.....	.04
R3, R4, R5	5A-9040	33 Ohm 1/4W Carbon Resistor.....	.04
R6, R8, R10, R23	5A-3983	3.3 Ohm 1/4W Carbon Resistor.....	.04
R9	5A-9032	12K Ohm 1/4W Carbon Resistor.....	.04
R11, R12	5A-9036	100 Ohm 1/4W Carbon Resistor.....	.04
R15, R19, R33, R36	5A-3991	4.7K Ohm 1/4W Carbon Resistor.....	.04
R42, R43, R46, R70			
R21	5A-9117	1.3K Ohm 1/4W Carbon Resistor.....	.10
R22	5A-9113	33K Ohm 1/4W Carbon Resistor.....	.04
R27, R29, R31, R41	5A-9034	10K Ohm 1/4W Carbon Resistor.....	.04
R32, R37	5A-9039	10 Ohm 1/4W Carbon Resistor.....	.04
R44, R45	5A-9083	470 Ohm 1/4W Carbon Resistor.....	.04
CAPACITOR			
C1	5A-9009	22 Mfd. 10V Tantalum Capacitor.....	.74
C2, C11, C13, C22, C29	5A-3930	0.01 Mfd. 50V Ceramic Capacitor.....	.22
C30, C33, C37, C63, C65			
C23	5A-3986	100 Mfd. 10V Electrolytic Capacitor.....	.53
C24	5A-8996	0.1 Mfd. 50V Ceramic Capacitor.....	.44
C27	5A-9023	3.3 Mfd. 10V Tantalum Capacitor.....	.66
C28	5A-9029	0.1 Mfd. 10V Tantalum Capacitor.....	.66
C31	5A-9031	1 Mfd. 25V Tantalum Capacitor.....	.66
C32	5A-9030	0.047 Mfd. 50V Ceramic Capacitor.....	.30
C38 THRU C62	5A-9065	470K Pfd. 50V Ceramic Capacitor.....	.22
C66	5A-9137	120 Pfd. 100V Ceramic Capacitor.....	3.43
SOCKET FOR IC			
ICS1, ICS2	5A-8985	40 Pin I.C. Socket.....	1.06
ICS3, ICS4, ICS5, ICS8	5A-9004	24 Pin I.C. Socket.....	.58
ICS6	5A-9005	22 Pin I.C. Socket.....	.72
ICS7	5A-9006	16 Pin I.C. Socket.....	.42
MALE CONNECTORS			
	5A-9028	4 Pin Male Connector.....	.22
	5A-9026	3 Pin Male Connector.....	.32
	5A-9027	9 Pin Male Connector.....	.44
MISCELLANEOUS			
DS1, DS2	5A-9025	8BTN Dip Switch.....	3.00
LED1, LED2	5A-9019	Red Light Emitting Diode (LED).....	.32
SW1, SW2	5A-9024	SPDT Momentary Switch.....	4.00
CR1	5A-9020	3.58 MHz. Color Burst Crystal.....	2.34
	3A-7520	Nylon Ty-wrap.....	.04
	3A-7520-1	Nylon Ty-wrap.....	.08
B1, B2, B3	5A-9022	Alkaline Battery (1.5 Volts).....	1.02
	5A-9021	Holder For Battery-2171.....	2.64
L1	5A-9136	15 Microhenry Inductor.....	1.89

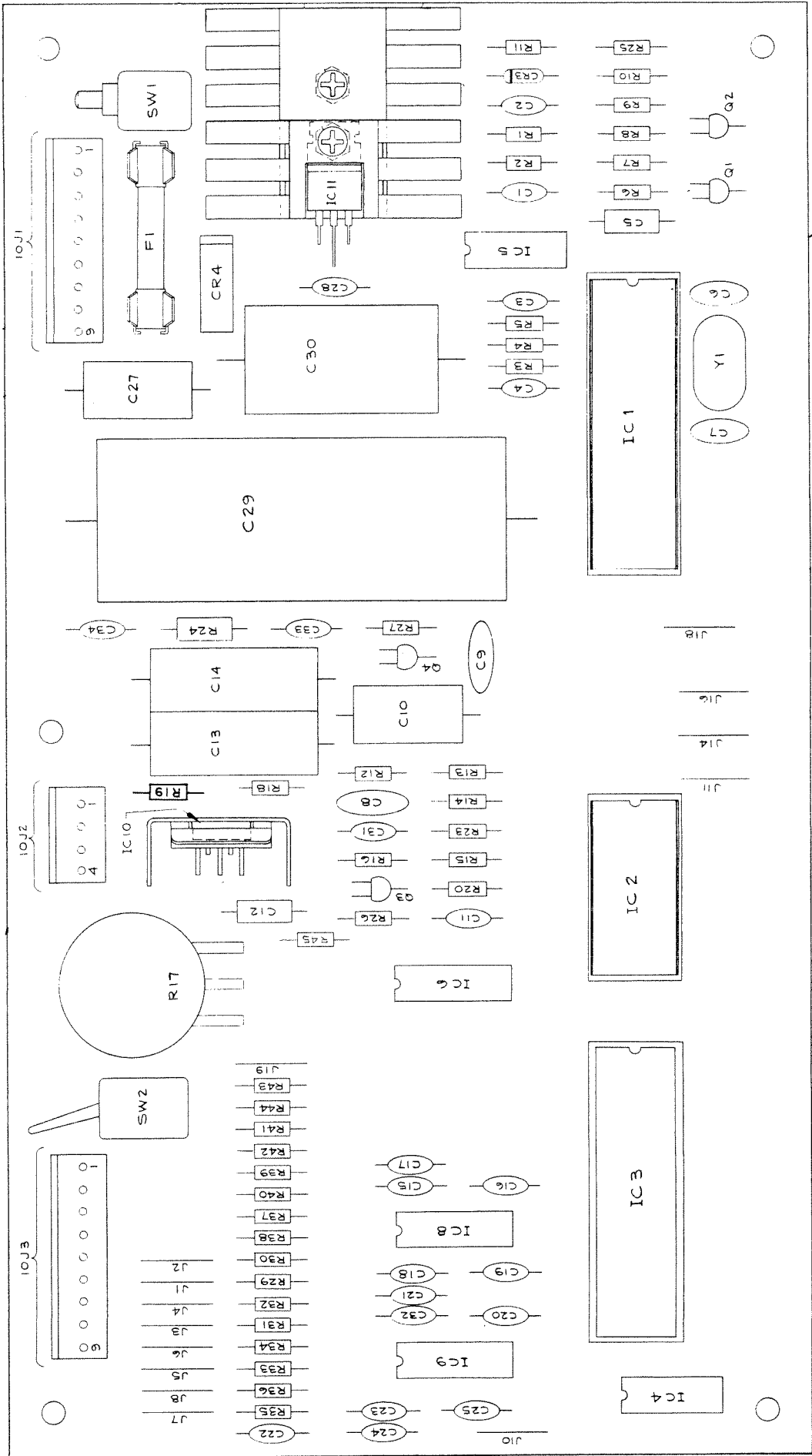

10

PRICE LIST

ARRANGED BY GROUPS OF RELATED PARTS

<u>DRAWING DESIGNATION</u>	<u>PART NUMBER</u>	<u>DESCRIPTION</u>	<u>PRICE</u>
	D-8066	Sound Board Assembly Complete.....	153.00
	1B-2001-137	Printed Circuit Board.....	21.78
INTEGRATED CIRCUITS			
IC1	5A-9150	MC6802 Microprocessor Unit (MPU).....	31.90
IC2	5A-9015	7641 512x8 PROM (Specify Name of Game & Number)..	15.84
IC3	5A-8972	MC6820 Peripheral Interface Adaptor (PIA).....	9.50
IC4	5A-9154	4068 8 Input NAND Gate.....	.74
IC5	5A-9155	4011 Quad 2 Input NAND Gate.....	.74
IC6	5A-9152	MCL408 D/A Converter.....	3.86
IC8, IC9	5A-9153	4050 Hex Buffer.....	1.14
IC10	5A-9156	TDA2002V Audio Amplifier.....	3.29
IC11	5A-9157	1 Amp 5V 7805 Voltage Regulator.....	3.16
TRANSISTORS			
Q1, Q2, Q3	5C-8938	2N1401 NPN Transistor.....	.46
Q4	5A-8976	2N6427 NPN Darlington Transistor.....	.58
RECTIFIERS			
CR4	5A-9158	MDA200/3N253 Bridge Rectifier.....	1.49
DIODES			
CR3	5A-9018	1N5996 Zener Diode.....	.34
RESISTORS			
R1, R2, R37 THRU R45	5B-8991	4.7K Ohm 1/4W Carbon Resistor.....	.04
R3, R4, R5, R15, R16, R20	5B-8983	3.3K Ohm 1/4W Carbon Resistor.....	.04
R6, R12, R13	5B-9035	47K Ohm 1/4W Carbon Resistor.....	.04
R7	5B-9039	10 Ohm 1/4W Carbon Resistor.....	.04
R8, R11	5B-8817	10K Ohm 1/4W Carbon Resistor.....	.04
R9, R10, R25, R27	5A-8984	1K Ohm 1/4W Carbon Resistor.....	.04
R14, R23	5A-9162	100K Ohm 1/4W Carbon Resistor.....	.05
R17	5A-9170	5K Ohm 2W Log Taper Potentiometer.....	4.84
R18	5A-9160	220 Ohm 1/4W Carbon Resistor.....	.05
R19	5A-9161	2.2 Ohm 1/4W Carbon Resistor.....	.05
R24	5A-9181	1 Ohm 1/2W Carbon Resistor.....	.13
R26	5A-9179	3.3 Meg Ohm 1/4W Carbon Resistor.....	.05
R29 THRU R36	5B-9036	100 Ohm 1/4W Carbon Resistor.....	.04
CAPACITORS			
C1 THRU C4, C15, C24,	5A-8980	0.01 Mfd 50V Ceramic Capacitor.....	.22
C25, C32	5A-9163	2.2 Mfd 15V Tantalum Capacitor.....	.92
C5	5A-9169	27Pfd 1000V Ceramic Capacitor.....	.22
C6, C7	5A-9167	.003 Mfd 1000V Ceramic Capacitor.....	.25
C8	5A-9166	.0015 Mfd 1000V Ceramic Capacitor.....	.24
C9	5A-9168	25 Mfd 20V Electrolytic Capacitor.....	.53
C10	OR		
	5A-9168-1	33 Mfd 16V Electrolytic Capacitor.....	.53
C11	5A-9180	47 Pfd 1000V Ceramic Capacitor.....	.22
C12	5A-9031	1 Mfd 25V Tantalum Capacitor.....	.66
C13	5A-9164	500 Mfd 15V Electrolytic Capacitor.....	1.45
	OR		
	5A-9164-1	470 Mfd 25V Electrolytic Capacitor.....	1.45
C14	5A-9165	800 Mfd 16V Electrolytic Capacitor.....	1.76
	OR		
	5A-9165-1	1000 Mfd 15V Electrolytic Capacitor.....	1.76
C16 THRU C23	5A-9065	470 Pfd 50V Ceramic Capacitor.....	.22
C27	5A-8986	100 Mfd 10V Electrolytic Capacitor.....	.58
C28, C31, C33, C34	5A-8996	0.1 Mfd 50V Ceramic Capacitor.....	.44
C29	5A-9046	12K Mfd 16V Electrolytic Capacitor.....	4.32
C30	5A-8893	1000 Mfd 25V Electrolytic Capacitor.....	2.20
SOCKET FOR IC			
	5A-9004	24 Pin I.C. Socket.....	.58
	5A-8985	40 Pin I.C. Socket.....	1.06
MALE CONNECTORS			
10J1, 10J3	5A-9027	9 Pin Male Connector.....	.44
10J2	5A-9028	4 Pin Male Connector.....	.22
MISCELLANEOUS			
	5A-9178	Fuse Clip.....	.13
F1	5A-6314	4 Amp Slo-Blo Fuse.....	1.10
	5A-9172	Heat Sink for 5V Regulator (Large).....	.57
	5A-9173	Heat Sink for 5V Regulator (Small).....	.40
	5A-9174	Heat Sink for Audio Amplifier.....	.57
Y1	5A-9020	3.58 Mhz Color Burst Crystal.....	4.00
SW1	5A-9024	SPDT Momentary Switch.....	4.00
SW2	5A-9171	SPDT Toggle Switch.....	3.61

C-8019

SLAVE DISPLAY ASSEMBLY

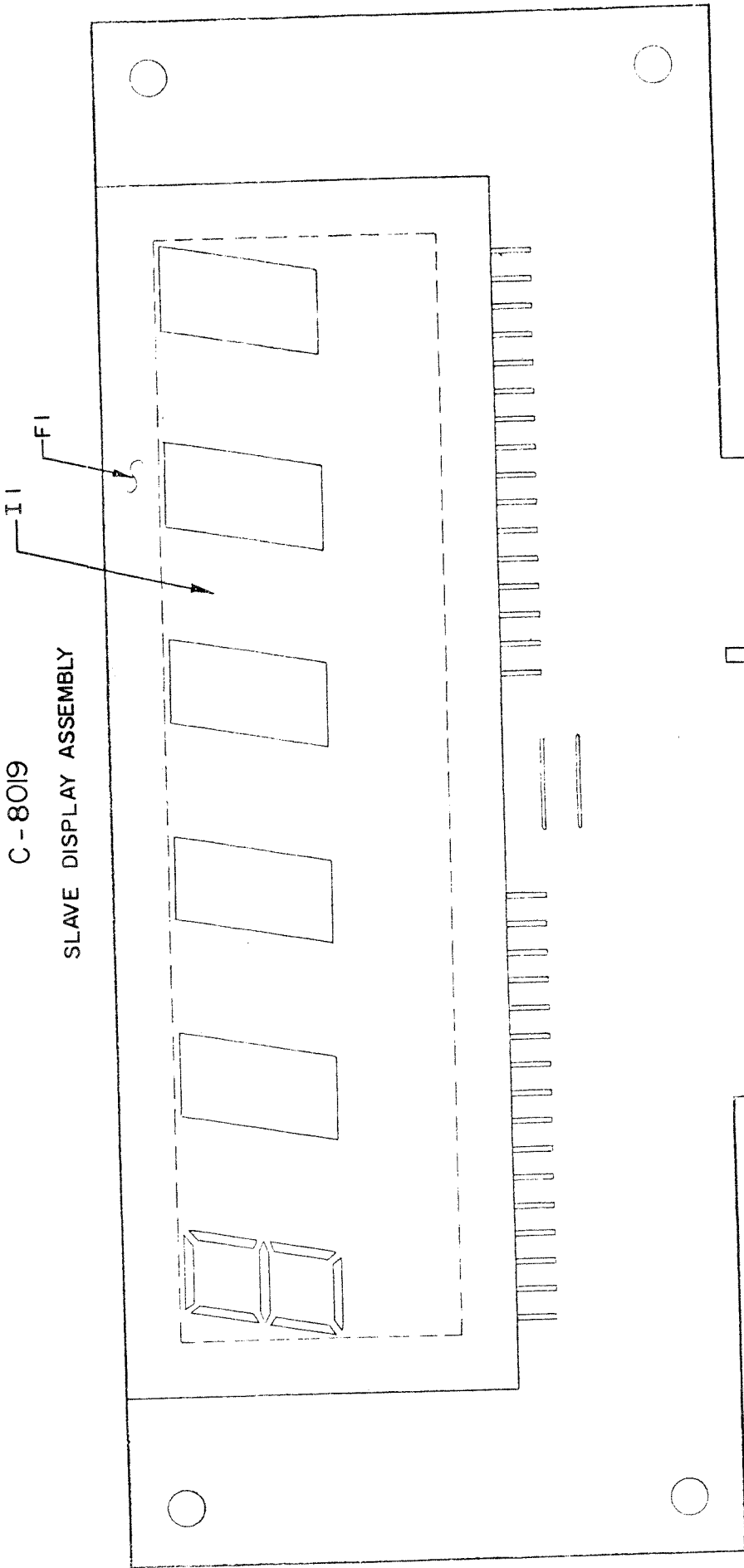

PRICE LIST

ARRANGED BY GROUPS OF RELATED PARTS

<u>DRAWING DESIGNATION</u>	<u>PART NUMBER</u>	<u>DESCRIPTION</u>	<u>PRICE</u>
	C-8019	Slave Display Assembly Complete.....	51.50
	1D-2001-132	Printed Circuit Board.....	5.80
<u>MISCELLANEOUS</u>			
I1	5A-8966	6 Digit Neon Display Tube.....	27.90
F1	23A-6542	Foam Insulator.....	.42

5A-9051

ELECTROLYTIC CAPACITOR

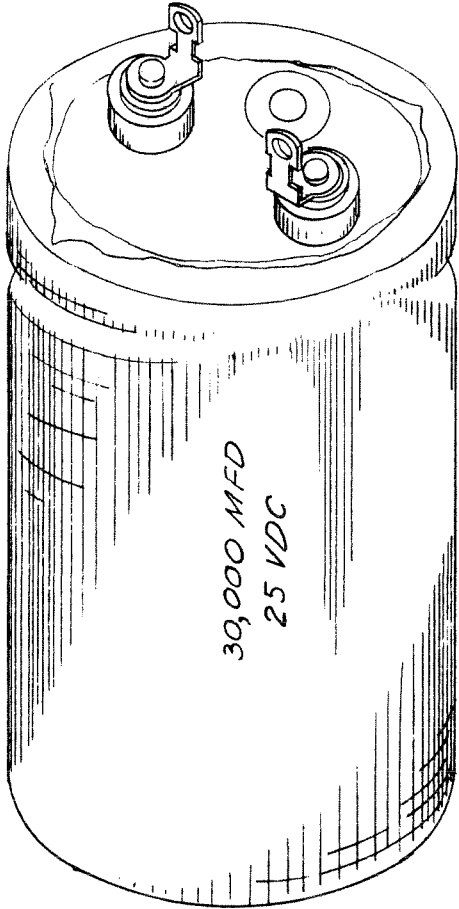

5A-9050

BRIDGE RECTIFIER

(ONE FOR LAMPS - ONE FOR SOLENOIDS)

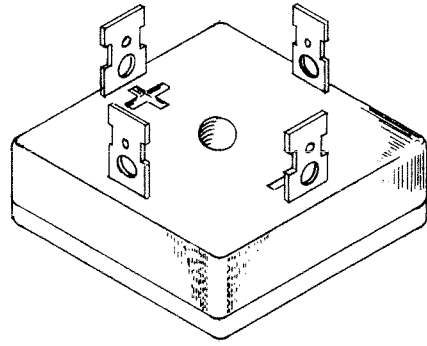

20A-9213

METAL CLAMP

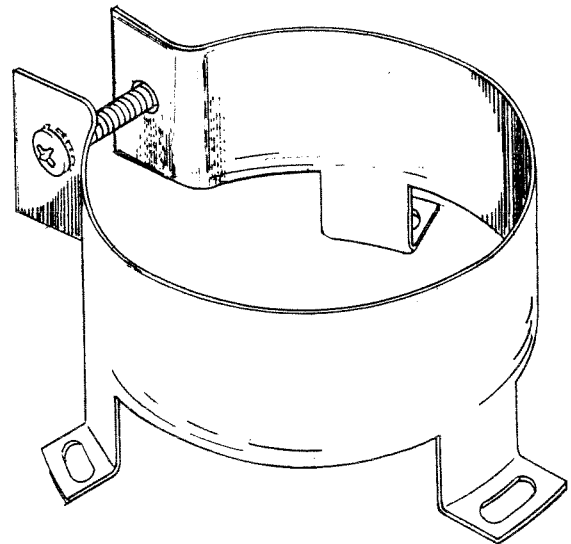

PRICE LIST

ARRANGED IN NUMERICAL ORDER

<u>PART NUMBER</u>	<u>DESCRIPTION</u>	<u>PRICE</u>
5A-9050	MDA-3501-35A Bridge Rectifier.....	6.16
5A-9051	Electrolytic Capacitor-30,000 MFD 25 VDC.....	11.36
20A-9213	Metal Clamp for Capacitor.....	.98

MALE AND FEMALE CONNECTORS



MALE
1 PIN



FEMALE
1 PIN

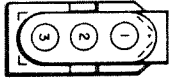
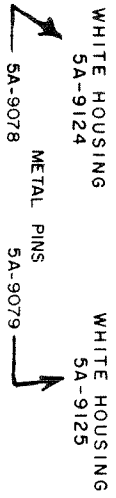

MALE
3 PIN

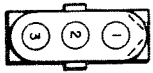

FEMALE
3 PIN

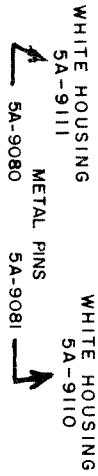

FEMALE

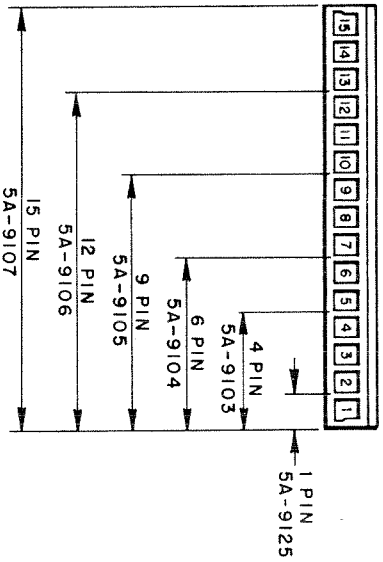

FEMALE
12 PIN

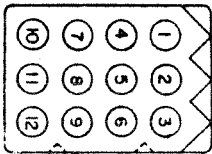

WHITE HOUSING
5A-9109

METAL PIN 5A-9080 (I)

METAL PIN 5A-9081 (8)

FEMALE
6 PIN

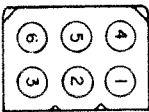

WHITE HOUSING
5A-9108

METAL PIN 5A-9080 (I)

METAL PIN 5A-9081 (I)

FEMALE

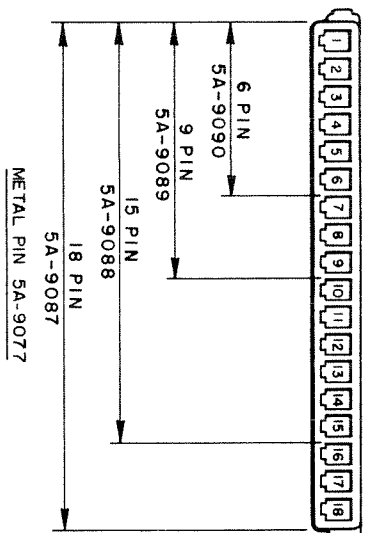

MALE
9 PIN

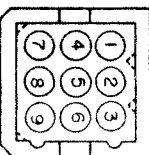

WHITE HOUSING
5A-9138

METAL PINS
5A-9078

5A-9079

WHITE HOUSING
5A-9139

FEMALE
9 PIN

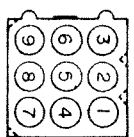

WHITE HOUSING
5A-9132

METAL PINS
5A-9078

5A-9079

MALE
24 PIN

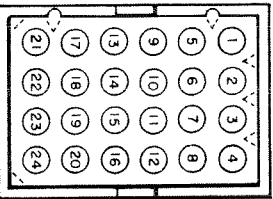

WHITE HOUSING
5A-9097

BLACK HOUSING
5A-9099

METAL PINS
5A-9078

5A-9079

FEMALE
24 PIN

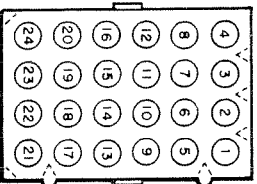

WHITE HOUSING
5A-9098

BLACK HOUSING
5A-9100

METAL PINS
5A-9079

MALE
15 PIN

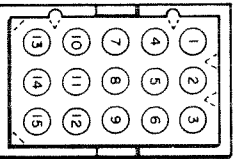

WHITE HOUSING
5A-9093

BLACK HOUSING
5A-9095

METAL PINS
5A-9078

5A-9079

FEMALE
15 PIN



WHITE HOUSING
5A-9094

BLACK HOUSING
5A-9096

METAL PINS
5A-9079

MALE
12 PIN

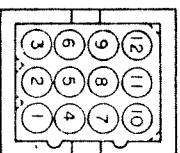

WHITE HOUSING
5A-9132

METAL PINS
5A-9078

5A-9079

FEMALE
12 PIN

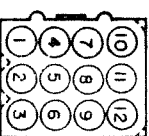

WHITE HOUSING
5A-9133

METAL PINS
5A-9079

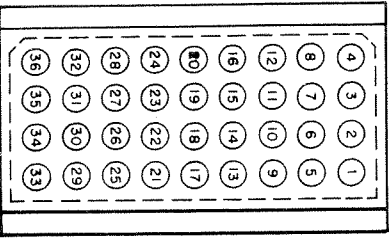

MALE
36 PIN

WHITE HOUSING
5A-9101

METAL PINS
5A-9078

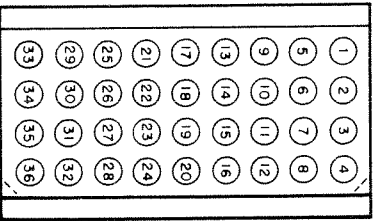

FEMALE
36 PIN

WHITE HOUSING
5A-9102

METAL PINS
5A-9079

PRICE LIST

ARRANGED BY SIZE OF CONNECTOR

<u>PART NUMBER</u>	<u>DESCRIPTION</u>	<u>PRICE</u>
5A-9125	1 Pin-Female Receptacle.....	.08
5A-9110	3 Pin-Female Receptacle.....	.16
5A-9103	4 Pin-Female Receptacle.....	.18
5A-9090	6 Pin-Edge Connector.....	.40
5A-9108	6 Pin-Female Receptacle.....	.26
5A-9104	6 Pin-Female Receptacle.....	.20
5A-9089	9 Pin-Edge Connector.....	.42
5A-9105	9 Pin-Female Receptacle.....	.22
5A-9139	9 Pin-Female Receptacle.....	.41
5A-9106	12 Pin-Female Receptacle.....	.46
5A-9109	12 Pin-Female Receptacle.....	.32
5A-9133	12 Pin-Female Receptacle.....	.32
5A-9107	15 Pin-Female Receptacle.....	.50
5A-9096	15 Pin-Black Female Receptacle.....	.52
5A-9094	15 Pin-Female Receptacle.....	.50
5A-9088	15 Pin-Edge Connector.....	.46
5A-9087	18 Pin Edge Connector.....	.46
5A-9098	24 Pin-Female Receptacle.....	.58
5A-9100	24 Pin-Female Receptacle.....	.62
5A-9102	36 Pin-Female Receptacle.....	.64
5A-9076	Terminal Crimp.....	.03
5A-9077	Terminal Crimp.....	.04
5A-9079	Terminal Pin-Female.....	.03
5A-9081	Terminal Pin-Female.....	.04
5A-9124	1 Pin-Male Connector.....	.08
5A-9111	3 Pin-Male Connector.....	.14
5A-9138	9 Pin-Male Connector.....	.36
5A-9132	12 Pin-Male Connector.....	.37
5A-9093	15 Pin-Male Connector.....	.36
5A-9095	15 Pin-Black Male Connector.....	.40
5A-9097	24 Pin-Male Connector.....	.56
5A-9099	24 Pin-Black Male Connector.....	.60
5A-9101	36 Pin-Male Connector.....	.62
5A-9078	Terminal Pin-Male.....	.03
5A-9080	Terminal Pin-Male.....	.04
5A-9082	Polarizing Key.....	.06
5A-9116	Polarizing Key.....	.08

PRICE LIST

ARRANGED IN NUMERICAL ORDER

<u>PART NUMBER</u>	<u>DESCRIPTION</u>	<u>PRICE</u>
1A-3444	Mounting Bracket for Plumb Bob Tilt.....	.24
1A-3445	Tilt Bracket for Carbon Plumb Bob.....	.36
1A-6734	Mounting Bracket for Sound Board.....	1.72
5A-6205	Surface Mounted Outlet - Single.....	1.00
5B-6258	1N4001 Diode.....	.26
5A-6314	4 Amp Slo-Blo Fuse.....	1.10
5A-8895	Line Filter.....	16.20
5A-9044	115V Line Varistor.....	2.50
5A-9063	230V Line Varistor.....	2.10
5A-9121	4 Amp Regular Fuse.....	.50
5A-9122	7-1/2 Amp Regular Fuse.....	.36
11D-517	Wood Mechanism Panel.....	5.50
12A-6231	Wireform for Plumb Bob Tilt.....	.12
20A-6502-A	Carbon Plumb Bob.....	1.14
B-6448-1	Fuse Clip Assembly (Single).....	.83
B-6572	Ball Roll Tilt Assembly Complete.....	4.80
B-8047	Knocker Assembly Complete.....	5.92
C-8066	Sound Board Assembly Complete.....	153.00

D-7078
 FRONT DOOR ASSEMBLY
 (TOP VIEW)

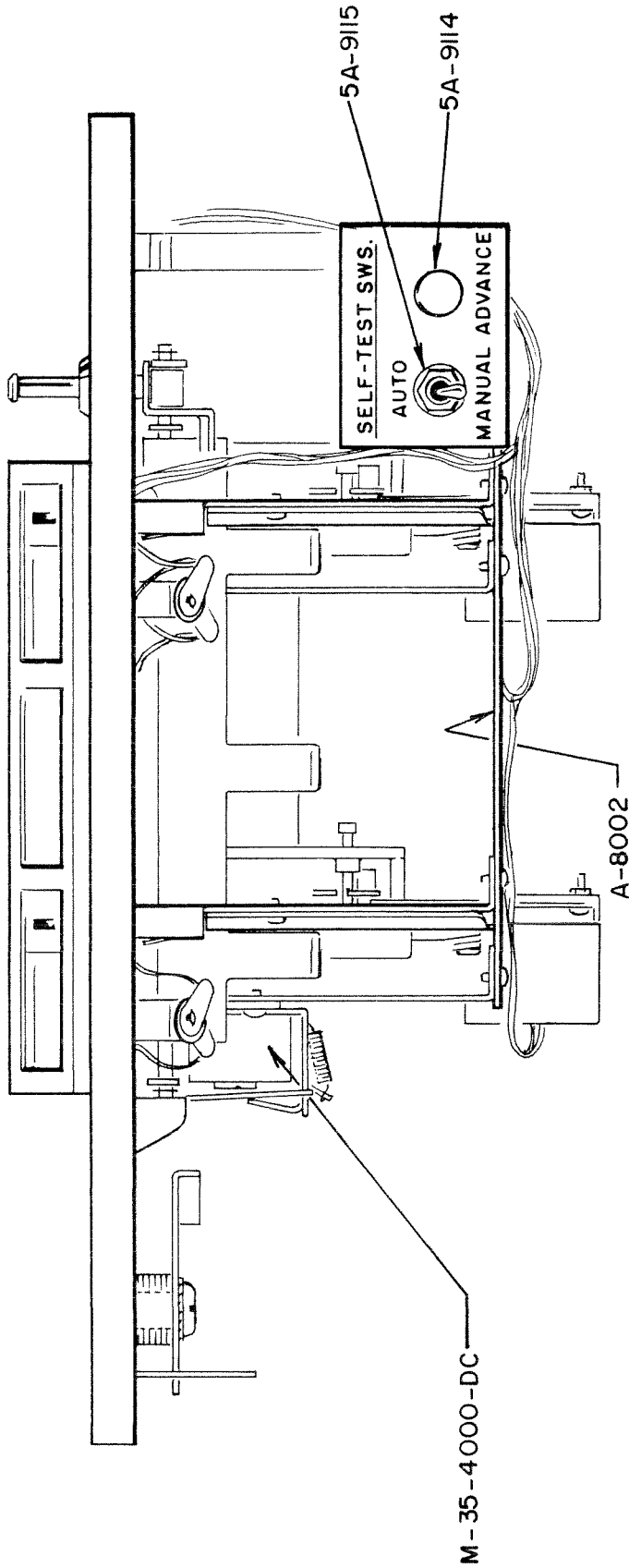

PRICE LIST

ARRANGED IN NUMERICAL ORDER

<u>PART NUMBER</u>	<u>DESCRIPTION</u>	<u>PRICE</u>
5A-9114	Momentary Switch (Push Button Type).....	7.20
5A-9115	ST1-1 Toggle Switch.....	4.84
A-8002	Mounting Bracket Assembly for Switches.....	1.44
M-35-4000-DC	Coil Assembly for Front Door.....	2.50

ELECTRONIC COMPONENTS EXTRA PARTS KIT

(CAN BE ORDERED AS A COMPLETE KIT OR INDIVIDUALLY)

QUANTITY	PART NUMBER	DESCRIPTION	USED ON	PRICE
	B-8068	EXTRA PARTS KIT COMPLETE.....		\$189.06 ea.
6	5A-8938	2N4401 NPN Transistor.....	DRIVER	.46 ea.
1	5A-8948	7402 Quad NOR Gate.....	DRIVER	.84
1	5A-8968	UDN6184A Digit Driver.....	MASTER DISPLAY	6.60
1	5A-8968-1	DI-512 Digit Driver.....	MASTER DISPLAY	6.60
2	5A-8969	UDN7180A Segment Driver.....	MASTER DISPLAY	6.60 ea.
1	5A-8970	MC14543B BCD to Seven Segment Decoder.....	MASTER DISPLAY	2.80
2	5A-8972	MC6820 Peripheral Interface Adapter (PIA)....	CPU & DRIVER	9.50 ea.
1	5A-8973	7408 Quad AND Gate.....	CPU	.88
1	5A-8974	7406 Open Collector Hex Inverter.....	DRIVER	1.00
6	5A-8976	2N6427 NPN Darlington Transistor.....	DRIVER	.58 ea.
6	5A-8977	TIP120 NPN Darlington Power Transistor.....	DRIVER	1.56 ea.
2	5A-8978	TIP42 PNP Power Transistor.....	DRIVER	1.34 ea.
1	5A-8987	MC6800 Microprocessor Unit (MPU).....	CPU	18.50
1	5A-8988	MC6875 Clock Chip.....	CPU	7.26
1	5A-9003	MC6810 256 x 8 RAM.....	CPU	7.84
1	5A-9007	68316 2K x 8 ROM (Lower Background).....	CPU	16.40
1	5A-9008-1	68316 2K x 8 ROM (Upper Background).....	CPU	16.40
1	5A-9017	5101 256 x 4 CMOS RAM.....	CPU	17.50
1	5A-9020	3.58 MHz. Color Burst Crystal.....	CPU	2.34
1	5A-9024	SPDT Momentary Switch.....	CPU	4.00
2	5A-9049	3 Amp 5 V. Voltage Regulator.....	POWER SUPPLY	13.20 ea.
1	5A-9057	SDS201 NPN Transistor.....	POWER SUPPLY	1.08
1	5A-9058	SDS202 PNP Transistor.....	POWER SUPPLY	1.30
2	5A-9060	1N4764 Zener Diode.....	POWER SUPPLY	.42 ea.