

SEGA™

MAVERICK

THE MOVIE



SEGA Pinball, Inc.
1990 Janice Avenue
Melrose Park, IL 60160
☎ 1-708-345-7700
FAX 1-708-345-7889
1-800-KICKERS

MAVERICK, characters, names, and all related indicia are trademarks of Warner Bros. © 1993, 1994

JOE BLACKWELL
Director, Technical Support

ERIC WINSTON
Technical Support Engineer

JAY ALFER
Tech. Documentation Admin.

STEVE NOVAK
Technical Support Manager

Copyright © 1994
SEGA Pinball, Inc. Subsidiary of SEGA Enterprises, Inc.

780-5031-00

Playfield Overview and Game Rules

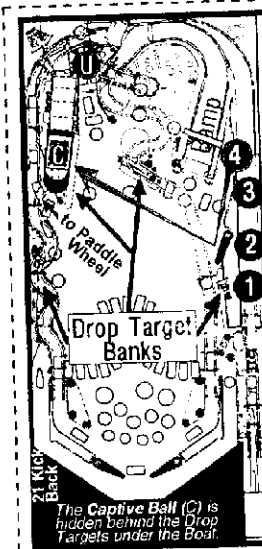
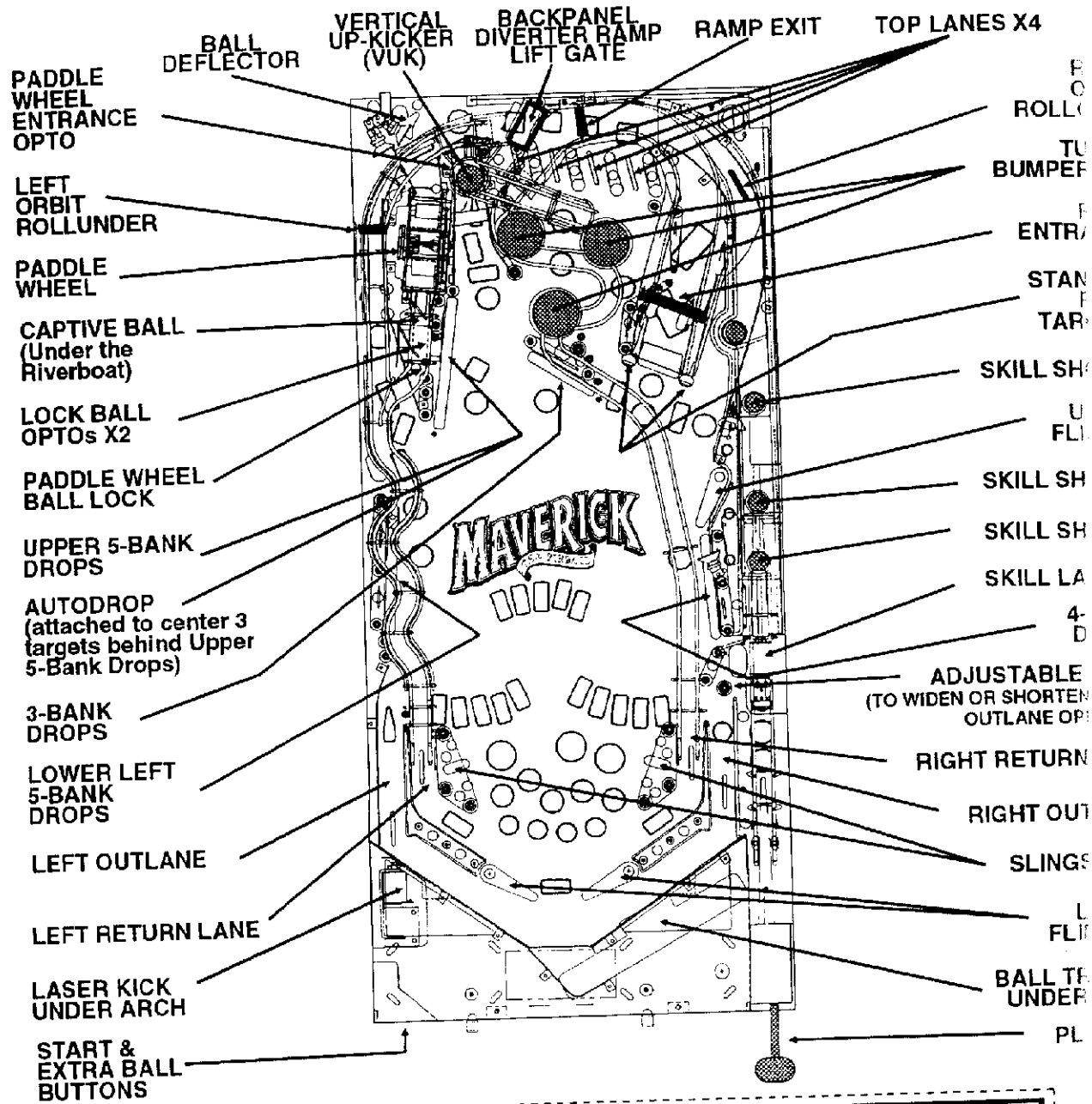

♣ ♦ ♠ ♥ **Maverick, The Movie** ♣ ♦ ♠ ♥

SKILL SHOT Shoot ①, ②, or ③ for Award, or ④ for "flipper skill shot" by hitting the **Captive Ball (C)** under the Riverboat.

MULTIBALL Shoot **Ramp** to score Jokers - 3 Jokers lights Paddle Wheel for ball lock. Lock balls inside the Riverboat to enable **Multiball**.

JACKPOTS Shoot Ramp for **Multiball Jackpots**, then complete all Drop Targets to light **Super Jackpot** at the Ramp.

PLAYING POKER Shoot cards on the lit bank(s) to win chips. Shoot **Up-Kicker (U)** to **Raise** or **Fold**. Cards on unlit banks score discards - complete your hand before discards reach zero.

CHIP FEATURES Win 5 chips to start a Chip Feature.

'21' Play Blackjack at **Up-Kicker** to relight **21 Kick Back**.

Hint Pressing the Extra Ball Buyin Button during the course of a game activates the **Extra Ball Buyin Feature** at the end of game play!

© 1994 Data East Pinball, Inc. 755-5068-00 Copy

copy & cut

Game Operation & Features

MAVERICK

THE FINAL

GAME RULES

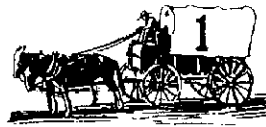
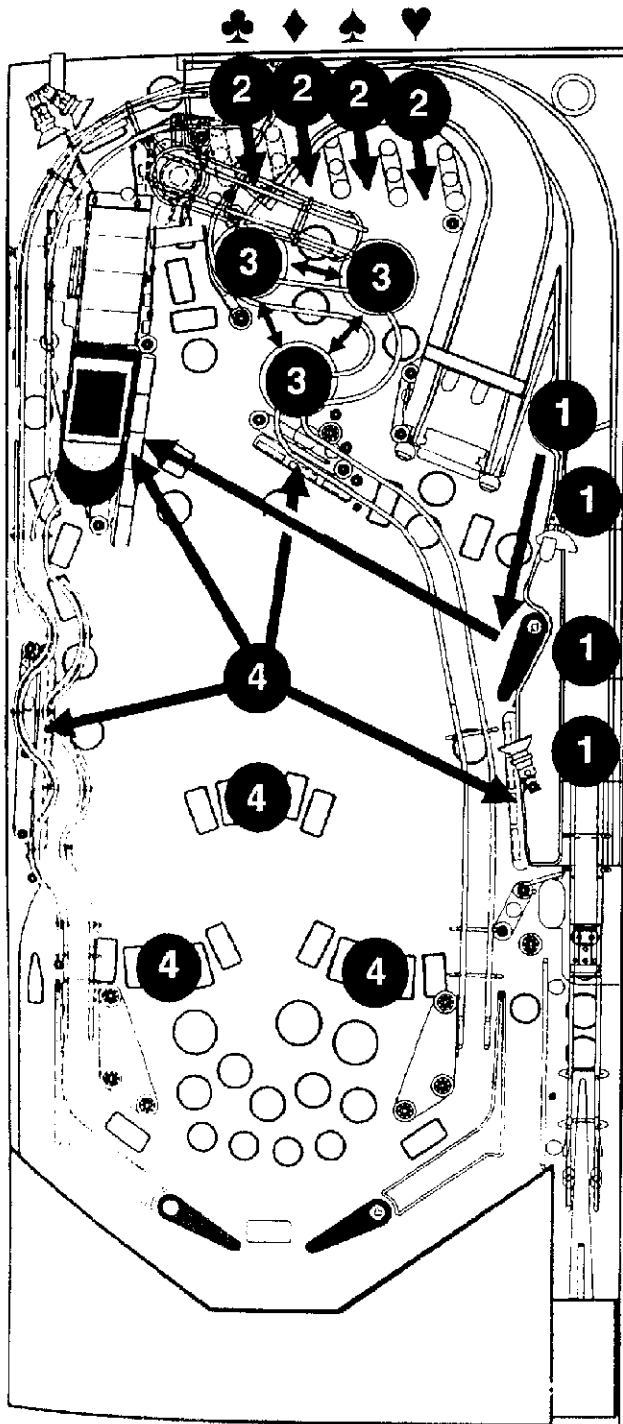

1 Plunger Skill Shots

Shoot the ball into the desired hole 1, 2 or 3 to collect the award indicated in the display. Shoot the ball into the unmarked hole, then hit the ball with the upper flipper into the **Captive Ball** under the *Riverboat* to start Drop Poker.



2 Card Suits (Top Lanes)

Completing the top lanes advances the bonus multiplier: 2X, 4X, 6X, 8X, to 10X. Subsequent completions score 20M. Use *flipper buttons* to change position of any lit lanes. BonusX resets at the start of each ball.



3 Turbo Bumpers

Turbo Bumpers start at 250K per hit each ball and increase by 250K every 10 hits up to a maximum of 1M.



4 Playing Poker

In regular single-ball play, players must beat the poker hand held by the characters on the playfield. Players must complete the *flashing target bank* to beat the playfield's hand.

When the Playfield Character Holds:	Player Must Shoot:
Ace of Spades	Pair (Ramp Stand-Ups)
Pair of Tens	3-Of-A-Kind (3-Bank) Full House (Ramp Stand-Ups & 3-Bank)
3-Of-A-Kind	Straight (Upper 5-Bank)
Full House	4-Of-A-Kind (Right 4-Bank)
Straight Flush	Royal Flush (Lower 5-Bank)

continued next page

MAVERICK

THE FINAL

GAME RULES



4 Playing Poker cont.

While completing their hands, players have a limited number of **DISCARDS** as shown on the display. Hitting a card on an unlit target bank counts as a discard - and players must complete their hand before they run out of discards! If they do, they win the hand and a 5M chip, otherwise the player loses the hand.

Accumulate five (5) 5M chips to win a 25M chip and start a **Maverick Feature**.



5 Spot Card

Players who quickly shoot the **VUK** after the ball rolls through either return lane succeed in sneaking a card that they need into their hand!



6 Raise or Fold

Players can **RAISE** or **FOLD** on every hand dealt by shooting the **VUK** and pressing the indicated flipper button. Players who **RAISE** could win two 5M chips on their current hand - those who **FOLD** lose nothing and play continues as a new hand is dealt.



7 Winning Streak

Players multiply their chip value by the number of consecutive hands won. Winning a regular hand results in 5M x *Winning Streak*. Winning a hand after a **RAISE** awards 10M x *Winning Streak*. Those who **FOLD** **WILL NOT** break their current *Winning Streak*.

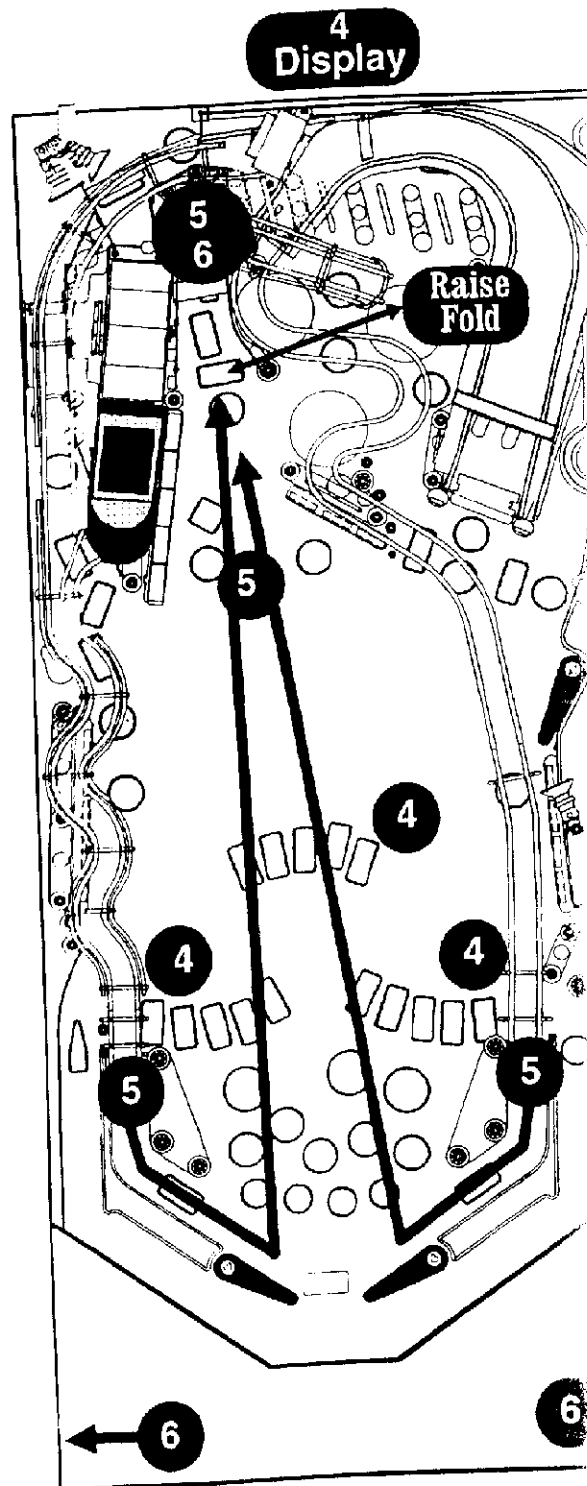

MAVERICK

THE FINALE

GAME RULES

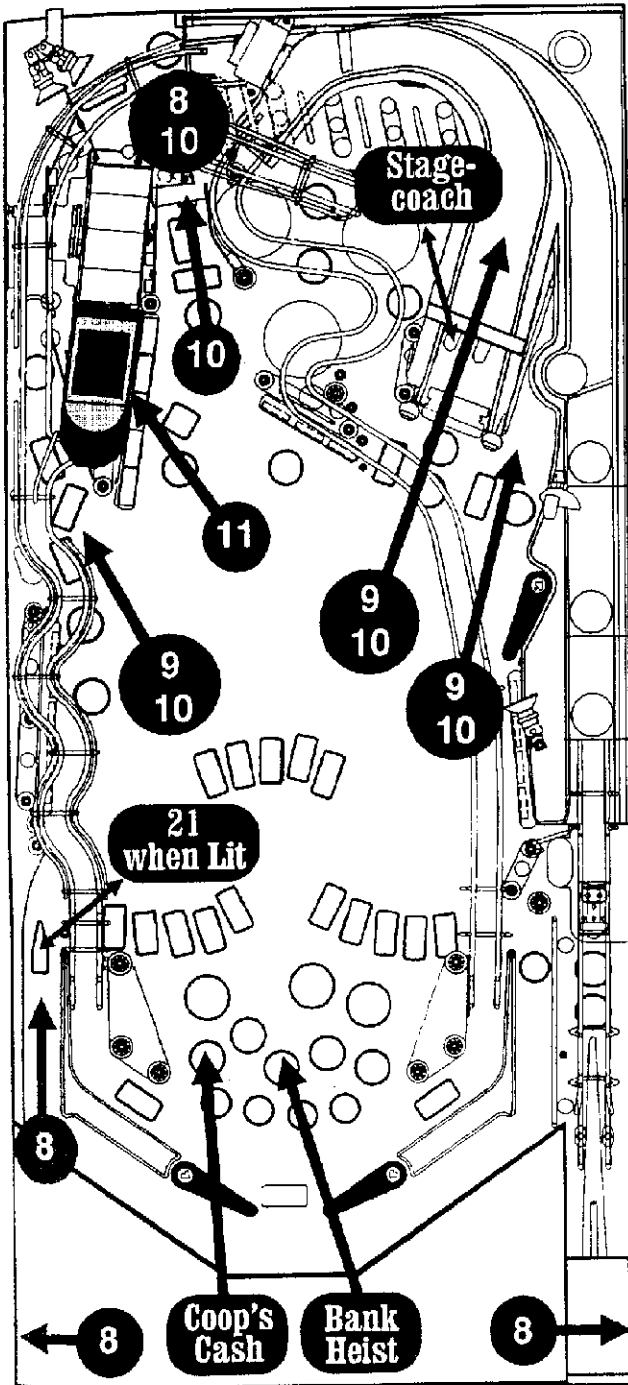

'21' for Kickback

If the *Kickback* is not lit, a shot to the **VUK** will deal a hand of *head-to-head Blackjack*. Players press the indicated *flipper button* to **HIT** or **STAND**. Dealer must **HIT** with 1-16 and **STAND** on 17-21. Players must be closer to 21 than the dealer's hand (without going over) to win. Pushes (ties) go to the player. Winning the hand relights the *Kickback*.

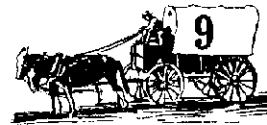

Stagecoach Mystery

11 randomly selected Awards are available for collection at the Stagecoach when lit. Mystery lites at 3, 7, 12, 18, 25, 33, 42 ... *Orbit Shots*. Awards are given in set order during Tournament Play.

Maverick Features:

A Feature is started whenever a player wins 5 chips and acquires a 25M chip.



Coop's Cash

Complete the \$ shots (**Left Orbit**, **VUK**, **Ramp**, and **Right Orbit**) as many times as possible before the timer expires. \$ shots start at 10M each. Completing all four starts a roving \$ shot worth 50M. Hitting the roving \$ adds 10M to the value of the four \$ shots and the feature restarts!



Bank Heist

Shoot the **Captive Ball** up to 3 times to rob the bank before the timer runs out. Value of the loot is 100M X number of hits.

MAVERICK

THE FINBALL

GAME RULES

Maverick Features cont.:



12 Lauren Belle

Shoot for the **Paddle Wheel** to collect as many **Mystery** payoffs as possible from the **Video Slot Machine** before the timer expires. The more times the player shoots the **Paddle Wheel**, the more liberal the payoffs from the slot machine become!

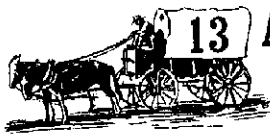

13 Angel's Revenge

Fast scoring in the **Wild West** - every switch scores 250K and adds 250K to the escrow bounty. Every 10 switch closures advance the award 250K while time remains. Shoot the **VUK** to collect the escrow bounty.



14 Stagecoach

Stop the runaway Stagecoach before it plummets off the cliff! Ramp Shots move **Maverick** into position and collect a progressive award = 1M per Drop Target + 10M per Ramp Shot as long as time remains.



15 Poker Championship

Knock down cards on all **Drop Targets** then shoot the **VUK** to collect the **Championship Pot**. **Drop Target Banks** add 1M x number of balls in play to the **Championship Pot**. Completing **Banks** adds 10M x number of balls in play to the pot and resets the **Banks**. Shooting the **Captive Ball** adds 100M to the pot. Balls lost before the timer runs out are returned to the player to be plunged back into play!

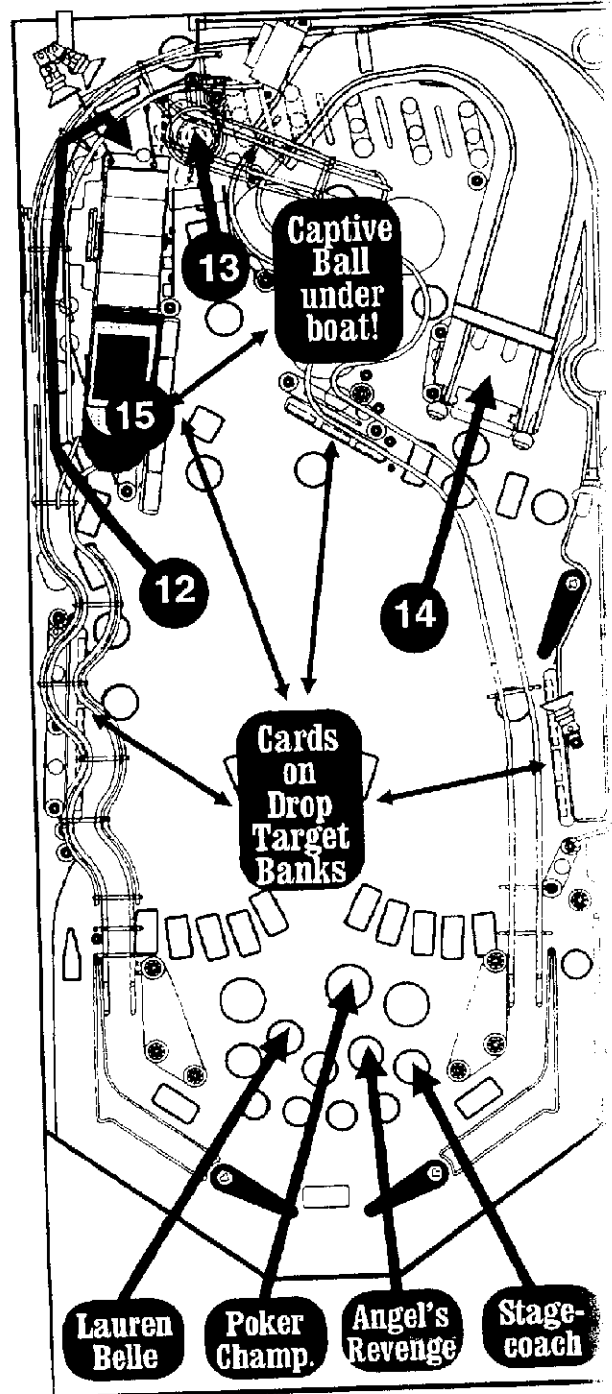

MAVERICK

THE FINEBALL

GAME RULES

Multiball Features:

20 Bonus

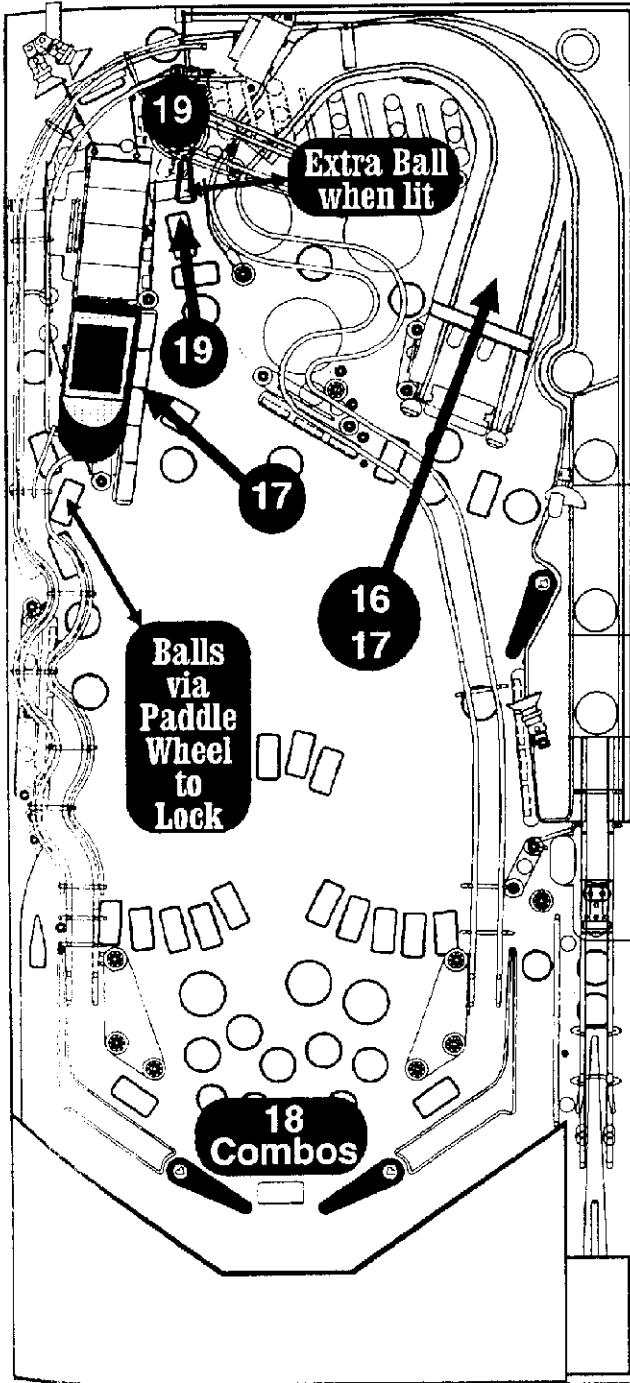

16 Multiball Ready

Shoot the **Ramp** to score Jokers - Collecting 3

Jokers lights Paddle Wheel for ball lock. Lock balls inside the Riverboat to enable **Multiball**.



17 Multiball Jackpots

Shoot Ramp for **Multiball Jackpots**, then complete

all Drop Targets to light **Super Jackpot** at the **Ramp**.

Sharpshooting:



18 Combination Shots

Maverick features several multi-way combos. These

combos involve natural sequences of key shots in the game. Several undocumented difficult combos may also be present.



19 Extra Ball

Extra Ball is collected at the **VUK** whenever lit

during game play.

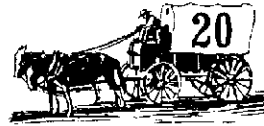

20 Bonus

End of **BALL BONUS** is the sum of:

- ♣ The number of Ramps completed on the Current Ball @ 200K per Ramp.
- ♦ The number of Cards knocked down on the Current Ball @ 200K per card.
- ♠ All Poker Chips won @ 1M per chip times the currently earned bonus multiplier.
- ♥ **BONUS** = [Ramp Shots x 200K + Cards down x 200K + Chips x 1M] x BonusX.

SWITCH TESTS

Switches are configured in an 8 x 8 matrix of columns (switch drives) and rows (switch returns) with up to 64 switches possible. The switch tests include three parts; switch test, active switches, and bad switches. Column and Row wire colors are indicated in each test using corresponding resistor color code numbers.

Switch Test

To initiate, push the STEP push-button switch, until the display indicates **SWITCH TEST**. Close each switch and observe the display. The display will indicate the switch name, column wire colors, row wire colors and the switch number. When a switch is released, the name and number disappear until another switch is closed or the test is exited.

Active Switches

Push the STEP push-button switch from the Switch Test. The display will indicate **ACTIVE SWITCHES**. If switches are stuck closed (or made from the presence of a ball), the display sequences through switch names and indicates the row and column wire colors, and the switch numbers are indicated in the display. This test continues until all switches are cleared or until the STEP push-button switch is depressed.

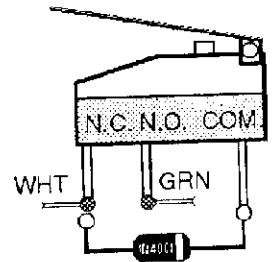
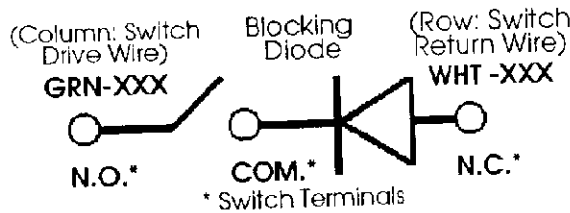

SWITCH MATRIX CHART

Column (Drive) Row (Return)	1 GRN-BRN CN8-1	2 GRN-RED CN8-2	3 GRN-ORN CN8-3	4 GRN-YEL CN8-4	5 GRN-BLK CN8-5	6 GRN-BLU CN8-7	7 GRN-VIO CN8-8	8 GRN-C CN8
1 WHT-BRN CN10-9	Plumb Tilt 1	Not Used 9	Lower Left 5-Bank D.T. Bottom 10♣ 17	Upper Left 5-Bank R/O D.T. Bottom 3♣ 25	Right 4-Bank D.T. Bottom 9♣ 33	Left Turbo Bumper 41	Right Outlane 49	Left Outlane 57
2 WHT-RED CN10-8	4th Coin 2	Not Used 10	Lower Left 5-Bank D.T. Lwr. Middle 4♣ 18	Upper Left 5-Bank R/O D.T. Lwr. Mid. 4♣ 26	Right 4-Bank D.T. Lwr. Middle 9♣ 34	Center Turbo Bumper 42	Right Ramp Left S-U Target 50	Right Ramp Target 58
3 WHT-ORN CN10-7	Credit Button 3	#1 (Left) Ball Trough 11	Lower Left 5-Bank D.T. Middle 9♣ 19	Upper Left 5-Bank R/O D.T. Middle 5♣ 27	Right 4-Bank D.T. Upr. Middle 9♣ 35	Right Turbo Bumper 43	Right Slingshot 51	Left Slingshot 59
4 WHT-YEL CN10-6	Right Coin 4	#2 Ball Trough 12	Lower Left 5-Bank D.T. Upr. Middle K♣ 20	Upper Left 5-Bank R/O D.T. Upr. Mid. 6♣ 28	Right 4-Bank D.T. Top 9♣ 36	Right Ramp Enter Gate 44	RT Ramp Kick Big Bottom 52	Right Ramp Kick Small 60
5 WHT-GRN CN10-5	Center Coin 5	#3 Ball Trough 13	Lower Left 5-Bank D.T. Top A♣ 21	Upper Left 5-Bank R/O D.T. Top 7♣ 29	Top Lane Left 37	Paddle Wheel Front Lock OPTO 45	RT Ramp Skill Shot 1 53	Left Ramp Skill Shot 1 61
6 WHT-BLU CN10-3	Left Coin 6	#4 Ball Trough 14	Center 3-Bank D.T. Left 8♣ 22	Captive Ball S-U Target 30	Top Lane MID LT 38	Paddle Wheel Back Lock OPTO 46	RT Ramp Skill Shot 2 54	Left Ramp Skill Shot 2 62
7 WHT-VIO CN10-2	Slam Tilt 7	#5 (Right) Ball Trough 15	Center 3-Bank D.T. Middle 8♣ 23	VUK 31	Top Lane MID RT 39	Right Return Lane 47	RT Ramp Skill Shot 3 55	Left Ramp Skill Shot 3 63
8 WHT-GRY CN10-1	Extra Ball Button 8	Shooter Lane 16	Center 3-Bank D.T. Right 8♥ 24	Upper RT Ramp Exit Gate 32	Top Lane Right 40	Not Used 48	Paddle Wheel Entrance (on P/F) OPTO 56	Left Ramp Skill Shot 4 64

Switch Matrix Locations, Descriptions & Switch Part Numbers†

Switch Matrix No. & Description	Part No.
01* Plumb Tilt (See Item 17, Cabinet Parts, Page 41)	
02* 4th Coin (On Coin Door)	---
03* Credit Button (Left of Coin Door)	500-5097-02
04* Right Coin (On Coin Door)	180-5024-00
05* Center Coin (On Coin Door)	180-5024-00
06* Left Coin (On Coin Door)	180-5024-00
07* Slam Tilt	180-5022-00
08* Extra Ball Button (Under 03)	180-5073-00
09 Not Used	---
10 Not Used	---
11 #1 (Left) Ball Trough	180-5119-00
12 #2 Ball Trough	180-5119-00

Switch Matrix No. & Description	Part No.
13 #3 Ball Trough	180-5119-00
14 #4 Ball Trough	180-5119-00
15 #5 (Right) Ball Trough	180-5118-00
16 Shooter Lane	180-5100-01
17 Lower Left 5-Bank D.T. Bottom 10♣	180-5104-00
18 Lower Left 5-Bank D.T. Lwr. MID J♣	180-5104-00
19 Lower Left 5-Bank D.T. Middle Q♣	180-5104-00
20 Lower Left 5-Bank D.T. Upr. MID K♣	180-5104-00
21 Lower Left 5-Bank D.T. Top A♣	180-5104-00
22 Center 3-Bank D.T. Left 8♣	180-5104-00
23 Center 3-Bank D.T. Middle 8♦	180-5104-00
24 Center 3-Bank D.T. Right 8♥	180-5104-00
25 Upr. LT 5-Bank Rollover D.T. BOT 3♣	180-5104-00
26 Upr. LT 5-Bank R/O D.T. Lwr. MID 4♣	180-5104-00
27 Upr. LT 5-Bank R/O D.T. Middle 5♦	180-5104-00
28 Upr. LT 5-Bank R/O D.T. Upr. MID 6♣	180-5104-00
29 Upr. LT 5-Bank Rollover D.T. Top 7♣	180-5104-00
30 Captive Ball Stand-Up Target	515-5967-08
31 Vertical Up-Kicker (YUK)	180-5116-00
32 Upper Right Ramp Exit Gate	180-5087-00
33 Right 4-Bank Drop Target Bottom 9♣	180-5104-00
34 Right 4-Bank D.T. Lower Middle 9♦	180-5104-00
35 Right 4-Bank D.T. Upper Middle 9♣	180-5104-00
36 Right 4-Bank Drop Target Top 9♥	180-5104-00
37 Top Lane Left	500-5707-00
38 Top Lane Middle Left	500-5707-00
39 Top Lane Middle Right	500-5707-00
40 Top Lane Right	500-5707-00
41 Left Turbo Bumper	180-5015-01
42 Center Turbo Bumper	180-5015-01
43 Right Turbo Bumper	180-5015-01
44 Right Ramp Entrance Gate	180-5090-00
45 Paddle Wheel Transmitter Front Lock OPTO Receiver	520-5102-00 520-5103-00
46 Paddle Wheel Transmitter Back Lock OPTO Receiver	520-5102-00 520-5103-00
47 Right Return Lane	500-5706-00
48 Not Used	---
49 Right Outlane	500-5706-00
50 Right Ramp Left Stand-Up Target	515-5967-08
51 Right Slingshot	180-5054-00
52 Right Ramp Kick Big Bottom	500-5706-00
53 Right Ramp Skill Shot 1	500-5706-00
54 Right Ramp Skill Shot 2	500-5706-00
55 Right Ramp Skill Shot 3	180-5126-00
56 Paddle Wheel Transmitter Entrance OPTO Receiver	520-5102-00 520-5103-00
57 Left Outlane	500-5707-00
58 Right Ramp Right Stand-Up Target	515-5967-08
59 Left Slingshot	180-5054-00
60 Right Orbit Rollover	500-5707-00
61 Left Orbit Rollunder	180-5090-00
62 Left Return Lane	500-5707-00
63* Lower Left Flipper Cabinet via Q7 (Transistor) on SSFB	180-5124-00
64* Lower & Upper Right Flipper Cabinet via Q5 (Transistor) on SSFB	180-5124-00

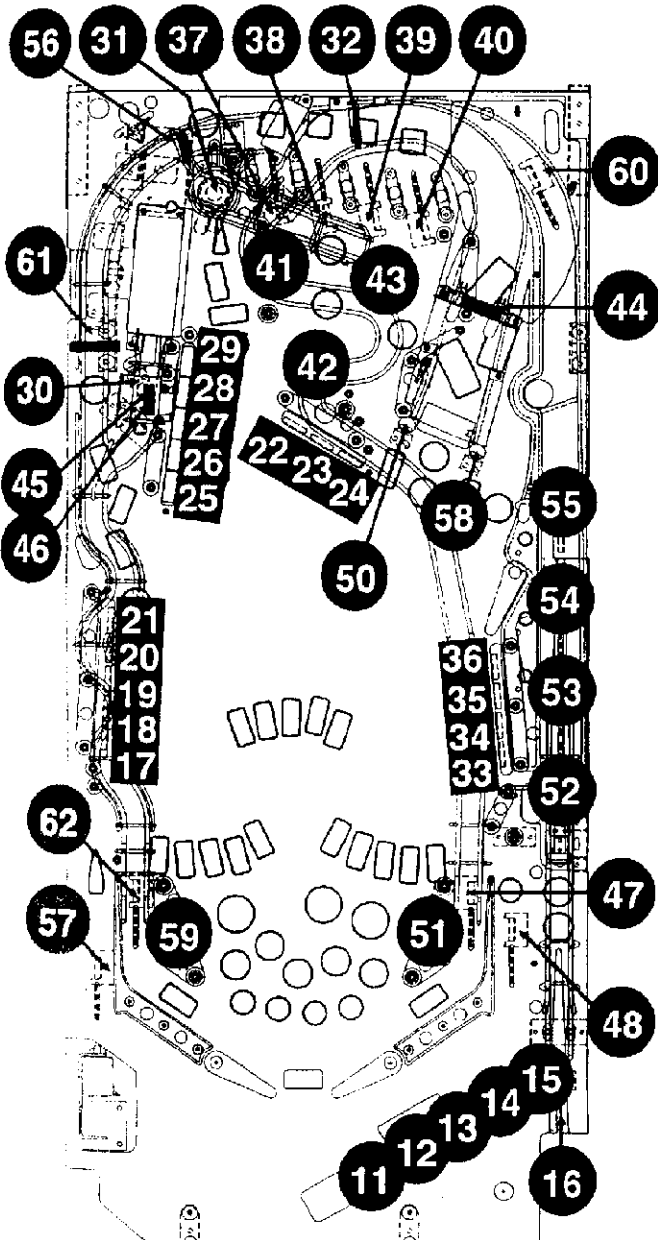

* Location - In Cabinet

† Specify Game N° (31) & decal description if applicable.

LAMP TESTS

Controlled lamps are configured in an 8 x 8 matrix of columns (lamp drives) and rows (lamp returns) with up to 64 lamps possible. The lamp tests include four parts, all lamps, lamp return (row), lamp drive (column), and disc (individual) lamps. Row and column wire colors are indicated in the discrete lamp test using corresponding resistor color code numbers.

All Lamps

From the Active Switch test, operate the STEP push-button switch. The dot matrix display will indicate ALL LAMP and all controlled lamps will light.

Lamp Returns (Row)

From the ALL LAMPS test, depress the STEP push-button switch. The display indicates LAMP RETURNS, color and the LAMP RETURN driver transistor. All controlled lamps in row 1 should be lit. Operating the Game Start push-button switch cycles through each of the rows separately.

Lamp Drives (Column)

From the LAMP RETURNS test, depress the STEP push-button switch. The display will indicate LAMP COLUMN wire color and the LAMP DRIVES driver transistor. All controlled lamps in column 1 should be lit. Operating Game Start push-button switch, cycles through each of the columns separately.

Single Lamp

From the LAMP DRIVES test, depress the STEP push-button switch. The display will indicate the lamp name. The display indicates the row and column wire colors and the lamp matrix number. Lamp 01 should light. With FORWARD/REVERSE push-button switch in the FORWARD (up) position, operating the Game Start push-button switch selects higher-numbered lamps; with it in the REVERSE (down) position, Game Start selects lower-numbered lamps.

LAMP MATRIX CHART

Column 18V Row GND	1 Q71 YEL-BRN CN7-1	2 Q70 YEL-RED CN7-2	3 Q69 YEL-ORN CN7-3	4 Q68 YEL-BLK CN7-4	5 Q67 YEL-GRN CN7-6	6 Q66 YEL-BLU CN7-7	7 Q65 YEL-VIO CN7-8	8 Q64 YEL-GRY CN7-9
1 Q72 RED-BRN CN6-1	Bank Heist (Captive Ball) 01	Shoot Again 09	21 (When Lit) 17	(Left) Turbo Bumper 25	Skill Shot #1 Bottom 33	Top Lane 1 ♣ 41	Ramp Joker #1 (Bottom) 49	4-Of- A-King
2 Q73 RED-BLK CN6-2	Two of Hearts 2♥ 02	Lock #3 ♣ 10	Poker Champion- ship 18	(Center) Turbo Bumper 26	Skill Shot #2 34	Top Lane 2 ♦ 42	Ramp Joker #2 (Middle) 50	3-Of- A-King
3 Q74 RED-ORN CN6-3	Three of Hearts 3♥ 03	Special 11	Lock #2 ♣ 19	(Right) Turbo Bumper 27	Skill Shot #3 35	Top Lane 3 ♠ 43	Ramp Joker #3 (Top) 51	Straight
4 Q75 RED-YEL CN6-5	Four of Hearts 4♥ 04	Jackpot (Right Ramp Enter Right) 12	Coop's Cash 20	Lock #1 ♣ 28	Not Used 36	Top Lane 4 ♥ 44	Stagecoach (Right Ramp Enter Left) 52	Royal Flush
5 Q76 RED-GRN CN6-6	Five of Hearts 5♥ 05	Not Used 13	Lauren Belle 21	5 Mil (1) (Left) 29	10 of Clubs / Diamonds 10♣ 10♦ 37	Ace of Spades A♠ 45	Seven of Clubs 7♣ 53	Two of Diamonds 2♦
6 Q77 RED-BLU CN6-7	Six of Hearts 6♥ 06	Spot Card (Left) 14	Bank Heist 22	5 Mil (2) (Middle Left) 30	Extra Ball 38	10 of Spades / Hearts 10♠ 10♥ 46	Seven of Diamonds 7♦ 54	Two of Clubs 2♣
7 Q78 RED-VIO CN6-8	Jack of Spades J♠ ('21') 07	Spot Card (Right) 15	Angel's Revenge 23	5 Mil (3) (Middle Right) 31	\$ (Right Orbit) (#4) 39	\$ (VUK) (#2) 47	Six of Clubs / Diamonds 6♣ 6♦ 55	Extra Ball Button
8 Q79 RED-GRY CN6-9	Raise/ Fold 08	1 (One) Pair 16	Stage Coach 24	5 Mil (4) (Right) 32	\$ (Ramp Enter) (#3) 40	\$ (Left Orbit) (#1) 48	Seven of Hearts 7♥ 56	Start Button

Lamp Matrix Location and Descriptions

Lamp Matrix No. & Description	Lamp Matrix No. & Description	Lamp Matrix No. & Description
01 Bank Heist (Captive Ball)	24 Stage Coach	46A Ten of Spades 10♠
02 Two of Hearts 2♥	25 (Left) Turbo Bumper	46B Ten of Hearts 10♥
03 Three of Hearts 3♥	26 (Center) Turbo Bumper	47 \$ (VUK) (#2)
04 Four of Hearts 4♥	27 (Right) Turbo Bumper	48 \$ (Left Orbit) (#1)
05 Five of Hearts 5♥	28 Lock #1 (Joker)	49 Ramp Joker #1 (Bottom)
06 Six of Hearts 6♥	29 5 Mil (1) (Left)	50 Ramp Joker #2 (Middle)
07 Jack of Spades J♠ ('21')	30 5 Mil (2) (Middle Left)	51 Ramp Joker #3 (Top)
08 Raise / Fold	31 5 Mil (3) (Middle Right)	52 Stagecoach (Right Ramp Enter Left)
09 Shoot Again	32 5 Mil (4) (Right)	53 Seven of Clubs 7♣
10 Lock #3 (Joker)	33 Skill Shot #1 (Bottom)	54 Seven of Diamonds 7♦
11 Special	34 Skill Shot #2 (Center)	55A Six of Clubs 6♣
12 Jackpot (RT Ramp Enter Right)	35 Skill Shot #3 (Top)	55B Six of Diamonds 6♦
13 Not Used	36 Not Used	56 Seven of Hearts 7♥
14 Spot Card (Left)	37A Ten of Clubs 10♣	57 4-Of-A-Kind
15 Spot Card (Right)	37B Ten of Diamonds 10♦	58 3-Of-A-Kind
16 1 (One) Pair	38 Extra Ball	59 Straight
17 21 When Lit	39 \$ (Right Orbit) (#4)	60 Royal Flush
18 Poker Championship	40 \$ (Ramp Enter) (#3)	61 Two of Diamonds 2♦ (Stand-Up Right)
19 Lock #2 (Joker)	41 Top Lane 1 ♣	62 Two of Clubs 2♣ (Stand-Up Left)
20 Coop's Cash	42 Top Lane 2 ♦	63* Extra Ball Button (Front of Cab.)
21 Lauren Belle	43 Top Lane 3 ♠	64* Start Button (Front of Cabinet)
22 Bank Heist	44 Top Lane 4 ♥	
23 Angel's Revenge	45 Ace of Spades A♠	

Please Note:
 General Illumination (G.I.)
 Lamps are not shown.
 For Bulb Types & Sockets,
 see pages 46 & 47

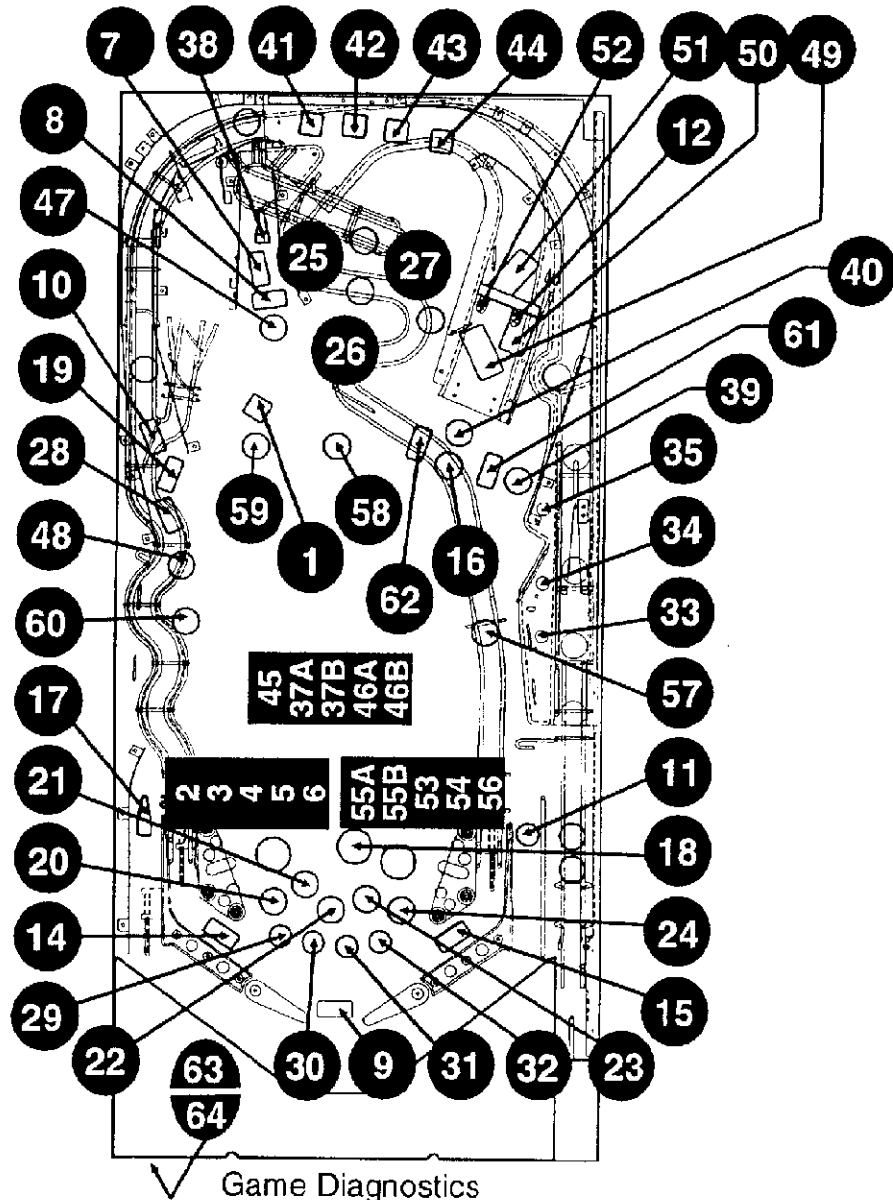

FLASH LAMP / COIL TESTS

Twenty-Two regular (pulsed under microprocessor control) coil drivers are provided to switch ground to coil. The Left/Right relay is used in conjunction with drives 1 through 8 to switch +32 volts between coils or flash lamp. These sets are termed "left" and "right". This relay is located on the PPB board which provides isolation diodes and current limiting resistors. This effectively provides 29 regular coils.

Flash Lamp	From the Single Lamp test, depress the STEP push-button switch. All Flash lamps will fire randomly. This allows the Technician to easily spot any burned out bulbs and replace them without stepping through the tests below.
Automatic Test	From the Flash Lamps test, depress the STEP push-button switch. The dot matrix display will indicate A COILS . The test pulses each regular solenoid or flash lamp sequentially with the coil/flash lamp names and the wire colors indicated in the display.
Select Coil	From the Coil Test, depress the STEP push-button switch. The display will indicate SELECT COIL and the name of 1st drive and the wire colors. Operate either Flipper push-button switch to select the coil or flash lamp to be tested. With the desired drive number indicated in the display, depress the START push-button switch to cause it to be pulsed repeatedly.
Return To Game Over	From the Select Coil test, depress the STEP push-button switch once. The game returns to the game-over mode.

Backbox Flash Lamps

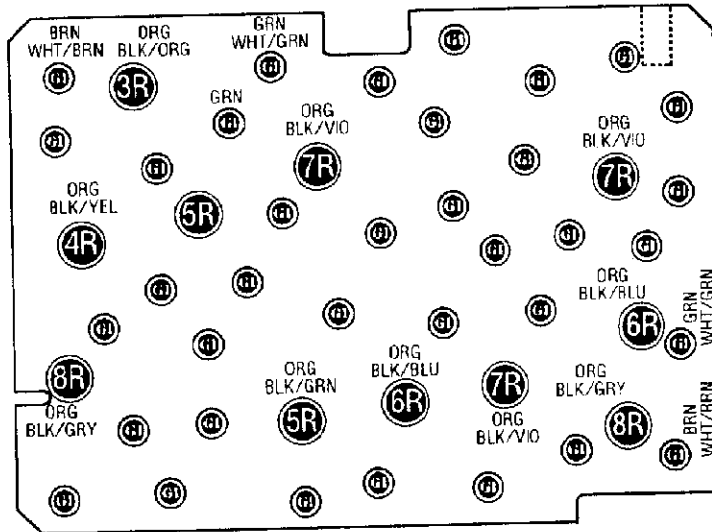

1L	4-Ball Ass'y Lockout	8R	Lwr. LT 5-Bank DT Flash
1R	Skill Shot Flash	09	Platic Ramp Diverter
2L	Ball Release (Eject)	10	Left/Right (A/B) Relay
2R	Jokers Flash	11	G.I. Relay
3L	Skill Shot Launch 50v	12	Ball Lock Assembly
3R	Turbo Bumpers Flash	13	5-Bank Lwr. Left D.T.
4L	5-Bank Autodrop Down	14	Upper VUK 50v
4R	Paddle Wheel Flash	15	Upr. Left Ball Deflector 50v
5L	5-Bank Autodrop Reset Up	16	Paddle Wheel
5R	Lower Left Flash	17	Left Turbo Bumper
6L	3-Bank Drop Target	18	Bottom Turbo Bumper
6R	Right Drop Target Flash	19	Right Turbo Bumper
7L	4-Bank Drop Target	20	Left Slingshot
7R	3-Bank D.T. Flash	21	Right Slingshot
8L	Knocker 32v	22	Laser Kick 50v

Note: Shaded areas not shown on Diagrams.
G.I. General Illumination Lamps

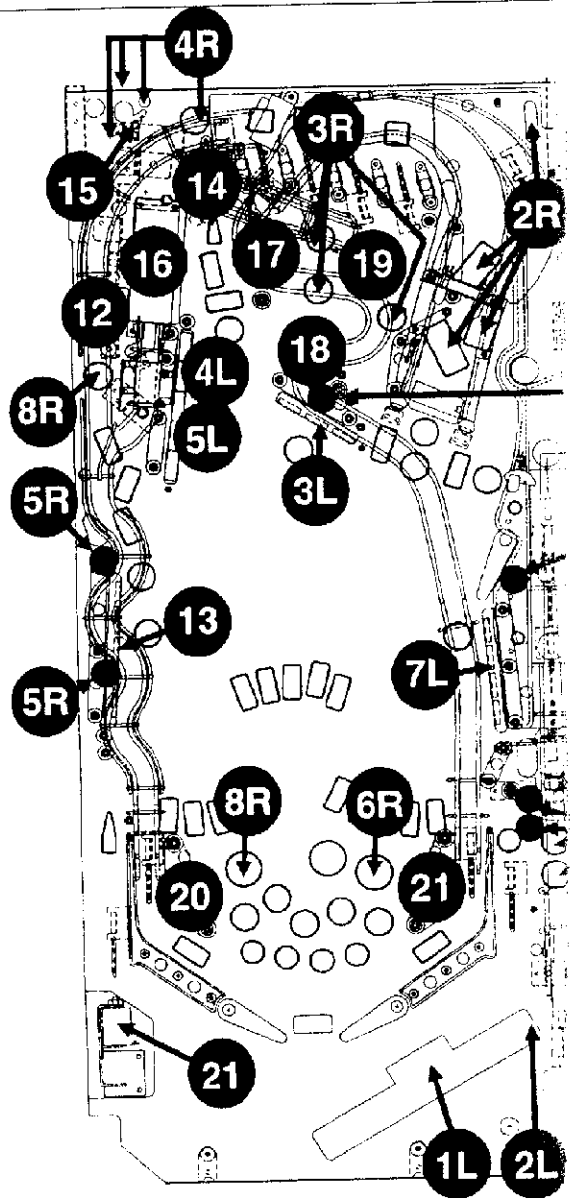

Switched, CPU Controlled Auxillary & Constant Power Solenoids

Coil No.	Coil or Flashlamp Description	Drive Transistor (D.T.)	On Which Board?	D.T. Control Line	D.T. Control Line Connect	Power Line	Power Line Connection	Power Description	Coil or Flash Type
1L	Coil: 4-Ball Assembly Lockout	Q46	CPU	VIO-BRN	PPB J2-1	BRN	PPB J6-1, 2	32v L	25-1240
1R	Flashlamp: X4 P/F, Insert X0 Skill Shot Flash			BLK-BRN	PPB J9-1	ORN	PPB J6-4, 5	32v R	Bulb #89
2L	Coil: Ball Release (Eject)	Q45	CPU	VIO-RED	PPB J2-2	BRN	PPB J6-1, 2	32v L	23-800
2R	Flashlamp: X4 P/F, Insert X0 Jokers Flash			BLK-RED	PPB J9-2	ORN	PPB J6-4, 5	32v R	Bulb #89
3L	Coil: Skill Shot Launch 50v	Q5	PPB	VIO-ORN	PPB J8-2	YEL/VIO	PPB J7-8	50v L	23-800
3R	Flashlamp: X3 P/F, Insert X1 Turbo Bumpers Flash	Q44	CPU	BLK-ORN	PPB J9-3	ORN	PPB J6-4, 5	32v R	Bulb #89
4L	Coil: 5-Bank Autodrop Down	Q43	CPU	VIO-YEL	PPB J2-4	BRN	PPB J6-1, 2	32v L	32-1800
4R	Flashlamp: X3 P/F, Insert X1 Paddle Wheel Flash			BLK-YEL	PPB J9-4	ORN	PPB J6-4, 5	32v R	Bulb #89
5L	Coil: 5-Bank Drop Target	Q4	PPB	VIO-GRN	PPB J8-4	YEL/VIO	PPB J7-8	50v L	23-700
5R	Flashlamp: X2 P/F, Insert X2 Lower Left Flash	Q42	CPU	BLK-GRN	PPB J9-5	ORN	PPB J6-4, 5	32v R	Bulb #89
6L	Coil: 3-Bank Drop Target	Q3	PPB	VIO-BLU	PPB J8-7	YEL/VIO	PPB J7-8	50v L	23-800
6R	Flashlamp: X2 P/F, Insert X2 Right Drop Target Flash	Q41	CPU	BLK-BLU	PPB J9-6	ORN	PPB J6-4, 5	32v R	Bulb #89
7L	Coil: 4-Bank Drop Target	Q40	CPU	VIO-BLK	PPB J2-8	BRN	PPB J6-1, 2	32v L	23-700
7R	Flashlamp: X1 P/F, Insert X3 3-Bank Drop Target Flash			BLK-VIO	PPB J9-7	ORN	PPB J6-4, 5	32v R	Bulb #89
8L	Coil: Knocker 32v (In Cabinet)	Q39	CPU	VIO-GRY	PPB J2-8	BRN	PPB J6-1, 2	32v L	23-800
8R	Flashlamp: X2 P/F, Insert X2 Lower Left 5-Bank D.T. Flash			BLK-GRY	PPB J9-8	ORN	PPB J6-4, 5	32v R	Bulb #89
09	Coil: Plastic Ramp Diverter	Q30	CPU	BRN-BLK	CPU CN 12-1	RED	PS CN 3-6,7	32v	32-1800
10	Coil: Located on PPB In Backbox Left & Right Relay	Q29	CPU	BLK-RED	CPU CN 12-5	RED	PS CN 6-7	32v	24v DC 10A DPDT
11	Coil: Located on Power Supply Bd. G.I. Relay	Q28	CPU	BRN-ORN	CPU CN 12-4	RED	PS CN 3-6,7	32v	24v DC 10A DPDT
12	Coil: Riverboat Post Ball Lock Assembly	Q27	CPU	BRN-YEL	CPU CN 12-5	RED	PS CN 3-6,7	32v	27-1500
13	Coil: 5-Bank Lower Left Drop Target	Q26	CPU	BRN-GRN	CPU CN 12-6	RED	PS CN 3-6,7	32v	23-700
14	Coil: Upper VUK 50v	Q25/Q3	PPB	BRN-BLU	PPB J8-7	VIO-YEL	PPB J7-3	50v	25-1240
15	Coil: Upper Left Wheel Ball Deflector	Q24	CPU	BRN-VIO	CPU CN 12-8	RED	PS CN 3-6,7	32v	27-1500
16	Coil: Paddle Wheel	Q23	CPU	BRN-GRY	CPU CN 12-9	RED	PS CN 3-6,7	32v	Relay
17	Coil: Left Turbo Bumper	Q11	CPU	BLU-BRN	CPU CN 19-7	RED	PS CN 3-6	32v	23-700
18	Coil: Center Turbo Bumper	Q9	CPU	BLU-RED	CPU CN 19-4	RED	PS CN 3-6	32v	23-700
19	Coil: Right Turbo Bumper	Q8	CPU	BLU-ORN	CPU CN 19-3	RED	PS CN 3-6	32v	23-700
20	Coil: Left Silingshot	Q10	CPU	BLU-YEL	CPU CN 19-6	RED	PS CN 3-6	32v	23-800
21	Coil: Right Silingshot	Q12	CPU	BLU-GRN	CPU CN 19-8	RED	PS CN 3-6	32v	23-800
22	Coil: Laser Klok 50v	Q13/Q1	PPB	BLU-BLK	CPU CN 19-9	VIO-YEL	PS CN 3-6	50v	23-800

Flipper Solenoids

SSFB No.	Flipper Coil	Cabinet Switch	Switch Drive	Switch Return	E.O.S.	GND	Flipper 50vDC Power	Flipper 8vAC Hold	Flipper Coil Output
1	Lwr. Rt. Flipper 23-900	BLU-VIO SSFB CN1-7	GRN-GRY CPU CN8-3 TO SSFB CN1-4	WHT-GRY CPU CN10-1 TO SSFB CN1-3	BRN-VIO RT. EOS SW. TO CN1-1	BLK CPU CN5 TO CN1-6	BLK-WHT PPB J7-1, -5 to SSFB CN2-8, -9	GRY-GRN-GRY P/S CN1-10, -11, to SSFB CN2-7, -8	50v 8vAC Q2, Q3, SR1 CN2-7, 8
1	Lwr. Lt. Flipper 23-900	BLU-GRY SSFB CN1-11	GRN-GRY CPU CN8-3 TO SSFB CN1-4	WHT-VIO CPU CN10-2 TO SSFB CN1-5	BRN-GRY LT. EOS SW. TO CN1-9	BLK CPU CN5 TO CN1-5	BLK-WHT PPB J7-1, -5 to SSFB CN2-8, -9	GRY-GRN-GRY P/S CN1-10, -11, to SSFB CN2-7, -8	50v 8vAC Q10, Q9, SR2 CN2-4, 5
1	Upr. Rt. Flipper 23-900	GRY-VIO SSFB CN1-12	GRN-GRY CPU CN8-3 TO SSFB CN1-4	WHT-GRY CPU CN10-2 TO SSFB CN1-10	Not Used	BLK CPU CN5 TO CN1-5	BLK-WHT PPB J7-1, -5 to SSFB CN2-8, -9	GRY-GRN-GRY P/S CN1-10, -11, to SSFB CN2-7, -8	50v 8vAC Q16, Q15, SR3 CN2-1, 2

PARTS IDENTIFICATION

Backbox Parts

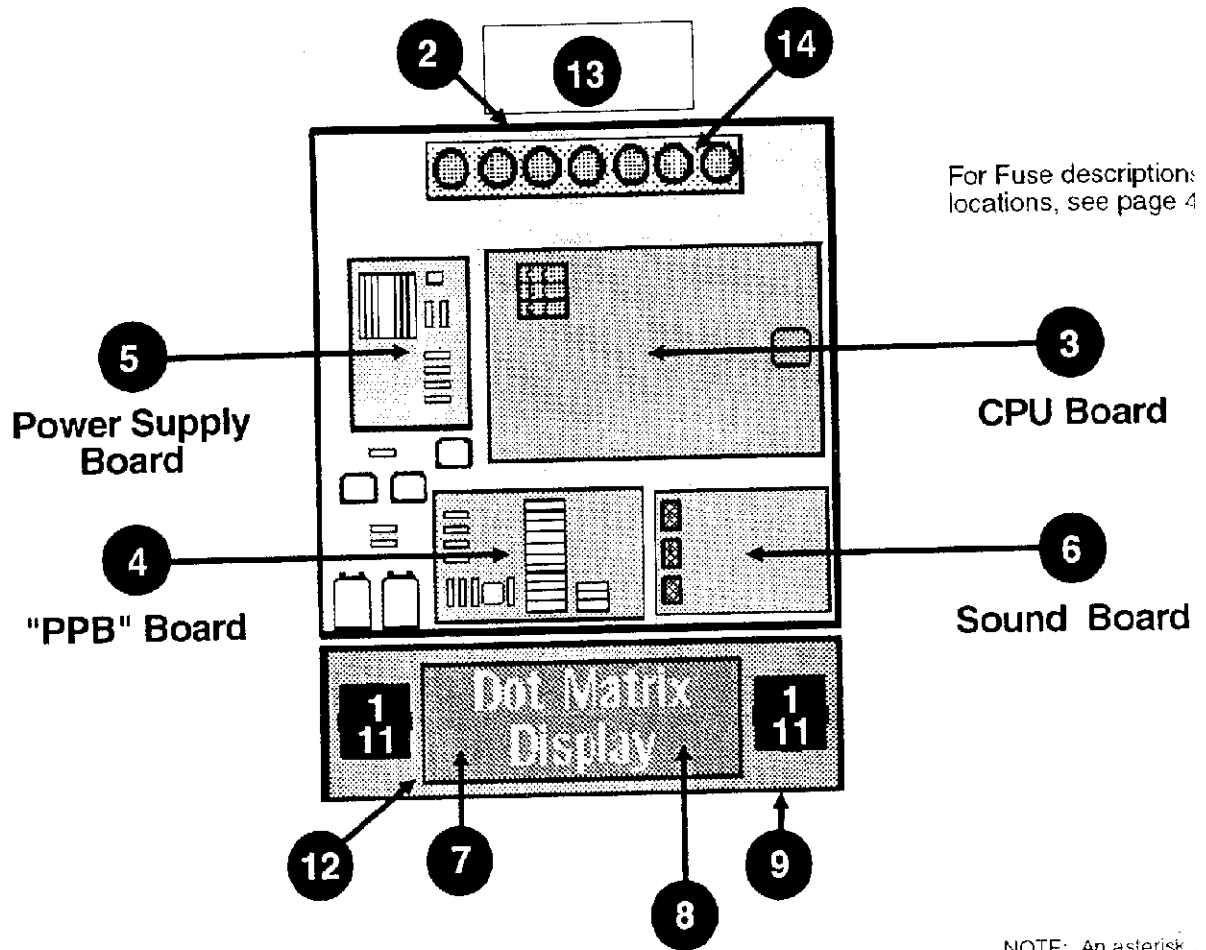

(Display Controller Board Behind 7)

NOTE: An asterisk (*) (shaded items) indicates an item is not noted in this illustration.

Item	Description	Part No.	Item	Description	Part No.
1	Speakers 4X4 Quam 89-9572 (X2)	031-5004-00	15 *	Static Shield *	535-6227-00
2	Back Box Lock	355-5008-00	16 *	Backglass Clear 26½" X 19¾" *	660-5018-00
3	CPU Bd. Non-Reflexive †	520-5003-04	17 *	26-7/16" Plastic Extrusion *	545-5018-00
4	PPB Board Ass'y Rev. C	520-5021-05	18 *	18¾" Plastic Extr. (Qty. 2) *	545-5018-00
5	Power Supply	520-5047-03	19 *	Glass Channel 26-7/16" *	545-5021-00
6	Sound Board 4MB 4MB †	520-5050-03	20 *	GNR Lights Insert *	525-5147-00
7	New Large Dot Matrix Display Board 192 X 64! ††	520-5075-00	21 *	Ribbon Cable, 14-Pin * Display to Display	602-5005-10
8	Display Controller Bd. †	520-5092-01	22 *	Ribbon Cable, 20-Pin * CPU to Sound Board	602-5005-20
9	Speaker Panel Assembly	500-5860-00	23 *	Ribbon Cable, 26-Pin * CPU to Display	602-5005-20
10 *	Maverick Backglass Artwork *	830-5231-00			
11	Maverick Speaker Grill ACE	830-5631-00			
	Mav. Speaker Grill BADGE	830-5631-01			
12	Mav. Speaker Plexi w/ Artwork	830-5630-00			
	Mav. Header Asm.	515-6108-00			
13	Mav. Header Cards Butyrate	830-5466-18			
14	7 Vent Hole Grill 2½" X 18"	545-5072-02			

† When ordering PC Boards with ROMS, please specify the Game Name.

†† Indicate Manufacturer.

PARTS IDENTIFICATION

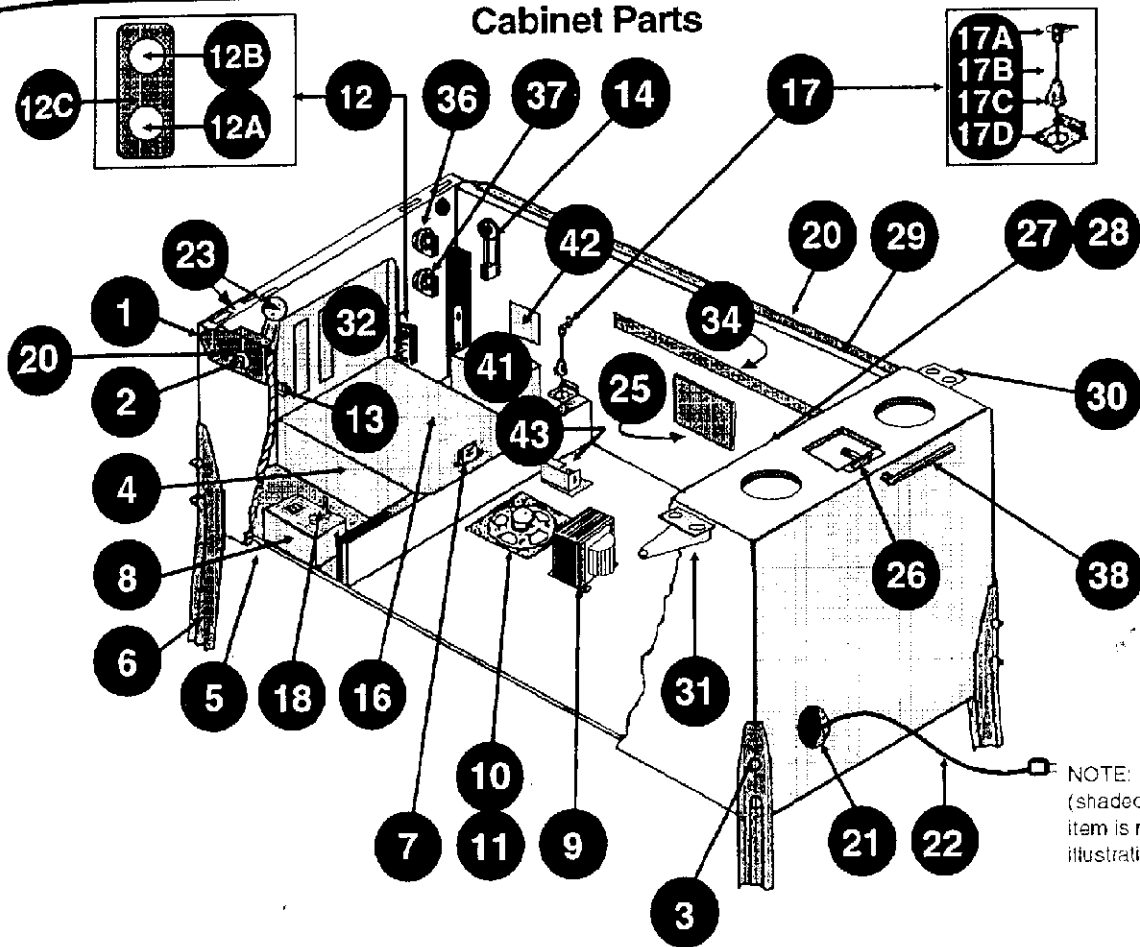

Item	Description	Part No.	Item	Description	Part No.
1	Yellow Poker Chip Shooter Assembly	500-5856-06	19 *	Playfield Glass (T.P.) 21" x 43" *	660-5001-00
2	Flipper Button Red Assy (Solid) (Qty. 2)	500-5026-32	20	Side Armor - Left & Right	535-6831-00
3	Leg Bolt (BLK) 3/8-16 x 2-3/8 Hex Hd. (Qty. 8)	231-5000-01	21	Recessed Cup for Line Cord	545-5122-00
4	Cash Box Plastic Bottom	545-5090-00	22	Line Cord 10' ROJ 3" Maximum	034-5000-10
5	Power Sw. DPST Toggle (Under Cab.)	180-5001-00	23 *	Front Molding Lockdown Assy*	500-5020-01
6	Leg (Black) (Qty. 4)	535-5020-50	24 *	Front Molding - Black *	500-5757-01
	Leg Leveler 3/8-16x3" (Qty. 4) *	500-5017-00	25	Solid State 3-Flipper Board (SSFB)	520-5076-00
7	Cash Box Lock Bracket	535-5215-00	26	#1 Roto Lock Male, (Female -02) *	355-5006-01
8	Service Outlet	180-5008-01	27	Rear Plastic Ext. P/F Glass 20-3/8"	545-5038-00
9	Transformer	010-5008-00	28	Mounting Fm. Rubber for Ext.	626-5001-00
10	Speaker-Round - 8"	031-5005-00	29	Plastic Channel Left & Right	545-5017-00
11	Speaker Grill 7 X 7	535-6830-00	30	Backbox Hinge Left	515-5987-00
12	Dual Switch Assy (Includes 12A-12C)	500-5808-00	31	Backbox Hinge Right	515-5987-01
12A	Memory Protect Switch	180-5000-00	32	Coin Door (w/Validator) USA	500-5018-17
12B	Interlock Switch	180-5136-00	33 *	Slide & Pivot Support Bracket Right*	535-5989-00
12C	Bracket	535-6958-00		Slide & Pivot Support Bracket Left	535-5990-00
13	Service Switch Set (Step Up / Down) Located on the Coin Door By Lock	180-5012-00	34 *	Edge Slide Bracket *	535-5988-00
14	Flipper Switch, Left	180-5122-01		Playfield Support Slide Rev. A *	535-6862-00
15 *	Flipper Switch, Right (Top/Bottom)	180-5048-00	35 *	Playfield Support Bar * (Stay Arm)	535-5019-00
16	Cash Box Cover (Validator)	535-5013-03	36	Start Button Switch Assy (Maverick)	500-5728-05
17	Plumb Bob Tilt Assy (Incl. 17A-17D)	500-5023-00	37	Extra Ball Switch Assy (Orange)	500-5779-07
17A	Hanger Bracket (tilt)	535-5221-00	38	5/16" Hex Key Allen Wrench	777-0001-00
17B	Hanger Wire (tilt) (Attach to "17A")	535-5319-00	39 *	Backbox/Cabinet Matrix/Fuse Info *	820-6104-03
17C	Plumb Bob (tilt) (Attach to "17B")	535-5029-00	40 *	3-Flipper Board Cover *	545-5165-02
17D	Contact Bracket (tilt)	535-5220-00	41 *	Shaker Motor (Not Used This Game)	515-5893-00
18	Volume Control Single 10K Pot	123-5000-02	42 *	Shaker Motor P.C. Board (Not Used)	520-5065-00
			43	Knocker Assembly	500-5081-00

PLAYFIELD - MAJOR ASSEMBLIES †

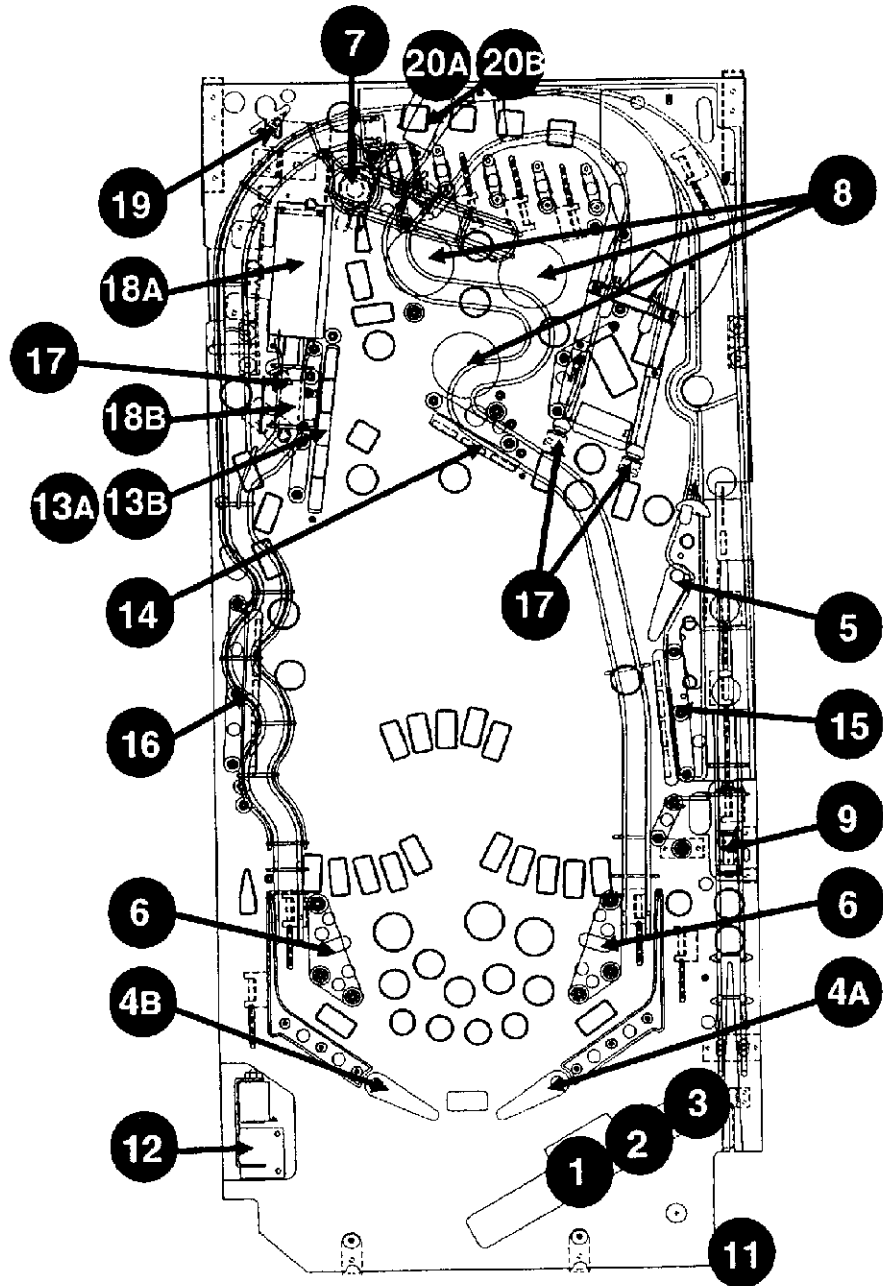

Item	Description	Part No.	Item	Description	Part No.
1	4-Ball Sw. Asm. (Under P/F)	500-5891-00	13A	Maverick 5-Bank Special D.T.	500-5912
2	Lock Ball Asm. (Under Arch)	500-5684-01	13B	Autodrop Asm. (Atch. to 13A)	515-6111
3	Deflector for 4-Ball Asm.	535-6606-01	14	3-Bank Drop Target Assembly	500-5621
4A	Flipper Asm., Lower Right	500-5693-01	15	4-Bank Drop Target Assembly	500-5621
4B	Flipper Asm., Lower Left	500-5693-02	16	5-Bank Drop Target Assembly	500-5799
5	Flipper Asm., Upper Right	500-5914-01	17	Stand-Up Narrow Trgt. (Qty. 2)	500-5857
6	Slingshot Assemblies (Qty. 2)	500-5226-00	18A	Paddle Wheel Assembly	500-5854
7	Vertical Up-Kicker Asm. (VUK)	500-5839-00	18B	Ball Lock Assembly	500-5867
8	Turbo Bumper Asm. (Qty. 3)	500-5227-02	19	Paddle Wheel / Left Orbit Ball Deflector Assembly	500-5888
9	Skill Shot Launch Assembly	500-5862-01	20A	Plastic Ramp Diverter	515-6133
10	Knocker Assembly (In Cabinet)	500-5081-00	20B	Plastic Ramp Gate Asm. (Works with 20A)	515-6133
11	Poker Chip Shooter Asm.	500-5856-06			
12	Laser Kick Back Assembly	500-5838-00			

† See Unique Parts for Major Assembly Breakdowns.

PLAYFIELD - RAMPS †

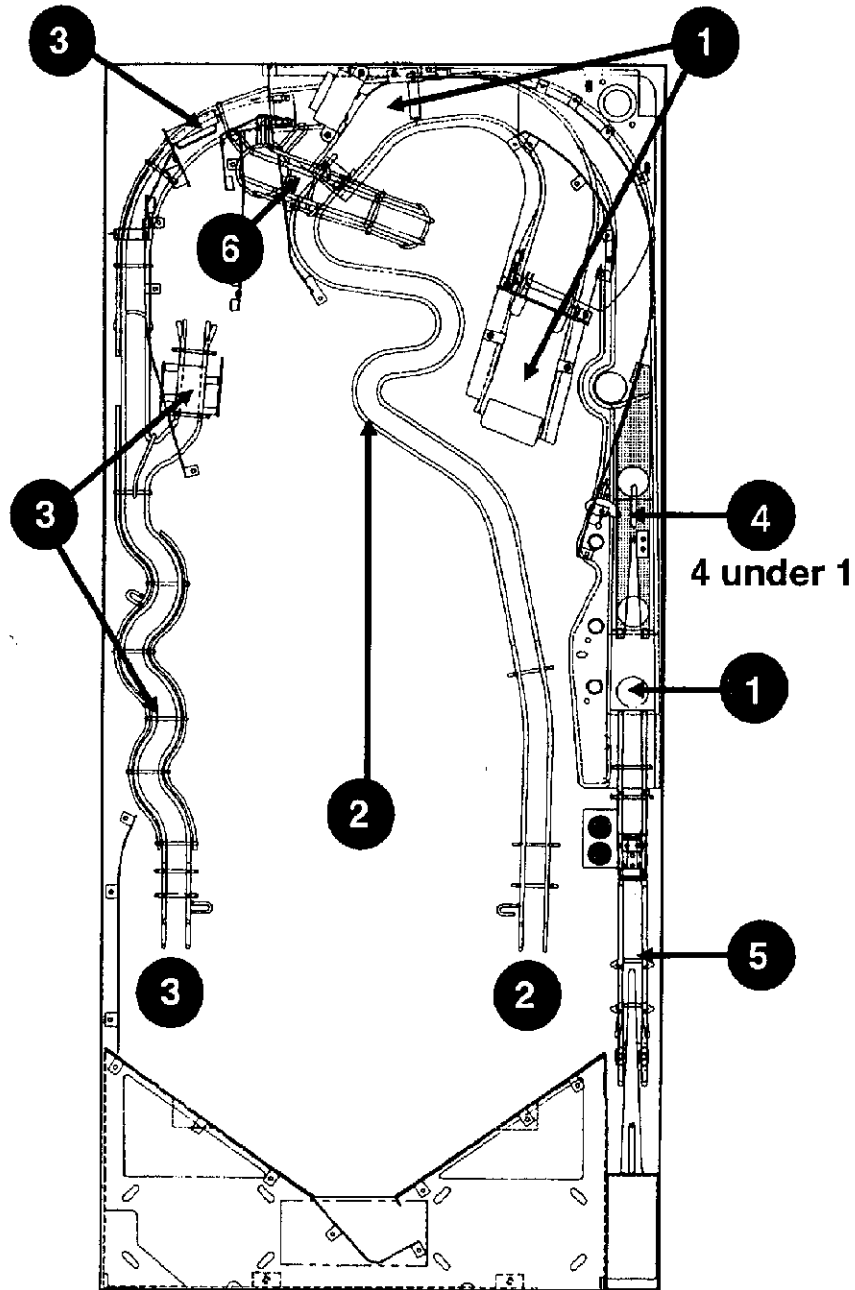

Item	Description	Part No.	Item	Description	Part No.
1 †	Right Plastic Ramp Assembly †	500-5883-01	5	Shooter Lane Wire Ramp Ass'y	500-5895-00
2	Right Return Wire Ramp	535-6253-00	5A	Shooter Lane Wire Ramp	515-6106-01
3 †	Left Return Wire Ramp Assy. †	500-5884-00	5B	Snap-In Minimars Red (Qty. 2)	550-5030-02
4	Skill Shot Flat Ramp Assy.	500-5885-00	5C	Clear Butyrate Around Lights	830-5466-32
4A	Skill Shot Flat Ramp	515-6145-00	5D	Mini-Foam Pad Hold Down .04"	626-5001-00
4B	Microswitch	180-5126-00	5E	Clear Butyrate Small	830-5466-29
4C	Diode 1N4001	112-5001-00	5F	#6 3/8 Hex-W AB Screws (Qty. 2)	234-5000-00
4D	#2-56 5/8 HWHS Screws (Qty. 2)	237-5917-00	6	VUK Exit Wire Ramp	535-6299-01

† See Unique Parts for Ramp Assembly Breakdowns.

PLAYFIELD - TOP PARTS (LOCATIONS)

(See Tables on next page for descriptions/part numbers)

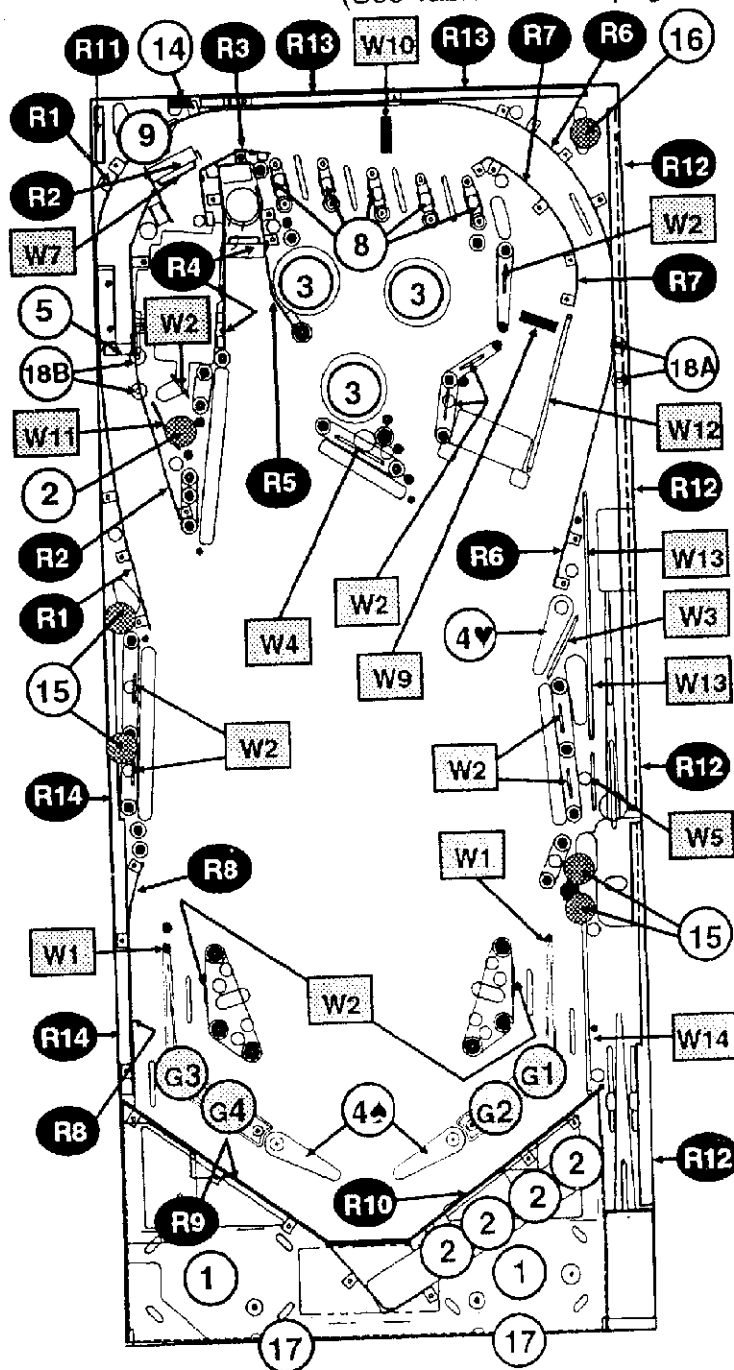

Ramps are not shown on drawing for clarity. See Playfield - Ramps (pg. 41) & Unique Parts (pgs. 64-67) for other Top Parts on the ramps.

#	General Parts
#	Painted Butyrate Pieces
#	Clear Butyrate Pieces
R#	All Rails (Flat, Wood, & Steel)
G#	All Ball Guides (Plastic & Metal)
W#	All Wire Forms (Metal)

Butyrate Notes:

The butyrate complete sheet PN is 830-546. Below are the individual locations for the pieces.

Not Shown:

Item -15 is the Narrow Backpanel Butyrate
 Item -16 is the Wider Backpanel Butyrate
 Item -17 is the Key Chain
 Item -18 is the Backbox Header

Clear Pieces (Unnumbered):

Item -34 is over item -12
 Item -33 (Small) is over item -07
 Item -35 is over item -08

Riveted Butyrate Assemblies:

Item -05 & Item -06 have 2 lights/sockets riveted to the butyrate. The part number to order if Butyrate with lights / sockets is required are listed below under the item number.

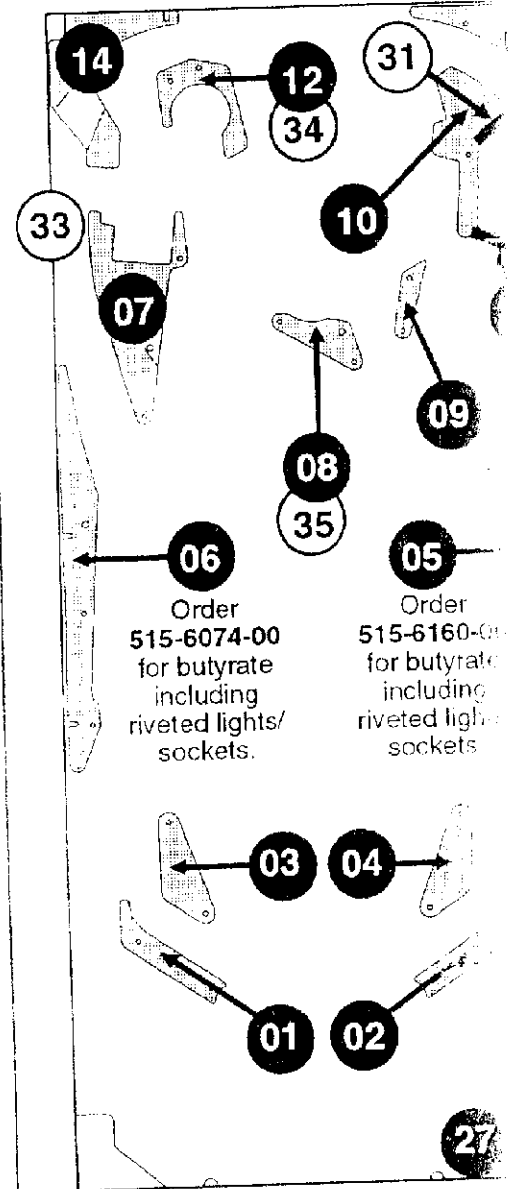

PLAYFIELD - TOP PARTS (TABLES)

(See diagrams on previous page for locations, except for items noted with an asterisk*)

Item	Description	Part No.	Item	Description	Part No.
1	Bottom Arch Assembly (Metal)	500-5861-01	16	Mini-Mars Light Cover Yellow	550-5031-06
2	1-1/16" Steel Balls, 1-Captive, 4-Play (5 Total)	260-5000-00	17	Playfield Hanging Bracket X2	535-5216-03
3	Pop Bumper Cap (Clear) X3	550-5057-01	18A	Pivot Pin Bracket Ass'y Right	500-5329-00
4♠	Flipper & Shaft Ass'y White ♠ X2	515-5133-01-01	18B	Pivot Pin Bracket Ass'y Left	500-5329-01
4♥	Flipper & Shaft Ass'y White ♥ X1	515-5133-01-02		Both Incl. Pivot Brkt. Screws X4 and T-Nut X4	237-5907-00 240-5101-00
5*	Left Orbit Switch Gate	See Flat Rails	19*	Stay Arm Holder	535-5747-00
6*	1-Way Gate to Paddle Wheel	See Flat Rails	20*	Plastic Riverboat	545-5539-02
7*	1-Way Gate to VUK	See Flat Rails			
8	Lite Hood Top Lanes Yellow X5	550-5036-06		Desc.: Butyrate	Part No.
9	Spot Lite & Bracket Ass'y X1	500-5893-00		P/F Butyrate Pieces † (1-34)	830-5466-XX
10*	Lite Deflectors on Ramps X2	518-5026-11	† To order replacement Butyrate, fill in the last 2 #'s with the corresponding # printed on each piece. For Clear Butyrate, describe location. Please view the location diagram for butyrate on the previous page.		
11*	Lite Cvr. Red Enter Ramp	545-5014-02	See Playfield - Ramps (pg. 41) or Unique Parts (pgs. 66 & 67) for Clear Butyrate attached to ramps.		
12*	Lite Cvr. Yellow Skill Shots X3	545-5014-06			
13*	Lite Cvr. Flo. Org. Enter Ramp	545-5014-10			
14	Mini-Mars Lite Cvr. Flo. Org.	550-5031-10			
15	Mini-Mars Lite Cvr. Snap Red X4	550-5030-02			

Item	Desc.: Mylar	Part No.
M1*	Mylar Pieces (Clear Pre-Scored)	820-5841-00
M2*	Mylar Pad (Clear : 1" Sq.) X3	820-5815-00
M3*	Front of Slingshot Clear Mylar	820-5821-00
Item	Desc.: Decals	Part No.
D1*	Decal Sheet for Arch & Bumpers	820-6108-XX
D2*	Decals for 3-Bank Drops	820-6110-01
D3*	Decals for 4-Bank Drops	820-6110-02
D4*	Decals for 5-Bank Upr. Drops	820-6110-03
D5*	Decals for 5-Bank Lwr. Drops	820-6110-04
Item	Desc.: Rails (R)	Part No.
R1	Flat Rail Outer Left Orbit	535-6231-01
R2	Flat Rail Inner Lt. Orbit w/Gate & Paddle Wheel Gate Riveted	500-5904-00
R3	Flat Rail Behind VUK w/OPTO	515-6117-01
R4	Flat Rail to VUK Left with VUK Gate Riveted	515-6173-00
R5	Flat Rail to VUK Right	535-6250-01
R6	Flat Rail Outer Right Orbit	535-6232-01
R7	Flat Rail Inner Right Orbit	535-6230-01
R8	Flat Rail Left Outlane	535-6237-01
R9	Flat Rail Bottom Arch Left	535-6240-01
R10	Flat Rail Bottom Arch Right	535-6239-01
R11	Steel Rail Mini Upr. Left Corner	535-7097-00
R12	Steel Rail Playfield Right	535-6265-01
R13	Wood Rail 15" Top of Playfield	525-5007-12
R14	Wood Rail Bottom Left Playfield	525-5376-00

Item	Desc.: Ball Guides (G)	Part No.
G1	Ball Guide Upper Right Return	550-5043-01
G2	Ball Guide Lower Right Return	550-5037-01
G3	Ball Guide Upper Left Return	550-5038-01
G4	Ball Guide Lower Left Return	550-5064-01

Item	Desc.: Wire Forms (W)	Part No.
W1	Wire Form on Ball Guides X2	535-5642-00
W2	Wire Form 1" X10	535-5300-05
W3	Wire Form 2.5" (Upr. Flipper)	535-5300-01
W4	Wire Form 2" ø .120 (3-Bank)	535-5356-01
W5	Wire Form 2" ø .090 (4-Bank)	535-5300-10
W6	Wire Form on Left Orbit Gate	535-7078-00
W7	Wire Form on Paddle Wheel Gate	535-7087-01
W8	Wire Form on VUK Gate	535-7112-00
W9	Wire Form on Ramp Enter Gate	535-7163-00
W10	Wire Form on Ramp Exit Gate	535-6304-00
W11	Wire Form 2.75" Upr. 5-Bank	535-6492-02
W12	Wire Form 5.75" Inner Rt. Orbit	535-6492-12
W13	Wire Form 8.844" Shooter Lane	535-6546-01
W14	Wire Form 6.75" Right Outlane	535-6992-05
*	Snubbers Lwr. Flip. (Not Used)	535-5373-01

Page	Desc.: Other Part Numbers
44	Rubber Parts
45	Posts
46	Lamps with Sockets
47	Lamps with Sockets & Lamp Boards
See Table of Contents to find any other parts.	

PLAYFIELD - RUBBER PARTS

A
Item A is located on the Knocker, Skill Launch, VUK, and Laser Kick Back.

B
Item B locations are not shown to maintain clarity in this diagram. An example of item B is located under item E at left outline.

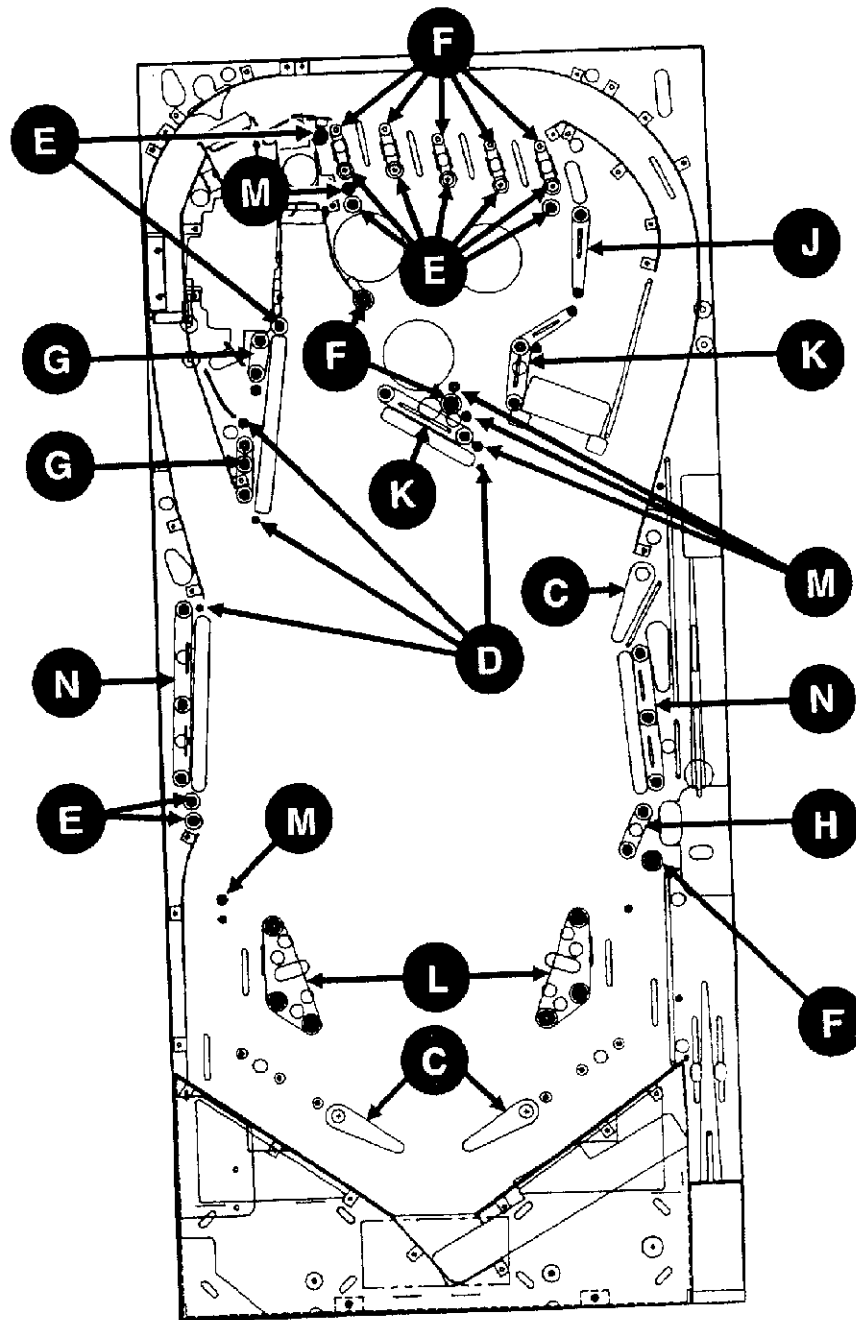

Item	Description	Qty.	Part No.	Item	Description	Qty.	Part No.
A	Rubber Bumper	4	545-5105-00	†	1-1/4" I.D. Black Rubber Ring	0	545-5348-05
B	Post Rubber (Sleeve Short)	24	545-5151-00	J	1-1/2" I.D. Black Rubber Ring	1	545-5348-01
†	Flipper Bushing (Small)	0	545-5192-00	K	2" I.D. Black Rubber Ring	2	545-5348-02
C	Flipper Rubber Rings	3	545-5277-00	L	2-1/2" I.D. Black Rubber Ring	2	545-5348-03
D	Post Rubber (Sleeve Tall)	4	545-5308-00	M	3/8" O.D. Black Rubber Ring	5	545-5348-04
E	3/16" I.D. Black Rubber Ring	11	545-5348-01	†	Bumper Post Rubber	0	545-5348-05
F	5/16" I.D. Black Rubber Ring	8	545-5348-02	N	2-3/4" I.D. Black Rubber Ring	2	545-5348-06
G	3/4" I.D. Black Rubber Ring	2	545-5348-04	†	1-3/4" I.D. Black Rubber Ring	0	545-5348-07
H	1" I.D. Black Rubber Ring	1	545-5348-05				

Please note, the size and/or quantities may change as production continues.

PLAYFIELD - POSTS

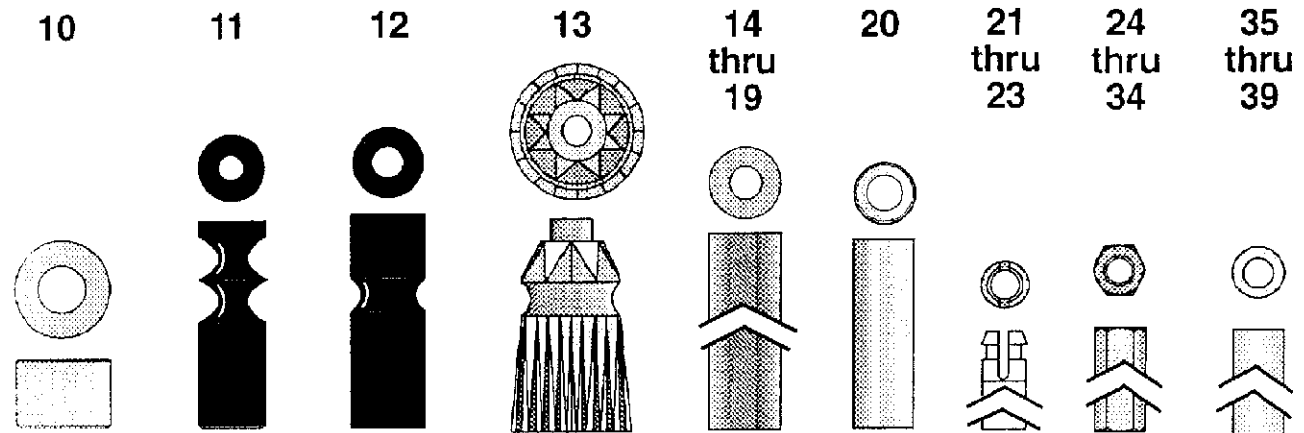
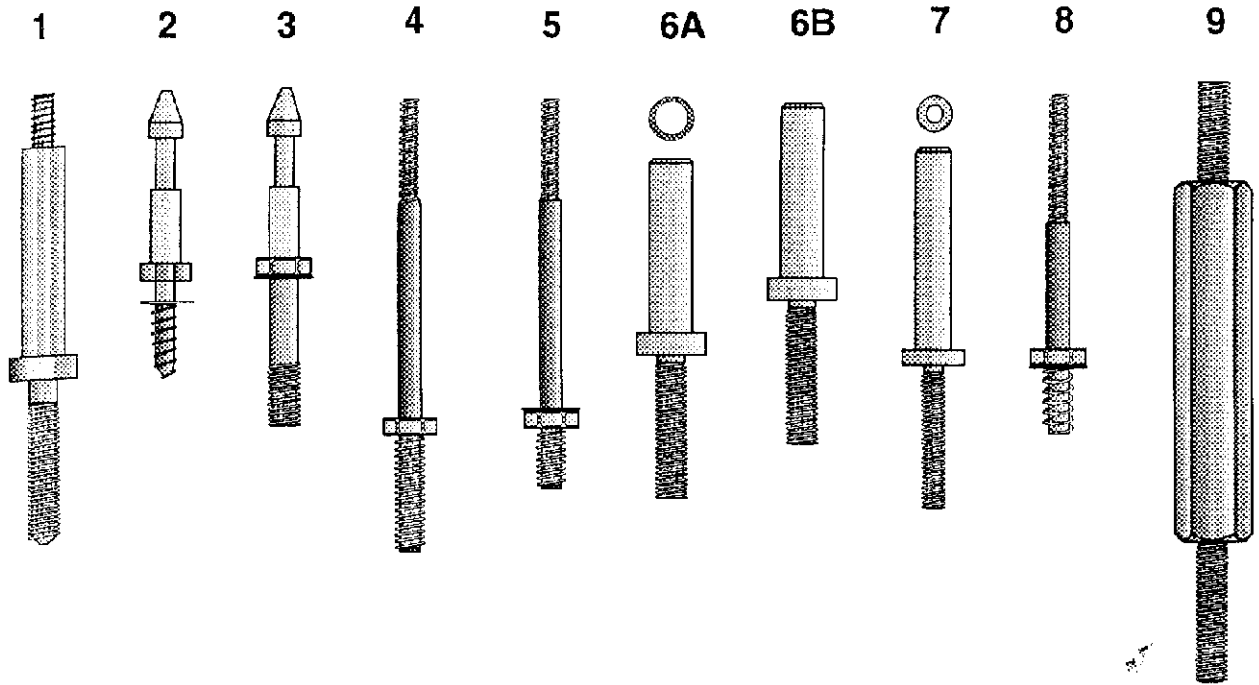

Item	Description	Qty.	Part No.	Item	Description	Qty.	Part No.
1	BUMPER POST - MACHINE	0	530-5007-00	20	Spcr. 1" Lg Metal 5/16" X .144ID	0	254-5001-00
2	MINI-POST-WOOD THD	4	530-5004-00	21	Spcr. 3/8" Plstc. Slf. Rtn. SRS6-6-01	26	254-5007-01
3	MINI-POST-MACHINE THD	4	530-5005-00	22	Spcr. 1/4" Plstc. Slf. Rtn. SRS6-4-01	4	254-5007-02
4	MACH. POST SCREW LG.	7	530-5008-00	23	Spcr. 3/4" Plstc. Slf. Rtn. SRS6-12-01	0	254-5007-03
5	POST MACHINE SCREW	18	530-5012-02	24	Spacer 1/4" Hex Tapped 6-32	0	254-5008-00
6A	BUMPER POST 8-32 TAP.	0	530-5075-00	25	Spacer 1/2" Hex Tapped 6-32	1	254-5008-03
6B	BUMPER POST UNTAPPED	5	530-5057-01	26	Spacer 5/8" Hex Tapped 6-32	3	254-5008-02
7	BUMPER POST 6-32 TAP.	0	530-5127-00	27	Spacer 3/4" Hex Tapped 6-32	3	254-5008-04
8	POST MACHINE SCREW	0	530-5263-01	28	Spacer 1" Hex Tapped 6-32	2	254-5008-06
9	MINI-PLAYFIELD SUPPORT	0	530-5285-00	29	Spacer 2" Hex Tapped 6-32	6	254-5008-07
10	SPACER BACKBOX HINGE	2	530-5099-00	30	Spacer 2 3/4" Hex Tapped 6-32	1	254-5008-08
11	STAND-OFF 2 GRV. 1-1/16"	0	530-5102-01	31	Spacer 1 1/2" Hex Tap. 6-32	1	254-5008-09
12	PLASTIC POST (GRY)	28	550-5059-00	32	Spacer 1 1/4" Hex Tap. 6-32	0	254-5008-11
13	SML. JEWEL POST (CLR)	3	550-5034-01	33	Spacer 2 3/4" Hex Tap. 6-32	0	254-5008-12
	SML. JEWEL POST (GRN)	9	550-5034-04	34	Spacer 1 7/8" Hex Tap. 6-32	1	254-5008-20
14	SPCR. 1/2" PLSTC. (BLK) 3/8"	2	254-5000-01	35	Spcr. 1/2" Lg. X 5/16" X .144ID	3	254-5014-00
15	SPCR. 1/2" PLSTC. Nar. 3/8"	1	254-5000-03	36	Spcr. 3/4" Lg. X 5/16" X .144ID	0	254-5014-01
16	SPCR. 1" PLSTC. 3/8"	2	254-5000-04	37	Spcr. 1.13" Lg. X 5/16" X .144ID	6	254-5014-02
17	SPCR. 1 1/4" PLSTC. 3/8"	0	254-5000-05	38	Spcr. 1/4" Lg. X 5/16" X .144ID	4	254-5014-03
18	SPCR. 1 1/8" PLSTC. 3/8"	1	254-5000-06	39	Spcr. 9/16" Lg. X 5/16" X .144ID	3	254-5014-04
19	SPCR. 3/4" PLSTC. 3/8"	3	254-5000-07	† Items with a zero Qty. are not used in this game.			

Please note, the size and/or quantities may change as production continues.

PLAYFIELD - LAMPS WITH SOCKETS

Item	Description (1 bulb per socket)	Qty.	Part No.	Item	Description (1bulb per socket)	Qty.	Part N
A	#44 Bulb	80	165-5000-44	8A	2-Lug Stand-Up Long Socket	2	077-500
1A	2-Lug Staple Down Socket	56	077-5000-00	9A	1-Lug Stand-Up Long Socket	3	077-501
2A	2-Lug Stand-Up Short Socket	0	077-5002-00	B	#89 Bulb	29	165-500
3A	3-Lug Stand-Up Short Socket	0	077-5008-00	1B	Laydown Standard Socket	1	077-510
4A	3-Lug Laydown Socket	9	077-5006-00	2B	Stand-Up, Short Socket	17	077-510
5A	2-Lug Laydown Socket	1	077-5003-00	3B	Stand-Up, Long Socket	7	077-510
6A	3-Lug Stand-Up Long Socket	10	077-5009-00	4B	S-U, Socket Rev. Short	4	077-510
7A	3-Lug Staple Down Socket	0	077-5001-00	5B	Straight Leg Socket	0	077-510

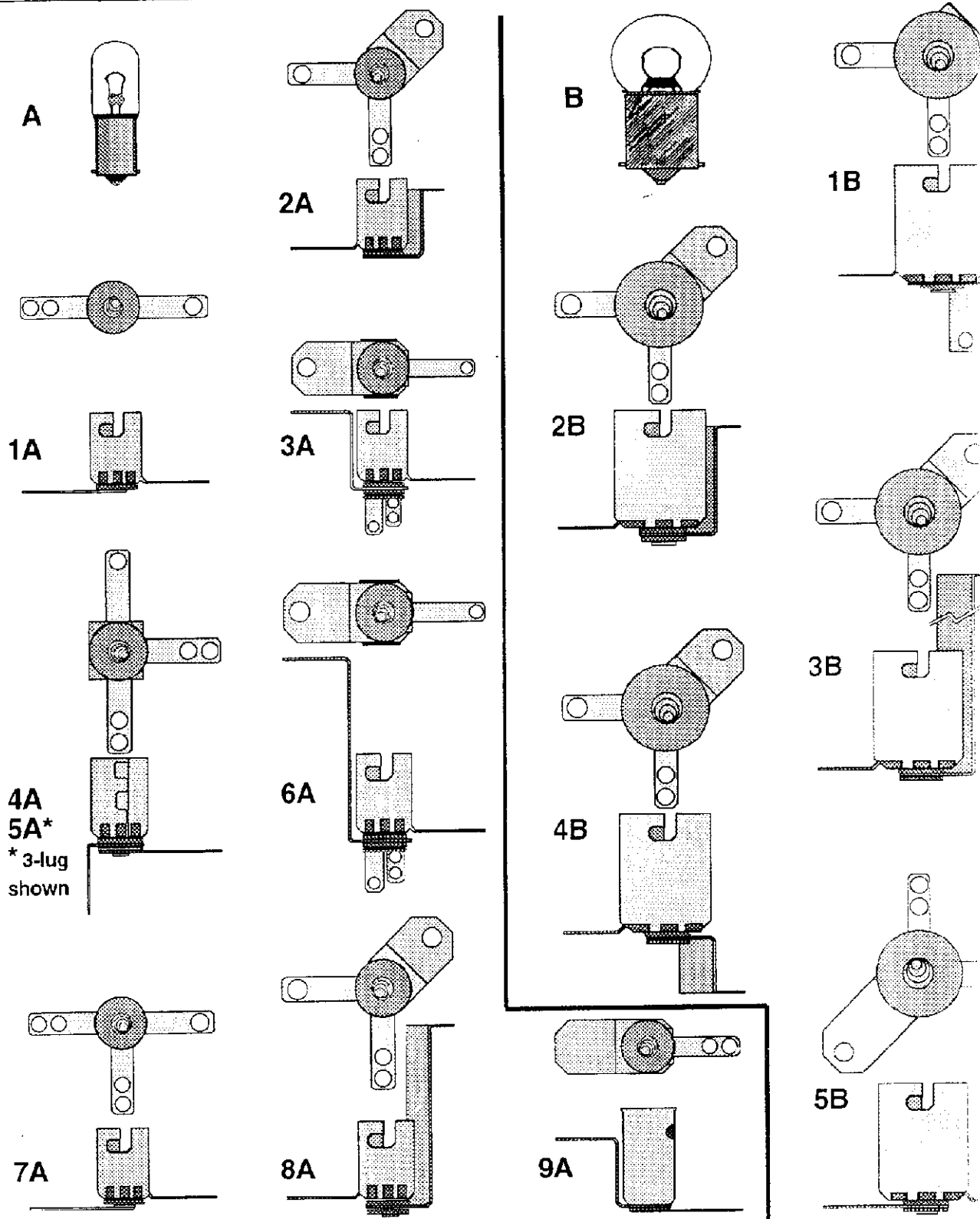

4A
5A*
* 3-lug
shown

PLAYFIELD - LAMPS WITH SOCKETS

Item	Description (1 bulb per socket)	Qty.	Part No.
D	#555 Wedge Base Bulb *	48	165-5002-00
1D	555 Wedge Base Socket **	34	077-5007-00
2D	Laydown Wedge Base L/R BLK	4	077-5026-01
3D	Wedge Offset Bracket Socket	5	077-5029-00
4D	Laydown Wedge Base Black	0	077-5026-00
E	#906 Wedge Base Bulb	5	165-5004-00
1E	906 Wedge Base Socket	0	077-5016-00

* 3 extra #555 Bulb located 1 per Pop Bumper.

Item	Lamp Board P.N.	Item	Lamp Board P.N.
A	520-5093-01	E	520-5079-05
B	520-5093-02	F	520-5079-06
C	520-5093-03	G	520-5079-07
D	520-5093-04		

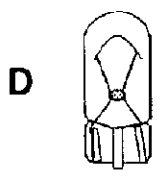

D

Note the notch in the bracket. (Used with Reflectors.)

** This socket used only on Lamp Bds.



1D

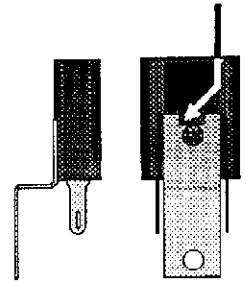

2D

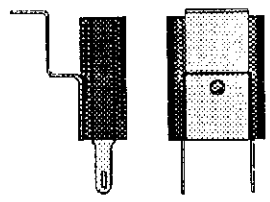

3D

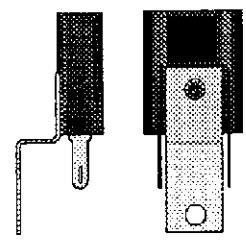

4D

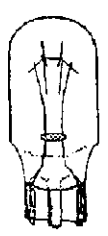

E

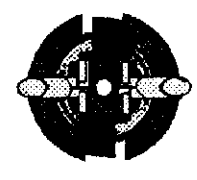

1E

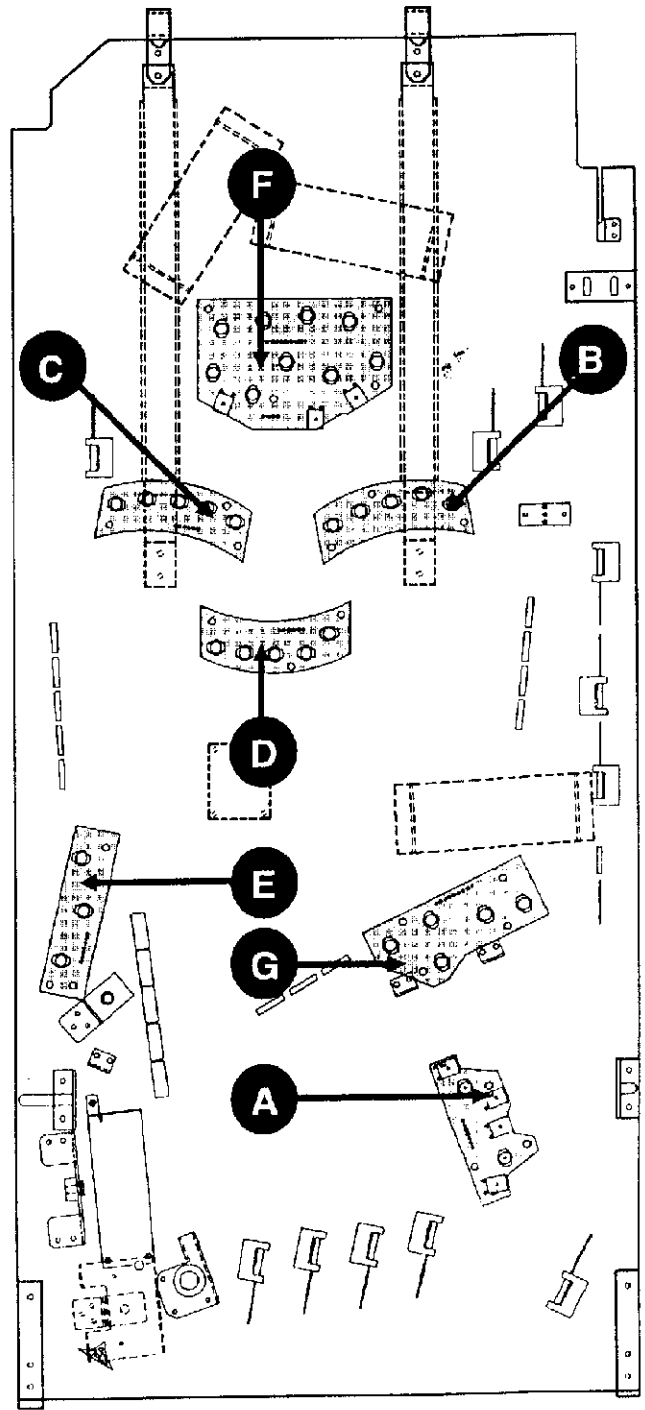

UNDER PLAYFIELD: BOTTOM VIEW