



WELLS-GARDNER ELECTRONICS CORPORATION

19" IN-LINE COLOR MONITORS

MODELS

- 19 K4601
- 19 K4602
- 19 K4603
- 19 K4604
- 19 K4653

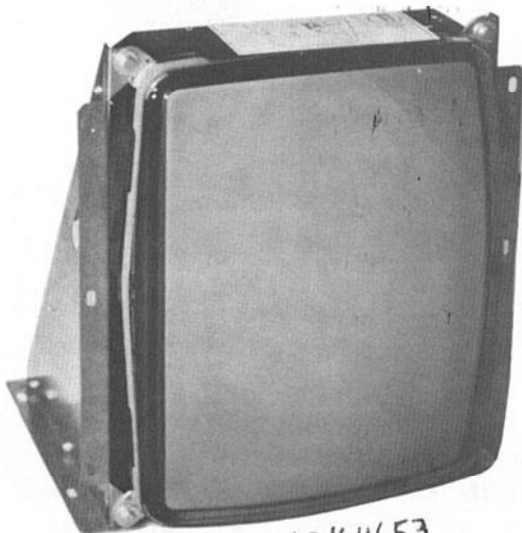
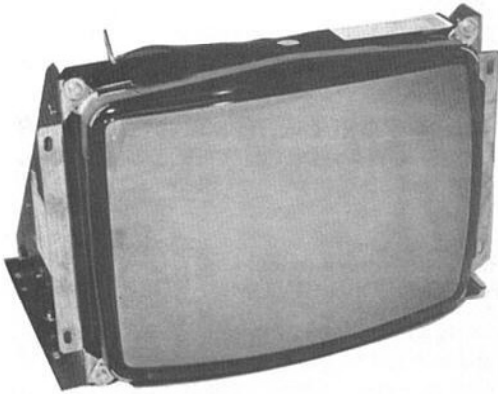

19K4653

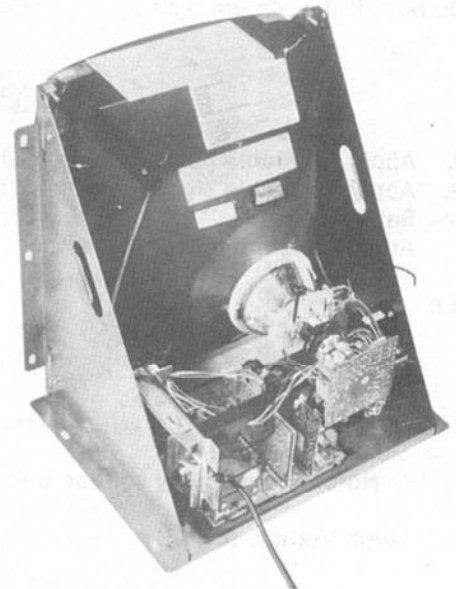

**WELLS-GARDNER ELECTRONICS
CORPORATION**

2701 NORTH KILDARE AVENUE
CHICAGO, ILLINOIS 60639

K4600 IMPORTANT SERVICE SAFETY INFORMATION

WARNING: An isolation transformer must be used between the AC supply and the AC plug of the monitor before servicing or testing is performed since the chassis and the heat-sink are directly connected to one side of the AC line which could present a shock hazard.

The chassis of the monitor should never be connected to the ground. Before servicing is performed, read all the precautions labelled on the CRT and chassis.

X-RAY RADIATION WARNING NOTICE

WARNING: PARTS WHICH INFLUENCE X-RAY RADIATION IN HORIZONTAL DEFLECTION, HIGH VOLTAGE CIRCUITS AND PICTURE TUBE ETC. ARE INDICATED BY (★) IN THE PARTS LIST FOR REPLACEMENT PURPOSES. USE ONLY THE TYPE SHOWN IN THE PARTS LIST.

PRODUCT SAFETY NOTICE

WARNING: FOR CONTINUED SAFETY REPLACE SAFETY CRITICAL COMPONENTS ONLY WITH MANUFACTURER RECOMMENDED PARTS. THESE PARTS ARE IDENTIFIED BY SHADING AND BY (Δ) ON THE SCHEMATIC DIAGRAM.

AVERTISSEMENT: POUR MAINTENIR LE DEGRE DE SECURITE DE L'APPAREIL NE REMPLACER LES COMPOSANTS DONT LE FONCTIONNEMENT EST CRITIQUE POUR LA SECURITE QUE PAR DES PIECES RECOMMANDEES PAR LE FABRICANT.

For replacement purposes, use the same type or specified type of wire and cable, ensuring that the positioning of the wires is followed (especially for H.V. and power supply circuits). Use of alternative wiring or positioning could result in damage to the monitor or in a shock or fire hazard.

The picture tube used, employs integral implosion protection and should be replaced with a tube of the same type number for continued safety.

When handling the CRT, shatter-proof goggles must be worn after completely discharging the high voltage circuit. Do not lift the picture tube by the neck.

PERFORMANCE AND OPERATING DATA

1. Apply a suitable power source to the monitor through an isolation transformer.
2. Apply a suitable signal source to the monitor PCB by means of P205.
3. Set up Controls.
All controls are preset at the factory, but may be adjusted to suit program material.

1.0 Supply

Voltage	108 VAC - 132 VAC
Frequency	50 Hz - 60 Hz

Note: Apply supply voltage through an isolation transformer with 1 Amp. capability.

2.0 High Voltage (EHT)

For 19"V models	25.5 ± 0.8 K.V. at 0 Beam
-----------------	---------------------------

Note: Condition for above 1 (beam) = 0
A.C. = 120V

3. Service Set-Up Controls

- A. V. Adjustment VR501 set for 127V DC
- B. Vertical Size Cont = VR302
- C. Vertical Hold Cont = VR301
- D. Horizontal Hold Cont = VR351
- E. Horizontal Width Cont = L702
- F. Focus Control = VR702

VERT. CENTERING
YELLOW LEAD
UP - CENTER - DOWN - CENTER

- G. Screen Control = VR406
- H. Video Drive Controls - Red Drive = VR401
Green Drive = VR402
- I. CRT Cut Off Controls - Red Cutoff = VR403
Green Cutoff = VR404
Blue Cutoff = VR405

HORIZ. CENTERING
RED LEAD
LEFT - CENTER - RIGHT

SERVICE INSTRUCTIONS

FOCUS

Adjust the Focus control (VR702), located on the HV unit (T701), for maximum over-all definition and fine picture detail.

+ 127V ADJUSTMENT (See Fig. 1)

The + 127V adj. control (VR501) is adjusted at the factory. However, if readjustment should be required, proceed as follows.

1. Operate monitor for at least 15 minutes at 120V AC line.
2. Connect Positive lead of V.T.V.M. to blue lead of TR502 emitter negative lead to chassis ground.
3. Adjust VR501 to obtain + 127V reading.
4. After adjustment VR501 must be locked with a sealing varnish.

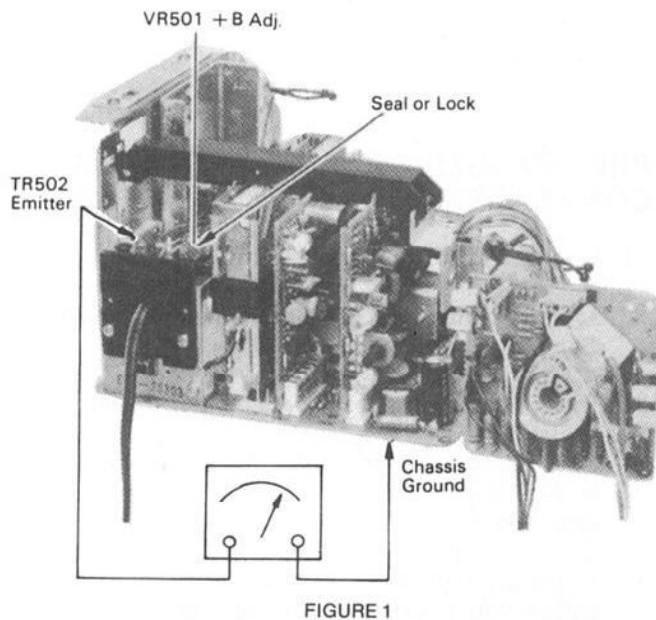

FIGURE 1

BLACK LEVEL CONTROL ADJUSTMENT

This control has been set at the factory and should not need further attention. If however when the game is connected a slight adjustment of VR201 may be necessary to obtain the proper black level (the black portion of the picture just extinguished).

VERTICAL SIZE (HEIGHT)

The vertical height control is a screw-driver adjustment. Location of this control is shown in Fig. 3. This control must be adjusted slowly, if necessary, until the picture or test pattern attains the correct vertical proportions.

CIRCUIT PROTECTION

A 3.0A pigtail fuse, mounted on the Main Board has been provided to protect the Power Output Circuit.

HORIZONTAL OSC. ALIGNMENT

(See Fig. 2)

A warm-up period of at least five minutes should be allowed before alignment is carried out. Set VR351 to center position.

Adjust L351 after grounding R328 plug. (TP32 of Vert/ Horiz. P.C. Board) through a 1uF/50V capacitor. Adjust L351 to obtain normal picture.

After adjustment, remove 1uF/50V capacitor.

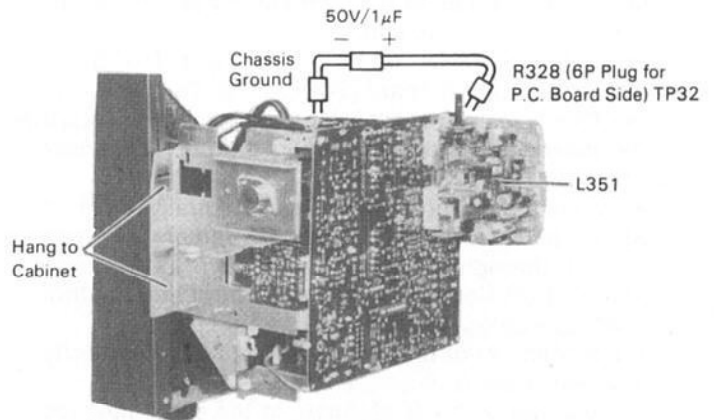

FIGURE 2

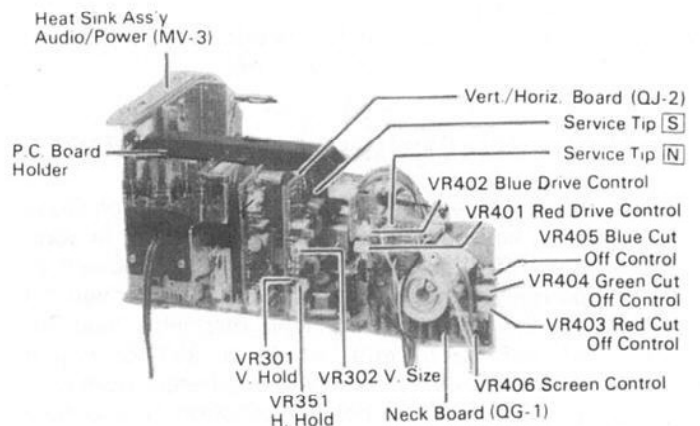

FIGURE 3

INSTALLATION AND SERVICE INSTRUCTIONS

COLOR PURITY AND VERTICAL CENTERING ADJUSTMENT

For best results, it is recommended that the purity adjustment be made in the final monitor location. If the monitor will be moved, perform this adjustment with it facing west or east. The monitor must have been operating 15 minutes prior to this procedure and the faceplate of the CRT must be at room temperature.

The monitor is equipped with an automatic degaussing circuit. However, if the CRT shadow mask has become excessively magnetized, it may be necessary to degauss it with manual coil. Do not switch the coil OFF while the raster shows any effect from the coil.

Purity Magnets are used for Color Purity and V Centering Adjustment.

Purity Adjustment procedure is as follows.

1. Remove R-G-B signal from monitor.
2. Turn Green Cut off Control (VR404) on the Neck Board fully CCW.
Turn Red and Blue Cut off Control (VR405) fully CW.
3. Pull the Deflection Yoke backward so that the Magenta belt will appear. (See Fig. 4)
4. Move the two Purity Magnets and bring the Magenta belt to the mechanical center of the screen (See Fig. 5) The vertical center position should be set VRS to $-5/64$ " (-2 mm) as shown in Fig. 6.
Insert service tip "N" on Neck circuit board to "S" on Vert./Horiz. circuit board (See Fig. 13). To check, use the Green raster at low intensity. Be sure to return the service tips to their original positions for the next check.
5. Push the Deflection Yoke forward gradually and fix it at the place where the Magenta screen becomes uniform throughout.
6. Turn Cut off Control, and Drive Control and confirm that each color is uniform.
7. If the color is not uniform, re-adjust it moving Purity Magnets slightly.
8. Move a pair of Purity Magnets at the same time (do not change the angle of the pair), and adjust the vert. center to center of screen.
9. Obtain the three colors and confirm whether white uniformity is balanced.
10. Insert the temporary wedge as shown in Fig. 5 and adjust the angle of Deflection Yoke.

STATIC CONVERGENCE ADJUSTMENT

A recently developed Deflection Yoke and Electron Guns construction has been used on this equipment in combination with In-Line Guns and Black Stripe Screen to make a barrel-type magnetic-field distribution for vertical deflection and a pin-cushion-type magnetic field for horizontal deflection with which a self-converging system can be obtained. This type is different from conventional unity-magnetic field distribution type deflection yoke. 4-Pole Magnets and 6-Pole Magnets are

employed for static convergence instead of a Convergence Yoke.

1. A cross hatch signal should be connected to the monitor.
2. A pair of 4-Pole Convergence Magnets are provided and adjusted to converge the blue and red beams. When the Pole opens to the left and right 45° symmetrically, the magnetic field maximizes. Red and blue beams move to the left and right oppositely (See Fig. 7-a and 7-b). Variation of the angle between the tabs adjusts the convergence of red and blue vertical lines.
When the both 4-Pole Convergence Magnet Tabs are rotated as a pair, the convergence of the red and blue horizontal lines is adjusted.
3. A pair of 6-Pole Convergence Magnets are also provided and adjusted to converge the magenta (red + blue) to green beams.
When the Pole opens to the left and right 30° symmetrically, the magnetic field is maximized. Red and blue beams both move to the left and right (See Fig. 8-c and 8-d).
Variation of the opening angle adjusts the convergence of magenta to green vertical lines. When both 6-Pole Convergence Magnet Tabs are rotated as a pair the convergence of magenta to green horizontal lines is adjusted.

PRECISE ADJUSTMENT OF DYNAMIC CONVERGENCE (See Fig. 10 and 11)

1. Feed a cross hatch signal to the monitor.
2. Insert the temporary wedge and fix Deflection Yoke so as to obtain the best circumference convergence (See Fig. 10 and 11).
NOTE:
The temporary wedges may need to be moved during adjustments.
4. Insert three rubber wedges to the position as shown in Fig. 9 to obtain the best circumference convergence.

NOTE:

- 1) Tilting the angle of the yoke up and down adjusts the crossover of both vertical and horizontal red and blue lines. See Fig. 10 (a) and (b).
- 2) Tilting the angle of the yoke sideways adjusts the parallel convergence of both horizontal and vertical lines at the edges of the screen. See Fig. 11-a and b.
- 3) Use three rubber wedges (thick and thin rubber wedges are used for a purpose).
- 4) The angle of each rubber wedges are shown in Fig. 9.
- 5) After three rubber wedges have been inserted, pull out the temporary wedge.
- 6) Fix the rubber wedges with chloroprene rubber adhesive.

INSTALLATION AND SERVICE INSTRUCTIONS

BLACK AND WHITE TRACKING (With R/G.B. inputs grounded)

1. Set Black Level Control (VR201) to mid point.
2. Set Red and Blue Drive Controls (VR401 & VR402) to their mechanical center.
3. Set the G2 Screen Control (VR406) and the 3 Cut-off Controls (VR403, VR404, & VR405) to minimum

(CCW).

4. Slowly turn up G2 screen control until the first faint color appears.
5. Slowly turn up the other two color cut-off controls in turn to match the first.
6. Remove ground from R/G/B/ inputs. Adjust Red and Blue Drive Controls (VR401 & VR402) for white screen.

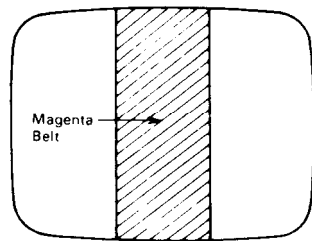

FIGURE 4

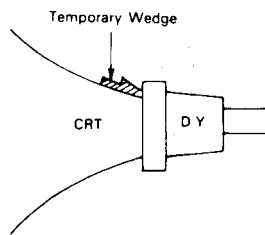

FIGURE 5

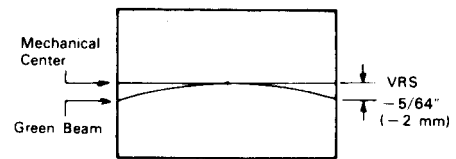
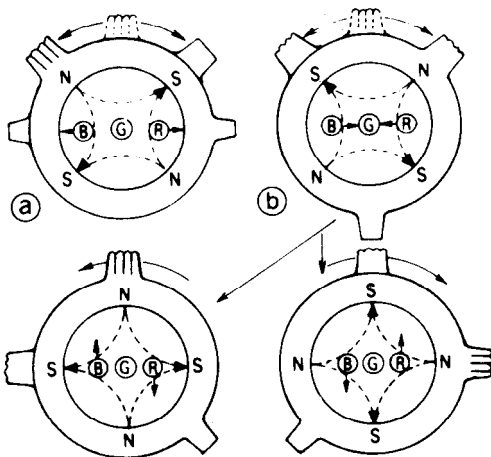
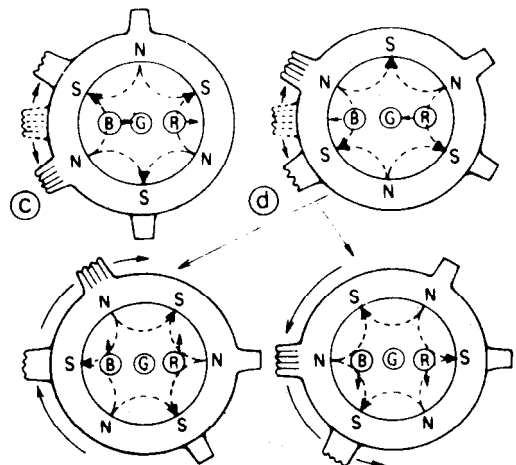

FIGURE 6



4-Pole Magnets and the Movement of Beams

FIGURE 7



6-Pole Magnets and the Movement of Beams

FIGURE 8

INSTALLATION AND SERVICE INSTRUCTIONS

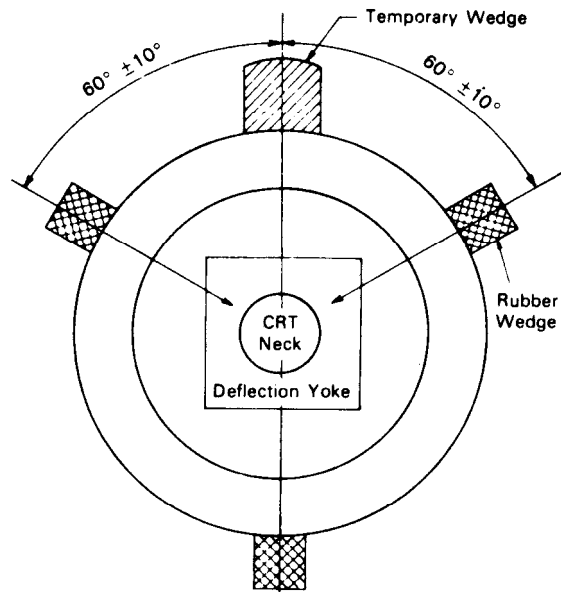
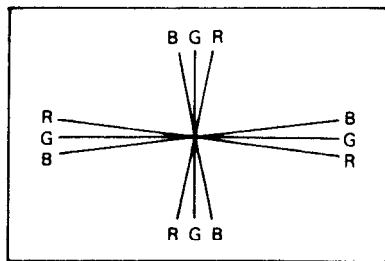
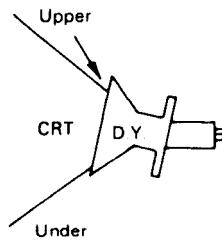

FIGURE 9



CRT Screen

(a)



Insert Rubber Wedge from Upper Side

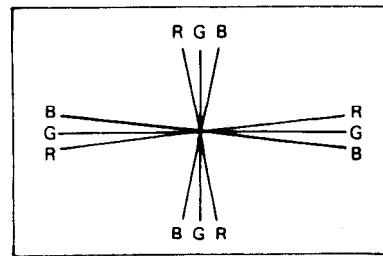

CRT Screen

(b)

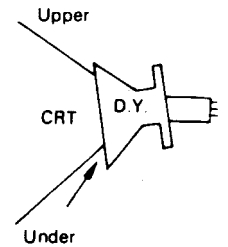

Insert Rubber Wedge from Lower Side

FIGURE 10

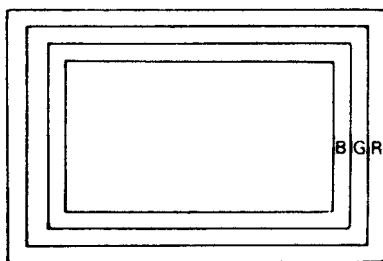

CRT Screen

(a)

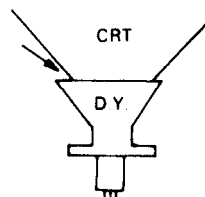

Insert Rubber Wedge from Left Side

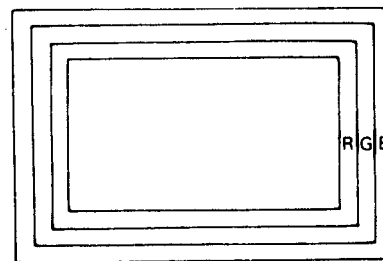

CRT Screen

(b)

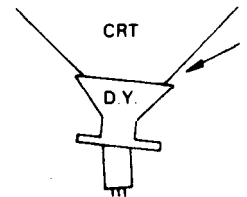

Insert Rubber Wedge from Lower Side

FIGURE 11

INSTALLATION AND SERVICE INSTRUCTIONS

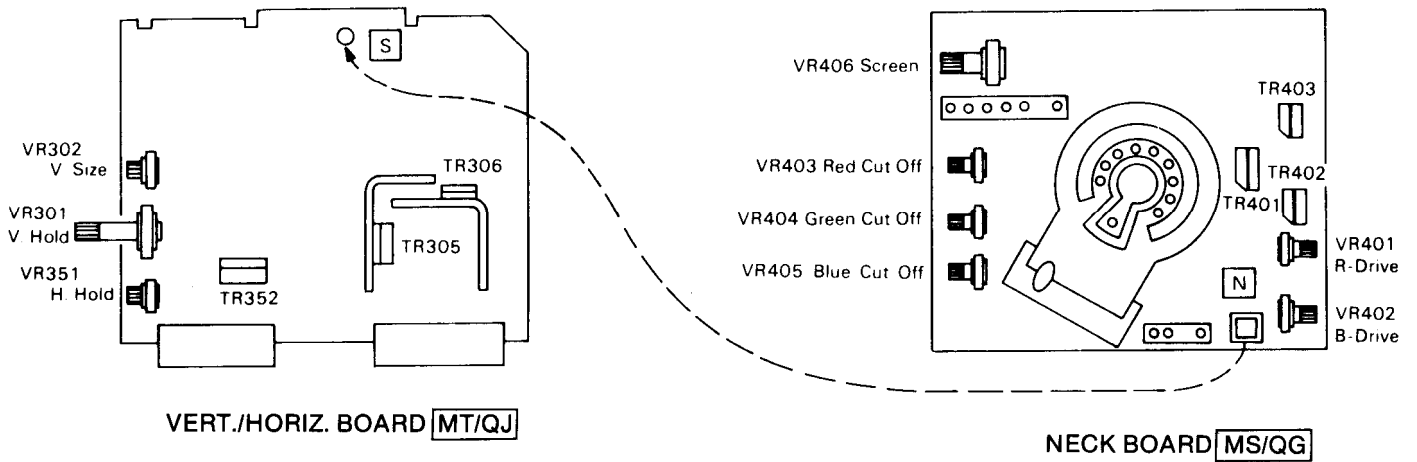

FIGURE 12

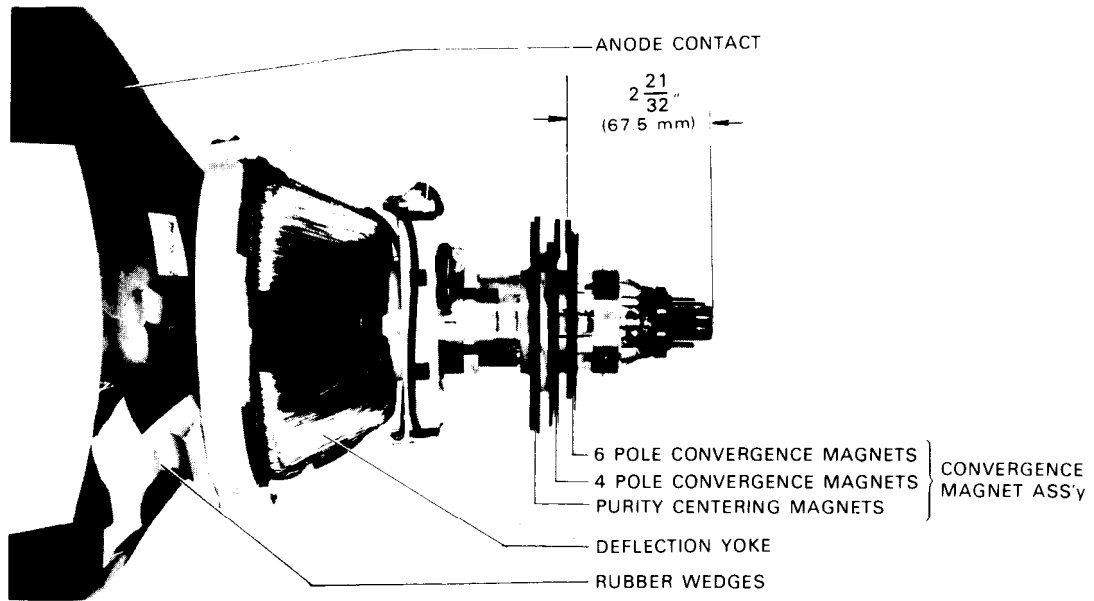

FIGURE 13. PICTURE TUBE NECK COMPONENTS LOCATION

P.C. BOARD LAYOUT

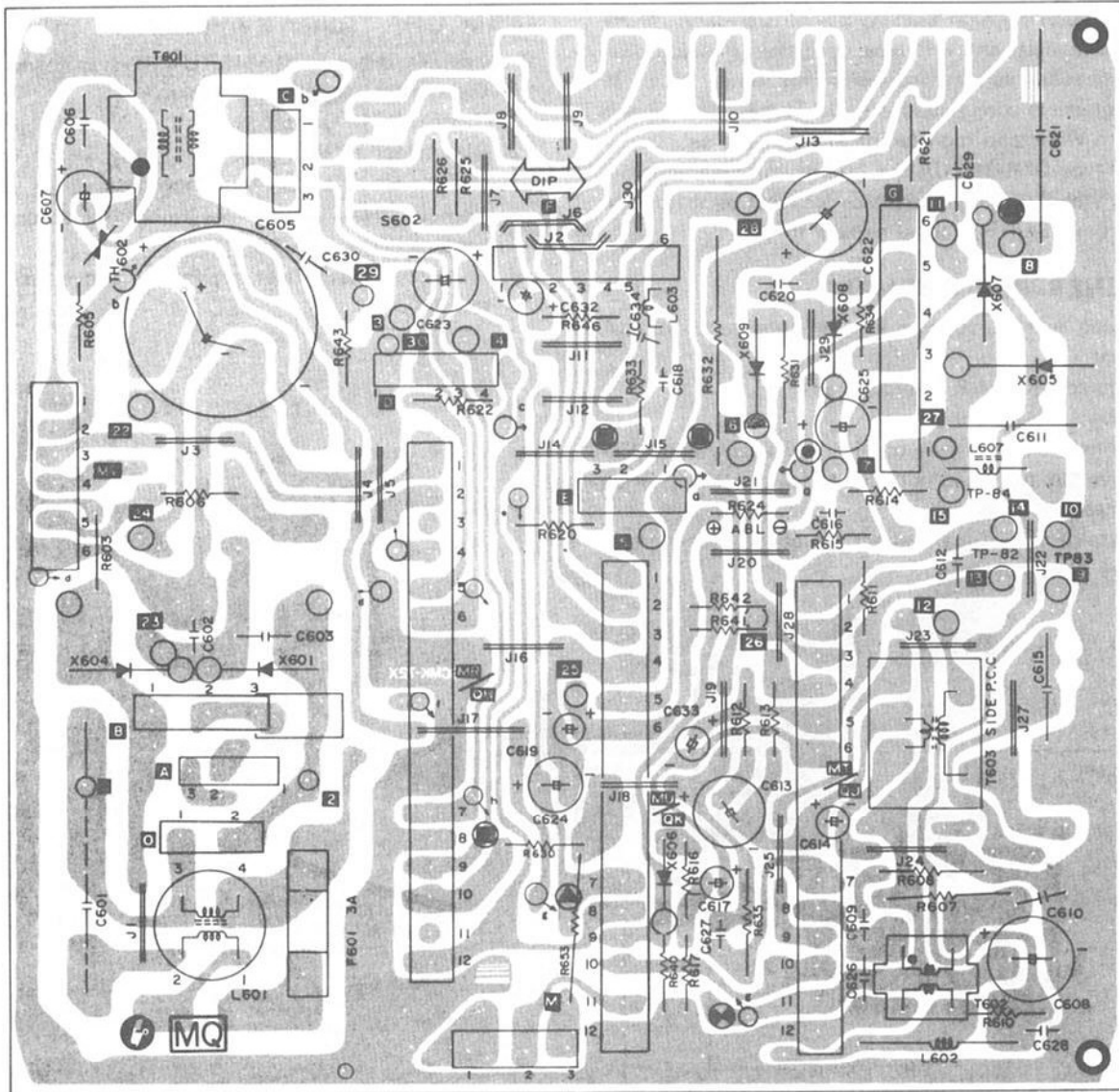

FIGURE 14. MAIN P.C. BOARD MQ-29

P.C. BOARD LAYOUT

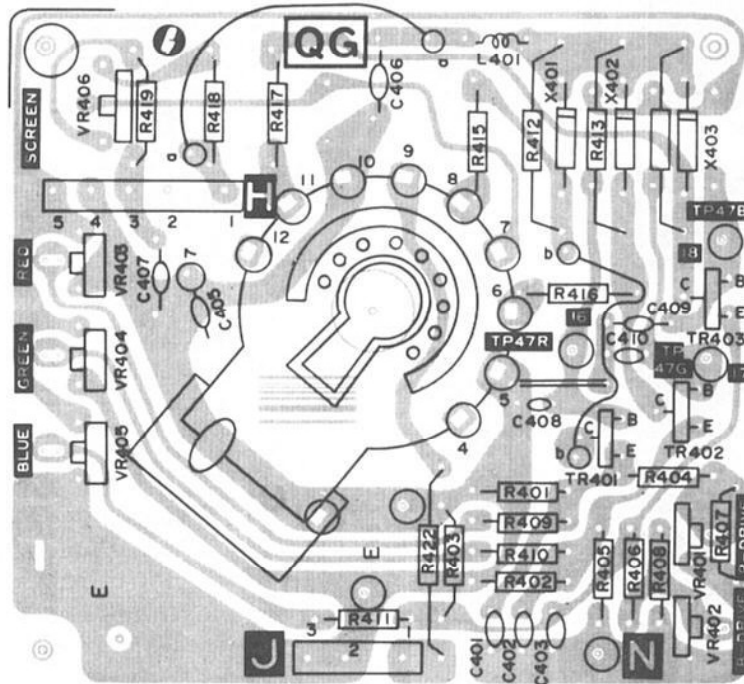

FIGURE 15. NECK P.C. BOARD MS/QG

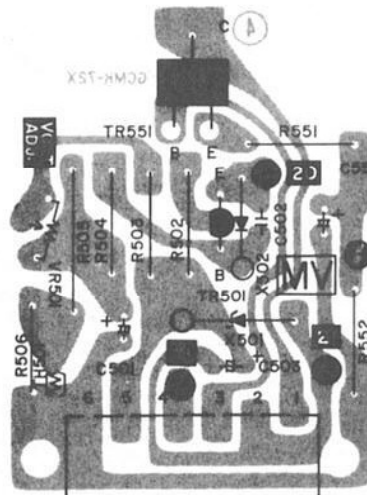

FIGURE 16. POWER PC BOARD MV

P.C. BOARD LAYOUT

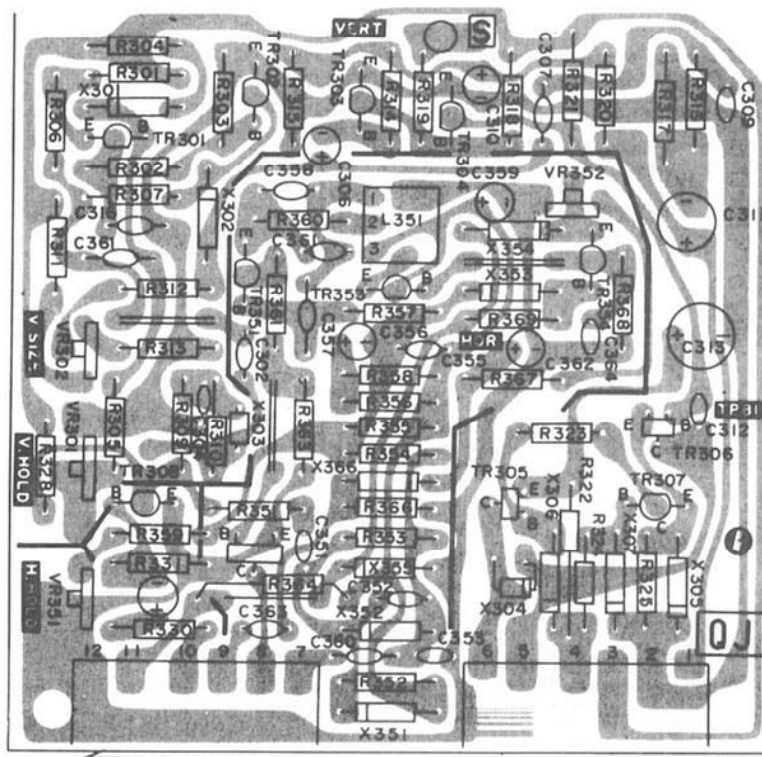

FIGURE 17. HORIZ/VERT P.C. BOARD MT/QJ

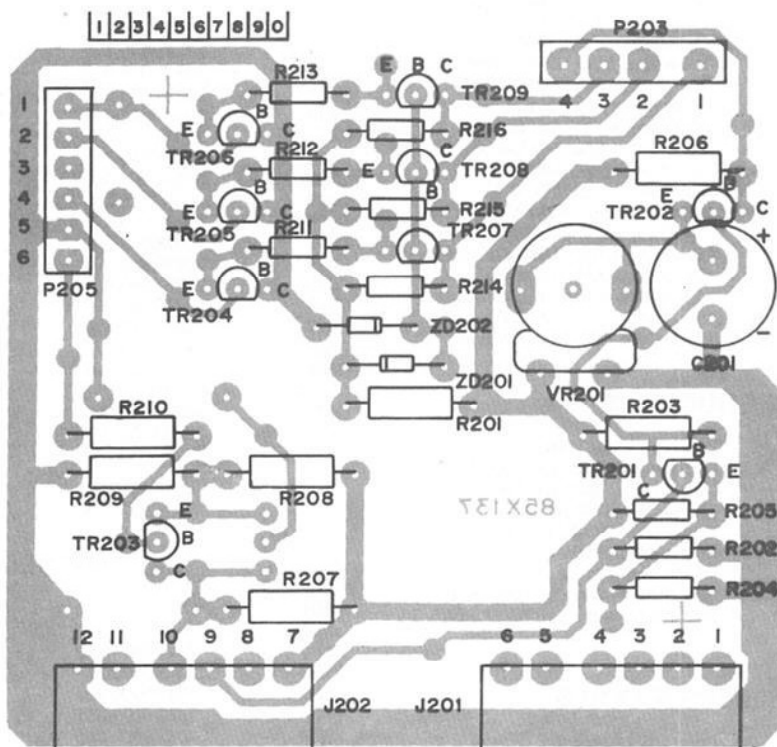

FIGURE 18. INTERFACE P.C. BOARD P297 P302

FOR MODELS 19K4601, 18K4602, 19K4604

REPLACEMENT PARTS LIST

△ ★ SAFETY CRITICAL PARTS LIST

This receiver contains circuits and components included specifically for safety purposes.

For continued protection no changes should be made to the original design, and components shown in shaded areas of schematic, or △★ on parts list should be replaced with exact factory replacement parts.

The use of substitute parts may create a shock, fire, x-radiation or other hazard. Service should be performed by qualified personnel only.

MAIN BOARD (MQ-29)

Ref. No.	Part No.	Description	Ref. No.	Part No.	Description
RESISTORS			CAPACITORS		
R605	203X9014-584	1k Ohm, ± 5%, 1W M.O.	△ C601	203X1800-451	0.1 uF, 125V, ± 20% MM
R606	204X1425-021	470 Ohm, ± 10%, 5W W.W.	△ C603	202X7810-214	2200 pF, 125V Ceramic
△ ★ R607	204X1450-508	2.7k Ohm, ± 10%, 5W W.W.	C608	203X0220-043	330 uF, 200V Electrolytic
R608	203X9014-603	1.2k Ohm, ± 5%, 1W M.O.	C605	203X1205-165	.0068 uF, 600V, ± 10% PP
R610	203X6500-246	22 Ohm, ± 5%, 1/8W Carbon	C607	203X0040-020	10 uF, 160V Electrolytic
R611	203X6700-562	1k Ohm, ± 5%, 1/2W Carbon	C608	203X0040-052	47 uF, 160V Electrolytic
R612	340X3471-944	470 Ohm, ± 10%, 1/2W Carbon	C609	202X7050-366	.0033 uF, 500V, ± 10% Ceramic
R613	203X9010-757	1.2k Ohm, ± 5%, 1W M.O.	C610	202X7050-483	.01 uF, 500V, ± 10% Ceramic
R614	203X5202-320	680k Ohm, ± 5%, 1/2W Comp.	C611	202X8140-022	100 pF, 3KV, ± 10% Ceramic
R615	203X5602-156	270k Ohm, ± 5%, 1/2W Comp.	C612	203X1201-047	.022 uF, 200V, ± 10% PP
R616	203X6500-741	2.7k Ohm, ± 5%, 1/8W Carbon	C613	203X0015-035	220 uF, 25V Electrolytic
R617	203X6501-088	68k Ohm, ± 5%, 1/8W Carbon	C614	203X0015-006	33 uF, 25V Electrolytic
R620	203X6500-508	270 Ohm, ± 5%, 1/8W Carbon	C615	203X1201-288	0.39 uF, 200V, ± 10% PP
R622	203X6500-689	1.5k Ohm, ± 5%, 1/8W Carbon	C616	202X8065-499	47 pF, 500V Ceramic
R624	203X6205-843	1k Ohm, ± 5%, 1/2W Carbon	C617	203X0025-019	1 uF, 50V Electrolytic
R630	203X5601-906	68k Ohm, ± 5%, 1/2W Carbon	C618	202X8000-577	82 pF, 50V, ± 5% Ceramic
R631	203X9015-087	2.2 Ohm, ± 10%, 5W M.O.	C619	203X0025-019	1 uF, 50V Electrolytic
R632	340X8111-731	110 Ohm, ± 5%, 5W Carbon	C620	203X1107-038	0.1 uF, 100V, ± 10% Mylar
*R632	340X8121-731	120 Ohm, ± 5%, 5W Carbon	C621	202X9040-155	0.1 uF, 1.5KV, ± 20% Paper
R634	203X6000-002	2.2 Ohm, ± 5%, 1/8W Carbon	C622	203X0020-099	1000 uF, 35V Electrolytic
R635	203X9014-842	12k Ohm, ± 5%, 1W M.O.	C623	203X0015-053	470 uF, 25V Electrolytic
R636	203X6500-645	1k Ohm, ± 5%, 1/8W Carbon	C624	203X0015-021	100 uF, 25V Electrolytic
R640	203X6500-762	3.3k Ohm, ± 5%, 1/8W Carbon	C625	203X0040-020	10 uF, 160V Electrolytic
R641	203X6501-002	33k Ohm, ± 5%, 1/8W Carbon	C626	202X7050-009	100 pF, 500V, ± 10% Ceramic
R642	203X6500-927	15k Ohm, ± 5%, 1/8W Carbon	C627	202X8065-461	39 pF, 500V, ± 10% Ceramic
R643	203X5602-648	3.9M Ohm, ± 5%, 1/2W Comp.	C628	202X7000-327	2200 pF, 50V, ± 10% Ceramic
R646	203X6500-468	180 Ohm, ± 5%, 1/8W Carbon	★ C629	203X1270-470	6900 pF, 1.5KV, ± 5% PP
R647	340X5150-841	15 Ohm, ± 10%, 2W Carbon	C630	202X7810-214	2200, pF, 125V Ceramic
*For Model K4603 Only			C632	203X0005-029	470 uF, 6.3V Electrolytic
SEMICONDUCTORS			C633	203X0315-033	2.2 uF, 50V Electrolytic <i>NON-POLAR</i>
TR601	200X3189-304	Transistor, 2SC1893	C634	202X8000-164	6 pF, 50V, ± 0.5 pF Ceramic
X601	201X3130-109	Rectifier, (SI) RM-2AV 600V	C637	202X8105-014	3 pF, 2 kV, ± 0.5 pF Ceramic
X605	200X8130-171	Diode (HS) SB-2CGL 1200V min.	C638	342X5632-040	.056 uF, 10% Mylar
X606	201X2010-144	Diode (SI) IS2473-772	MISCELLANEOUS		
X607	201X2100-119	Diode (HS) RC-2V 0.8 US	△ F601	204X7120-062	Fuse (UL/CSA) 3A-125
X608	201X2130-234	Diode (HS) RU-2V	J607	206X5003-960	Socket, 6 Pin
X609	201X2130-234	Diode (HS) RU-2V	P602	204X9600-260	Plug, 3 Pin (GT)
X610	66X0023-009	Rectifier, Power (SI) 500V PIV	P603	204X9600-254	Plug, 3 Pin (NM)
X611	66X0023-009	Rectifier, Power (SI) 500V PIV	P604	204X9600-298	Plug, 4 Pin (NM)
TRANSFORMERS & COILS			P606	204X9600-351	Plug, 6 Pin (NM)
△ L601	201X6000-112	Coil, Line Filter R-3	P607	204X9600-380	Plug, 6 Pin (GT)
L602	201X4600-042	Coil, Filter, 10 uH	P608	204X9600-254	Plug, 3 Pin (NM)
L603	201X4100-024	Coil, Peaking, 22 uH	P610	204X9600-249	Plug, 2 Pin (GT)
L607	201X4710-134	Coil, R-F Choke	P611	204X9600-670	Plug, 2 Pin (NM)
T601	201X9500-337	Transformer, Audio Output	TH601	201X011-034	Thermistor
T602	201X1300-080	Transformer, Hor. Drive	TH602	201X022-007	Varistor
T603	202X1210-191	Transformer, Side PC			
L702	9A2795-001	Horiz. Size			

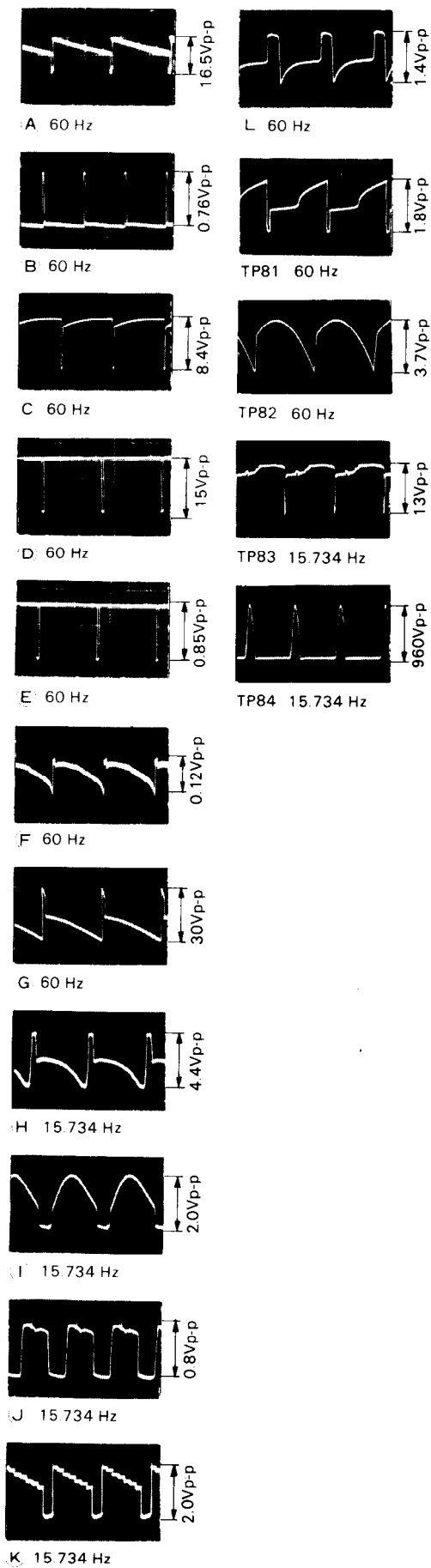

Power Supply Voltage and Symbols

Symbols	Line Voltage	Working Circuit
	15V	Vert. — Drive stage ABL — Bias CRT Cut-Off
	30V	Vert. Output Side pin Trans. — Bias
	127V	Horiz. Osc. Horiz. Drive Horiz. Output
	160V	Video Output
	890V	Screen-Bias



SERVICE TECHNICIAN WARNING X-RAY RADIATION PRECAUTION:

THIS PRODUCT CONTAINS CRITICAL ELECTRICAL AND MECHANICAL PARTS ESSENTIAL FOR X-RAY RADIATION PROTECTION.

FOR REPLACEMENT PURPOSES, USE ONLY TYPE PARTS SHOWN IN THE PARTS LIST.



CAUTION: FOR CONTINUED SAFETY, REPLACE SAFETY CRITICAL COMPONENTS ONLY WITH MANUFACTURER'S RECOMMENDED PARTS.

AVERTISSEMENT: POUR MAINTENIR LE DEGRE DE SECURITE DE L'APPAREIL NE REMPLACER LES COMPOSANTS DONT LE FONCTIONNEMENT EST CRITIQUE POUR LA SECURITE QUE PAR DES PIECES RECOMMANDEES PAR LE FABRICANT.

OSCILLOSCOPE WAVEFORM PATTERN

The waveforms shown are as observed on the wide band oscilloscope with the monitor turned to a reasonably strong signal and a normal picture. The voltages shown on each waveform are the approximate peak amplitudes. The frequency accompanying each waveform indicates the repetition rate of waveform not the sweep rate of the oscilloscope.

If the waveforms are observed on the oscilloscope with a poor high frequency response, the corner of the pulses will tend to be more rounded than those shown and the amplitude of any high frequency pulse will tend to be less.

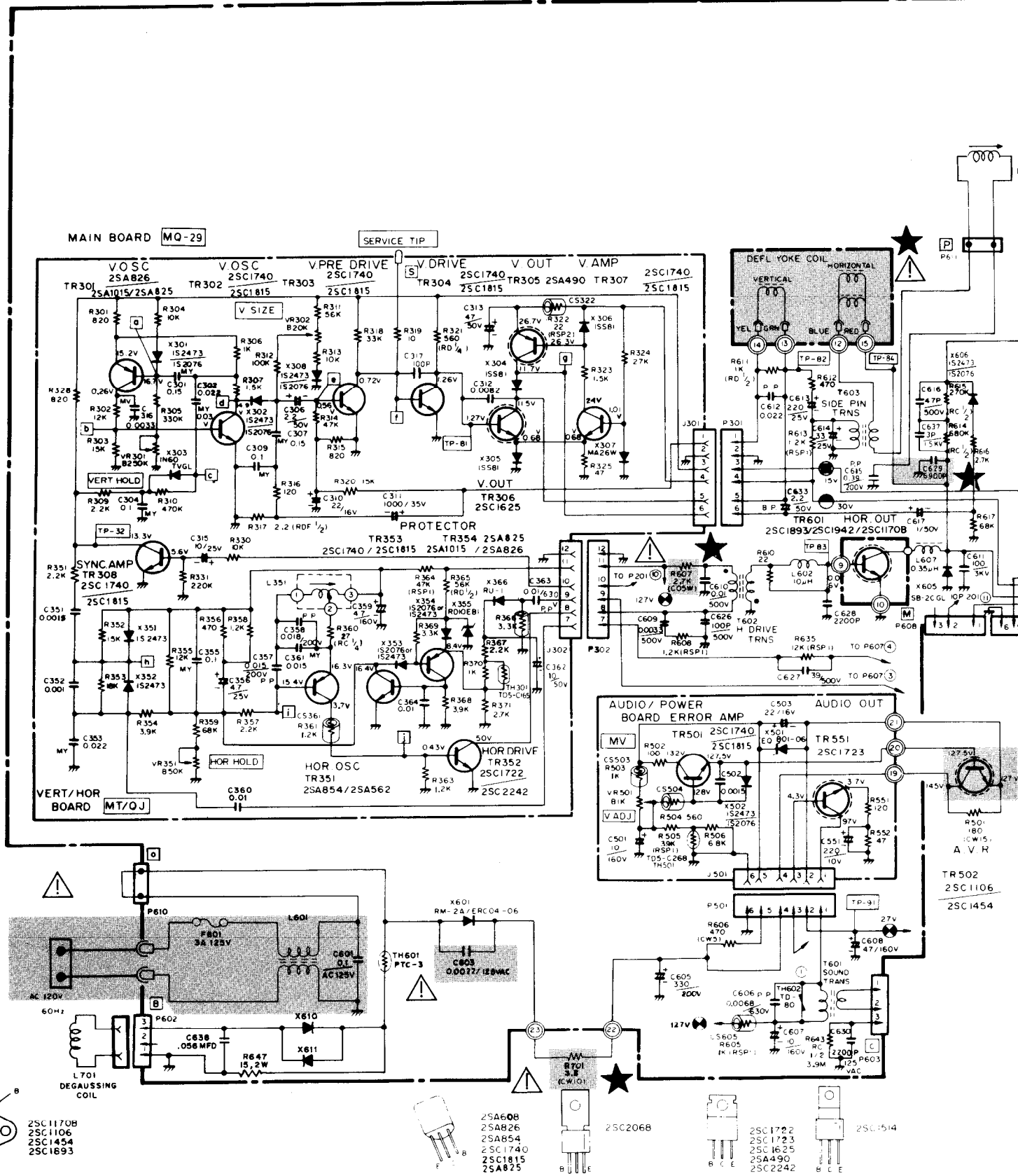

19" COLOR MONITOR SCHEMATIC DIAGRAM

MODEL 19K4601

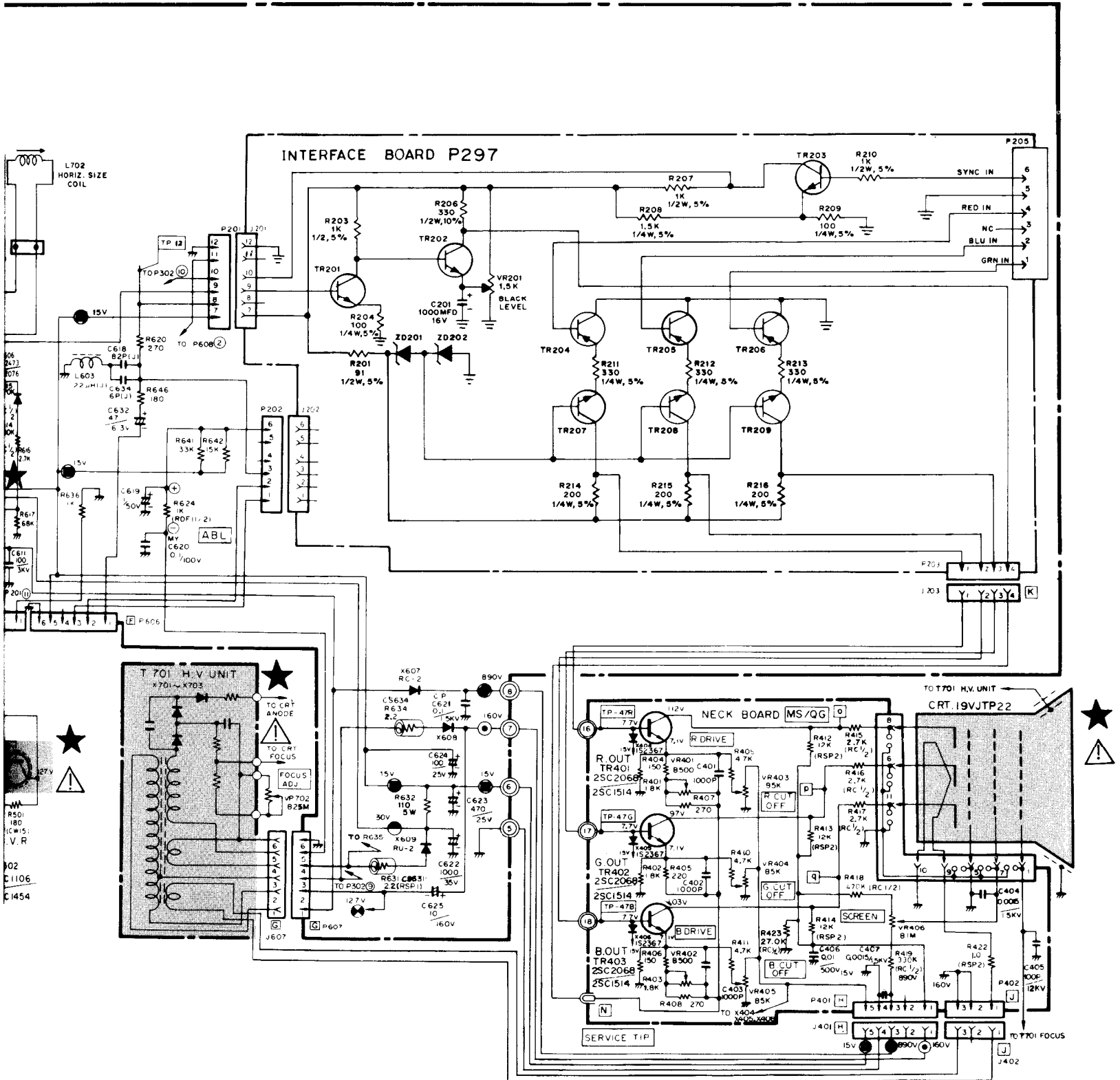

K4601-5795

VERT/HOR BOARD (MT/QJ)

Ref. No.	Part No.	Description	Ref. No.	Part No.	Description
RESISTORS			CAPACITORS (CONT.)		
R301	203X6500-628	820 Ohm, ± 5%, 1/8W Carbon	C313	203X0025-087	47 uF, 50V Electrolytic
R302	203X6500-902	12k Ohm, ± 5%, 1/8W Carbon	C315	203X0015-082	10 uF, 25V Electrolytic
R303	203X6500-927	15k Ohm, ± 5%, 1/8W Carbon	C316	203X1100-220	3300 uF, 50V, ± 10% Mylar
R304	203X6500-886	10k Ohm, ± 5%, 1/8W Carbon	C317	202X8000-616	100 pF, 50V, ± 10% Ceramic
R305	203X6501-241	330k Ohm, ± 5%, 1/8W Carbon	C351	202X7000-281	1500 pF, 50V, ± 10% Ceramic
R306	203X6500-645	1k Ohm, ± 5%, 1/8W Carbon	C352	202X7000-247	1000 pF, 50V, ± 10% Ceramic
R307	203X6500-689	1.5k Ohm, ± 5%, 1/8W Carbon	C353	203X1100-573	0.022 uF, 50V, ± 10% Mylar
R309	203X6500-724	2.2k Ohm, ± 5%, 1/8W Carbon	C355	203X1100-858	0.1 uF, 50V, ± 10% Mylar
R310	203X6501-285	470k Ohm, ± 5%, 1/8W Carbon	C356	203X0015-105	4.7 uF, 25V Electrolytic
R311	203X6501-065	56k Ohm, ± 5%, 1/8W Carbon	C357	203X1201-013	0.015uF, 200V ± 10% PP
R312	203X6501-126	100k Ohm, ± 5%, 1/8W Carbon	C358	203X1201-034	0.018 uF, 200V, ± 10% PP
R313	203X6001-326	10k Ohm, ± 5%, 1/8W Carbon	C359	203X0040-013	4.7 uF, 160V Electrolytic
R314	203X6501-044	47k Ohm, ± 5%, 1/8W Carbon	C360	202X7000-482	0.01 uF, 50V, ± 10% Ceramic
R315	203X6500-628	820 Ohm, ± 5%, 1/8W Carbon	C361	203X1100-509	0.015 uF, 50V, ± 10% Mylar
R316	203X6500-420	120 Ohm, ± 5%, 1/8W Carbon	C362	203X0025-058	10 uF, 50V Electrolytic
R317	203X6206-441	2.2 Ohm, ± 5%, 1/2W Carbon	C363	203X1205-487	0.01 uF, 630V, ± 10% PP
R319	203X6500-169	100 Ohm, ± 5%, 1/8W Carbon	C364	202X7000-482	0.01 uF, 50V, ± 10% Ceramic
R320	203X6500-927	15k Ohm, ± 5%, 1/8W Carbon			
R321	203X6700-509	560 Ohm, ± 5%, 1/2W Carbon			
R322	203X9100-121	22 Ohm, ± 5%, 2W M.O.			
R323	203X6500-689	1.5K Ohm, ± 5%, 1/8W Carbon			
R324	203X6500-988	27k Ohm, ± 5%, 1/8W Carbon	TR301	200X4082-614	Transistor, 2SA826Q
R325	203X6500-326	47 Ohm, ± 5%, 1/8W Carbon	TR302	200X3174-006	Transistor, 2SC1740Q
R328	203X6500-628	820 Ohm, ± 5%, 1/8W Carbon	TR303	200X3174-006	Transistor, 2SA1740Q
R330	203X6500-886	10k Ohm, ± 5%, 1/8W Carbon	TR304	200X3174-006	Transistor, 2SC1740Q
R331	203X6501-209	220k Ohm, ± 5%, 1/8W Carbon	TR305	200X4049-081	Transistor, 2SA490YLBGLI
R351	203X6500-724	2.2k Ohm, ± 5%, 1/8W Carbon	TR306	200X3162-538	Transistor, 2SC1625YLBGLI
R352	203X6500-927	15k Ohm, ± 5%, 1/8W Carbon	TR307	200X3174-014	Transistor, 2SC1740R
R353	203X6500-944	18k Ohm, ± 5%, 1/8W Carbon	TR308	200X3174-006	Transistor, 2SC1740Q
R354	203X6500-783	3.9k Ohm, ± 5%, 1/8W Carbon	TR351	200X4085-415	Transistor, 2SA854Q
R355	203X6500-902	12k Ohm, ± 5%, 1/8W Carbon	TR352	200X3172-208	Transistor, 2SC1722BKS
R356	203X6500-561	470 Ohm, ± 5%, 1/8W Carbon	TR353	200X3174-006	Transistor, 2SC1740Q
R357	203X6500-724	2.2k Ohm, ± 5%, 1/8W Carbon	TR354	200X4082-614	Transistor, 2SA826Q
R358	203X6500-666	1.2k Ohm, ± 5%, 1/8W Carbon	X301	201X2010-144	Diode, (SI) IS2473-T72
R359	203X6501-088	68k Ohm, ± 5%, 1/8W Carbon	X302	201X2010-144	Diode, (SI) IS2473-T72
R360	203X5500-471	27 Ohm, ± 5%, 1/4W Comp.	X303	200X8000-026	Diode, (GE), IN60TVGL
R361	203X6000-998	1.2k Ohm, ± 5%, 1/8W Carbon	X304	200X8010-165	Diode (SI) ISS81
R363	203X6500-666	1.2k Ohm, ± 5%, 1/8W Carbon	X305	201X2010-165	Diode (SI) ISS81
R364	203X9014-988	47k Ohm, ± 5%, 1W M.O.	X306	201X2010-165	Diode (SI) ISS81
R365	203X6700-989	56k Ohm, ± 5%, 1/2W Carbon	X307	200X8010-102	Diode (SI) MA26W
R366	203X6001-148	3.3k Ohm, ± 5%, 1/8W Carbon	X308	200X8010-094	Diode (SI) IS2473
R367	340X2222-734	2.2k Ohm, ± 5%, 1/2W Carbon	X351	201X2010-144	Diode (SI) IS2473-T72
R368	203X6500-785	3.9k Ohm, ± 5%, 1/8W Carbon	X352	201X2010-144	Diode (SI) IS2473-T72
R369	203X6500-762	3.3k Ohm, ± 5%, 1/4W Carbon	X353	201X2010-144	Diode (SI) IS2473-T72
R370	302X6100-961	1k Ohm, ± 5%, 1/4W Carbon	X354	201X2010-144	Diode (SI) IS2473-T72
R371	203X6104-751	2.7k Ohm, ± 5%, 1/4W Carbon	X355	200X8220-851	Diode (Zener) RD10EBI
VR301	204X2122-093	Varistor, 250K Ohm, Vert. Hold	X366	200X8100-130	Diode (HS) RU-1 0.3 US
VR302	204X2114-065	Varistor, 20K Ohm, Vert. Size			
VR351	204X2114-059	Varistor, 50K Ohm, Hor. Hold			
CAPACITORS			MISCELLANEOUS		
C301	203X1100-928	0.15 uF, 50V, ± 10% Mylar	J301	204X9300-958	Socket, 6 Pin
C302	203X1100-573	0.022 uF, 50V, ± 10% Mylar	J302	204X9300-958	Socket, 6 Pin
C304	203X1100-858	0.1 uF, 50V, ± 10% Mylar	P301	204X9601-195	Plug, 6 Pin
C306	203X0025-026	2.2 uF, 50V, Electrolytic	P302	204X9601-195	Plug, 6 Pin
C307	203X1100-928	0.15 uF, 50V, ± 10% Mylar	TH301	201X0000-534	Thermistor
C309	203X1100-858	0.1 uF, 50V, ± 10% Mylar			
C310	203X0010-011	22 uF, 16V Electrolytic			
C311	203X0020-099	1000 uF, 35V Electrolytic			
C312	202X7000-469	0.0082 uF, 50V, ± 10% Ceramic			
POWER BOARD (MV)			TRANSFORMERS & COILS		
RESISTORS			L351	201X5200-091	Coil, Horiz. Osc.
R501	204X1725-052	180 Ohm, ± 10%, 15W WW			
R502	203X6000-608	100 Ohm, ± 5%, 1/8W Carbon			
R503	203X6000-960	1k Ohm, ± 5%, 1/8W Carbon			
R504	203X6000-879	560 Ohm, ± 5%, 1/8W Carbon			
R505	203X9014-965	39k Ohm, ± 5%, 1W M.O.			
R506	203X6500-842	6.8k Ohm, ± 5%, 1/8W Carbon			
R551	203X6500-420	120 Ohm, ± 5%, 1/8W Carbon			
VR501	204X2050-001	Varistor Vert. Adj.			
CAPACITORS			SEMICONDUCTORS		
C501	203X0040-020	10 uF, 160V Electrolytic	C503	203X0010-011	22 uF, 16V Electrolytic
C502	202X7000-281	1500 pF, 50V, ± 10% Ceramic	C551	203X0005-046	220 uF, 10V Electrolytic
			TR501	200X3174-006	Transistor, 2SC1740Q
			★ TR502	200X3145-404	Transistor, 2SC1454
			TR551	200X3172-305	Transistor, 2SC1723
			X501	201X2230-042	Diode, (SI) Zener EQB01-06V
			X502	201X2010-144	Diode, (SI) IS2473-T72
MISCELLANEOUS			MISCELLANEOUS		
			J501	204X9300-958	Socket, 6 Pin
			P501	204X9601-195	Plug, 6 Pin
			TH501	201X0000-618	Thermistor

NECK BOARD (MS/QG)

Ref. No.	Part No.	Description	Ref. No.	Part No.	Description
RESISTORS					
R401	203X6500-709	1.8k Ohm ± 5% 1/8W Carbon	C403	202X7000-247	1000 pF, 50V, 10% Ceramic
R402	203X6500-709	1.8k Ohm ± 5% 1/8W Carbon	C404	202X7110-019	1500 pF, 2kV ± 10% Ceramic
R403	203X6500-709	1.8k Ohm ± 5% 1/8W Carbon	C405	202X7150-018	100 pF, 12kV, ± 10% Ceramic
R404	203X6500-447	150 Ohm ± 5% 1/8W Carbon	C406	202X7050-483	.01 uF, 500V, ± 10% Ceramic
R405	203X6500-481	220 Ohm ± 5% 1/8W Carbon	C407	202X7110-019	1500 pF, 2kV ± 10% Ceramic
R406	203X6500-447	150 Ohm ± 5% 1/8W Carbon	C408	202X8000-550	68 pF, 50V, ± 10% Ceramic
R407	203X6500-508	270 Ohm ± 5% 1/8W Carbon	C409	202X8000-550	68 pF, 50V, ± 10% Ceramic
R408	203X6500-508	270 Ohm ± 5% 1/8W Carbon	C410	202X8000-550	68 pF, 50V, ± 10% Ceramic
R409	203X6500-800	4.7k Ohm ± 5% 1/8W Carbon	SEMICONDUCTORS		
R410	203X6500-800	4.7k Ohm ± 5% 1/8W Carbon	TR401	200X3206-800	Transistor, 2SC2068, 2SC1514 (R output)
R411	203X6500-800	4.7k Ohm ± 5% 1/8W Carbon	TR402	200X3206-800	Transistor, 2SC2068, 2SC1514 (G output)
R412	203X9104-809	12k Ohm ± 5% 2.0W Metal Oxide	TR403	200X3206-800	Transistor, 2SC2068, 2SC1514 (B output)
R413	203X9104-809	12k Ohm ± 5% 2.0W Metal Oxide	X404	201X2100-126	Diode, IS2367 (protector)
R414	203X9104-809	12k Ohm ± 5% 2.0W Metal Oxide	X405	201X2100-126	Diode, IS2367 (protector)
R415	203X5601-313	2.7k Ohm ± 10% 1/2W Comp.	X406	201X2100-126	Diode, IS2367 (protector)
R416	203X5601-313	2.7k Ohm ± 10% 1/2W Comp.			
R417	203X5601-313	2.7k Ohm ± 10% 1/2W Comp.			
R418	203X5602-254	470k Ohm ± 10% 1/2W Comp.			
R419	203X5602-185	330k Ohm ± 10% 1/2W Comp.			
R422	203X9105-117	1.0 Ohm ± 10% 2W Metal Oxide			
R423	203X5102-155	270k Ohm ± 5% 1/4W Carbon			
VR401	204X2115-014	500 Ohm Varistor R Drive			
VR402	204X2115-014	500 Ohm Varistor B Drive			
VR403	204X2115-006	5k Ohm Varistor R Cutoff			
VR404	204X2115-006	5k Ohm Varistor G Cutoff			
VR405	204X2115-006	5k Ohm Varistor B Cutoff			
VR406	204X2000-025	1M Ohm Varistor Screen			

CAPACITORS

C401	202X7000-247	1000 pF, 50V, 10% Ceramic
C402	202X7000-247	1000 pF, 50V, 10% Ceramic

MISCELLANEOUS

J401	206X5003-729	Socket, 5 Pin
J402	206X5003-983	Socket, 3 Pin
P401	204X9600-329	Plug, 5 Pin
P402	204X9600-254	Plug, 3 Pin

▲★ 297X2000-072 HIGH VOLTAGE ASSEMBLY (T701)

▲★ R701	204X1625-058	3.3 Ohm, ± 10% 10W WW Resistor
VR702	204X3901-125	Focus Control
X701		Diode (SI HV) } Part of T701
X702		Diode (SI HV) }
X703		Diode (SI HV) }

FINAL ASSEMBLY PARTS

▲★ 88X-0129-506	19VJTP22 Pix Tube
38A5554-000	Assy. Purity Shld/Degaussing
205X9800-256	Lateral/Purity Assembly
▲★ 202X1110-810	Yoke, Deflection
208X2000-946	CRT Socket
297X2000-072	HV Unit (T701)
6A0397	Plug, Line Cord
9A2753-003	Degaussing Coil (L701)

INTERFACE BOARD (P297)

(MODEL 19K4601)

RESISTORS

R201	340X3910-934	91 Ohm, 5%, 1/2W Carbon
R203	340X3102-934	1k Ohm, 5%, 1/2W Carbon
R204	340X2101-934	100 Ohm, 5%, 1/4W Carbon
R206	340X3331-944	330 Ohm, 10%, 1/2W Carbon
R207	340X3102-934	1k Ohm, 5%, 1/2W Carbon
R208	340X2152-934	1.5k Ohm, 5%, 1/4W Carbon
R209	340X2101-934	100 Ohm, 5%, 1/4W Carbon
R210	340X3102-934	1k Ohm, 5%, 1/2W Carbon
R211	340X2331-934	330 Ohm, 5%, 1/4W Carbon
R212	340X2331-934	330 Ohm, 5%, 1/4W Carbon
R213	340X2331-934	330 Ohm, 5%, 1/4W Carbon
R214	340X2201-934	200 Ohm, 5%, 1/4W Carbon
R215	340X2201-934	200 Ohm, 5%, 1/4W Carbon
R216	340X2201-934	200 Ohm, 5%, 1/4W Carbon
VR201	40X0590-017	1.5k Ohm, Black Level Control

CAPACITORS

C201	45X0524-038	1000 uF, 16V Electrolytic
------	-------------	---------------------------

SEMICONDUCTORS

TR201	86X0121-001	Transistor (NPN)
TR202	86X0121-001	Transistor (NPN) <i>2N3904</i>
TR203	86X0121-001	Transistor (NPN)
TR204	86X0066-001	Transistor (PNP)
TR205	86X0066-001	Transistor (PNP)
TR206	86X0066-001	Transistor (PNP)
TR207	86X0121-001	Transistor (NPN)
TR208	86X0121-001	Transistor (NPN)
TR209	86X0121-001	Transistor (NPN)
ZD201	66X0040-018	Diode, Zener, 6.8v, 5%, 0.5W
ZD202	66X0040-019	Diode, Zener, 3.9v, 5%, 0.5W

MISCELLANEOUS

J201	204X9300-958	Socket, 6 Pin
J202	204X9300-958	Socket, 6 Pin
J203	206X5019-207	Socket, 4 Pin
P201	204X9601-195	Plug, 6 Pin
P202	204X9601-195	Plug, 6 Pin
P203	204X9600-845	Plug, 4 Pin
P205	6A0393-006	Plug, 6 Pin

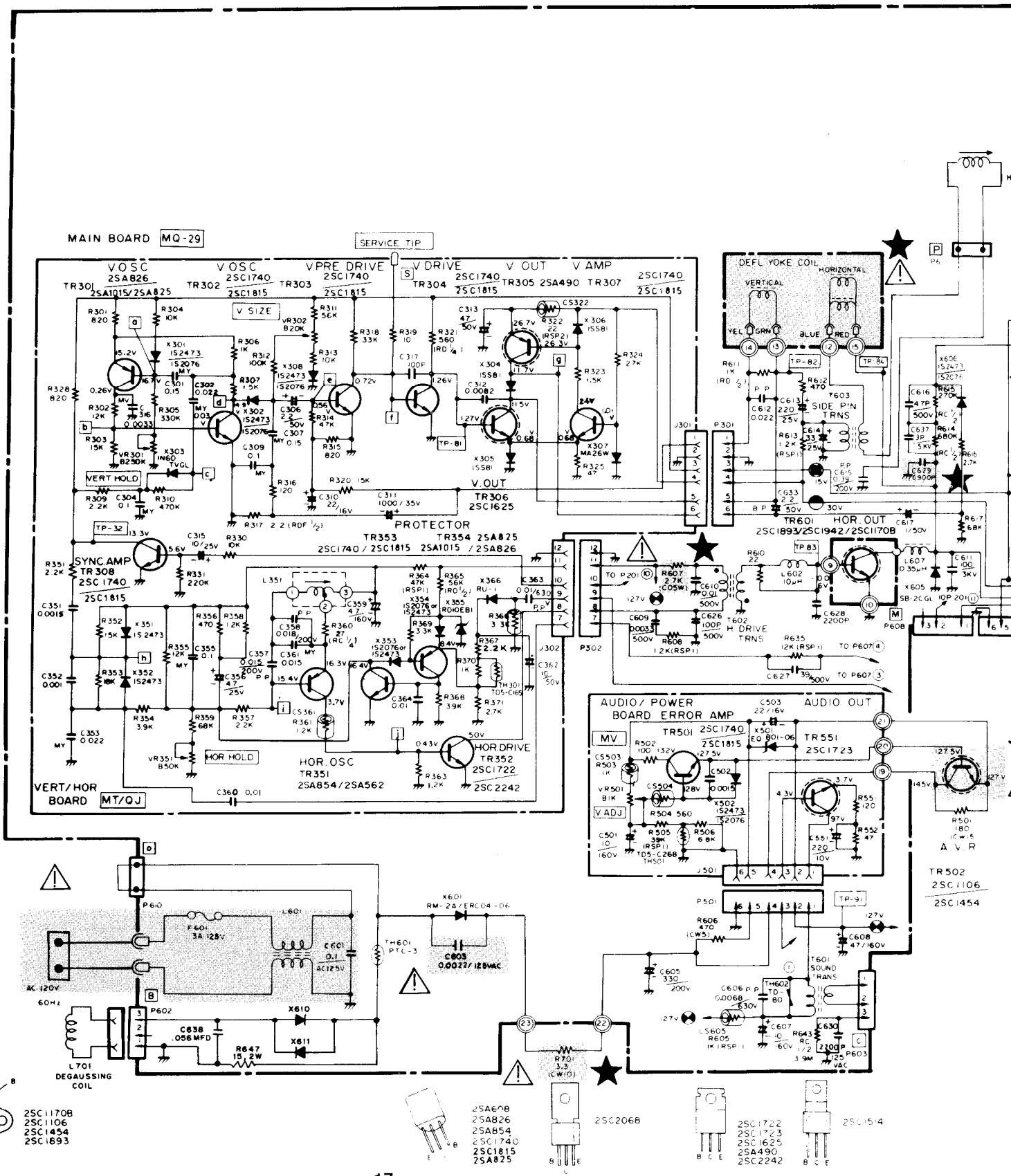

MAIN BOARD MQ-29

SERVICE TIP

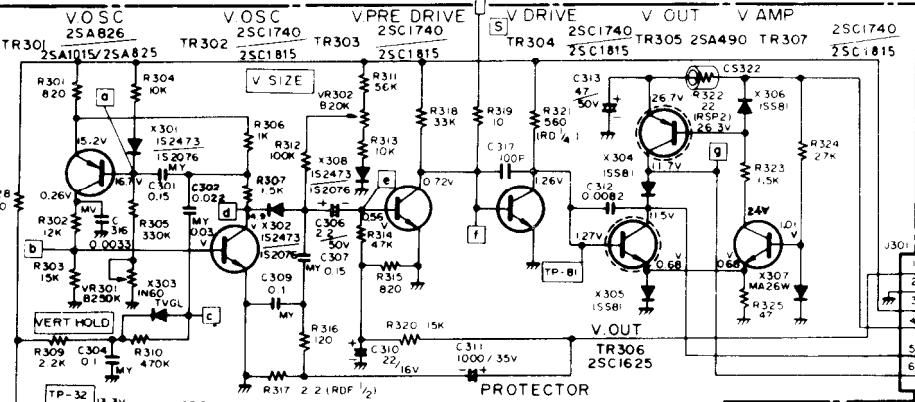

SYNC AMP TR308 2SC1740

PROTECTOR TR353 TR354 2SA825 2SC1740 / 2SC1815 2SA1015 / 2SA826

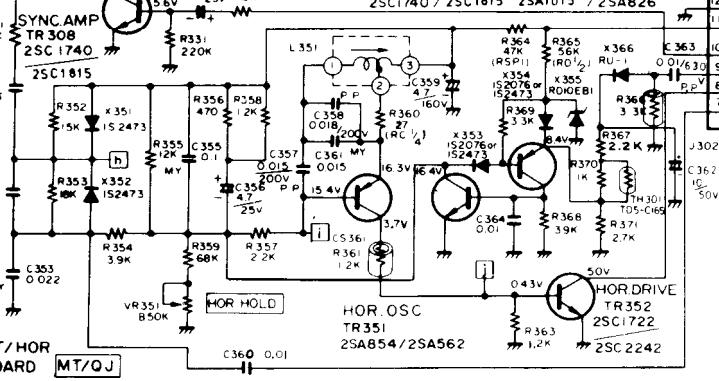

VERT/HOR BOARD MT/QJ

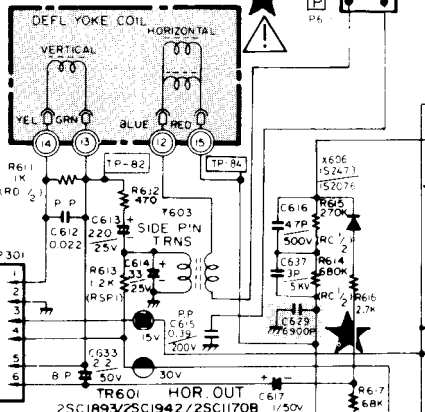

DEFLECTION Yoke COILS VERTICAL HORIZONTAL

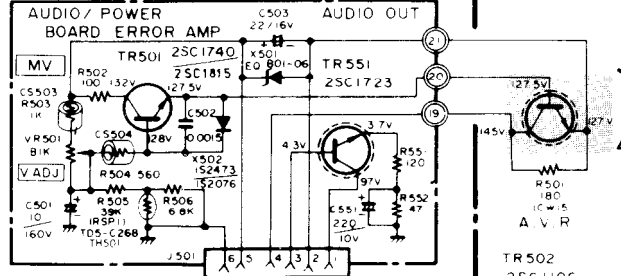

AUDIO/POWER BOARD ERROR AMP

AUDIO OUT

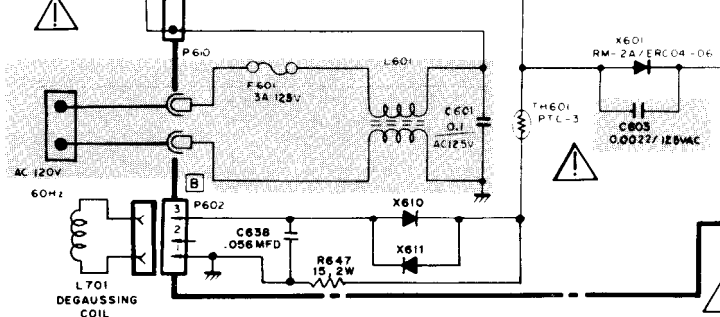

AC 120V 60Hz

L701 DEGAUSSING COIL

2SC1170B 2SC1106 2SC1454 2SC1815

2SA678 2SA826 2SA854 2SC1740 2SC1815 2SA825

2SC2068

2SC1722 2SC1723 2SC1625 2SA490 2SC2242

2SC1514

19" COLOR MONITOR SCHEMATIC DIAGRAM

MODEL 19K4602

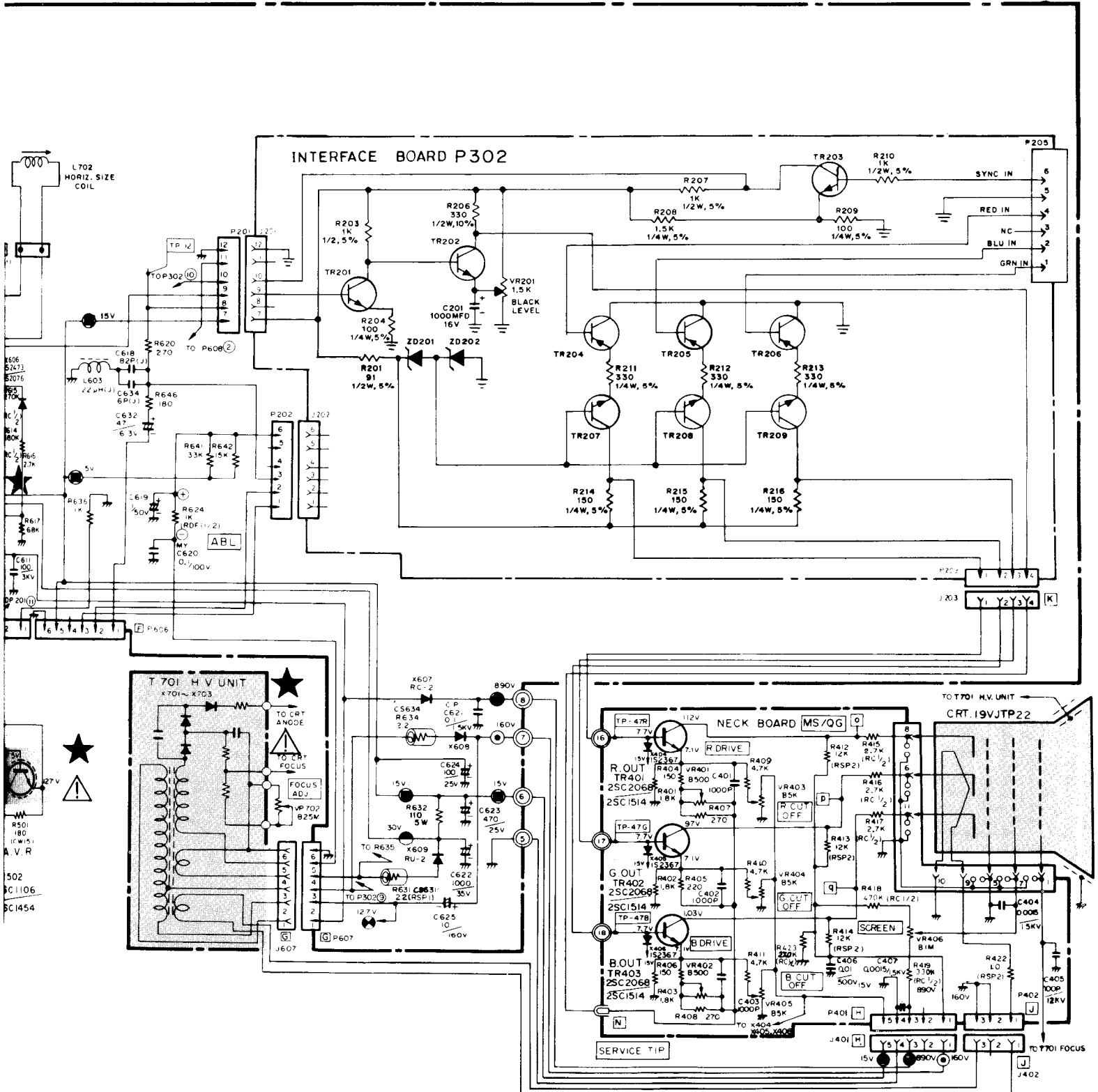

K4602-5796

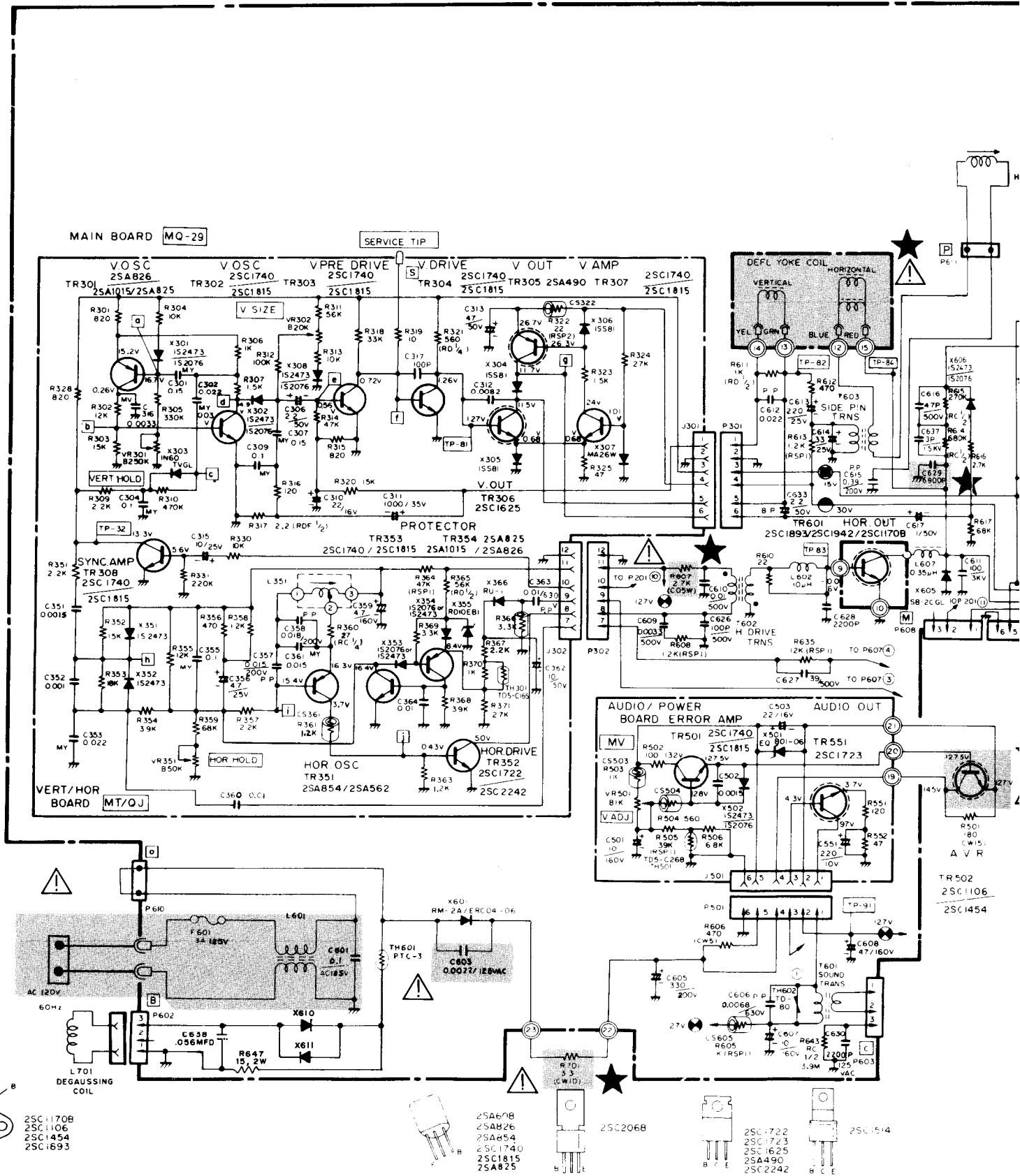

19" COLOR MONITOR SCHEMATIC DIAGRAM

MODELS 19K4603 & 19K4653

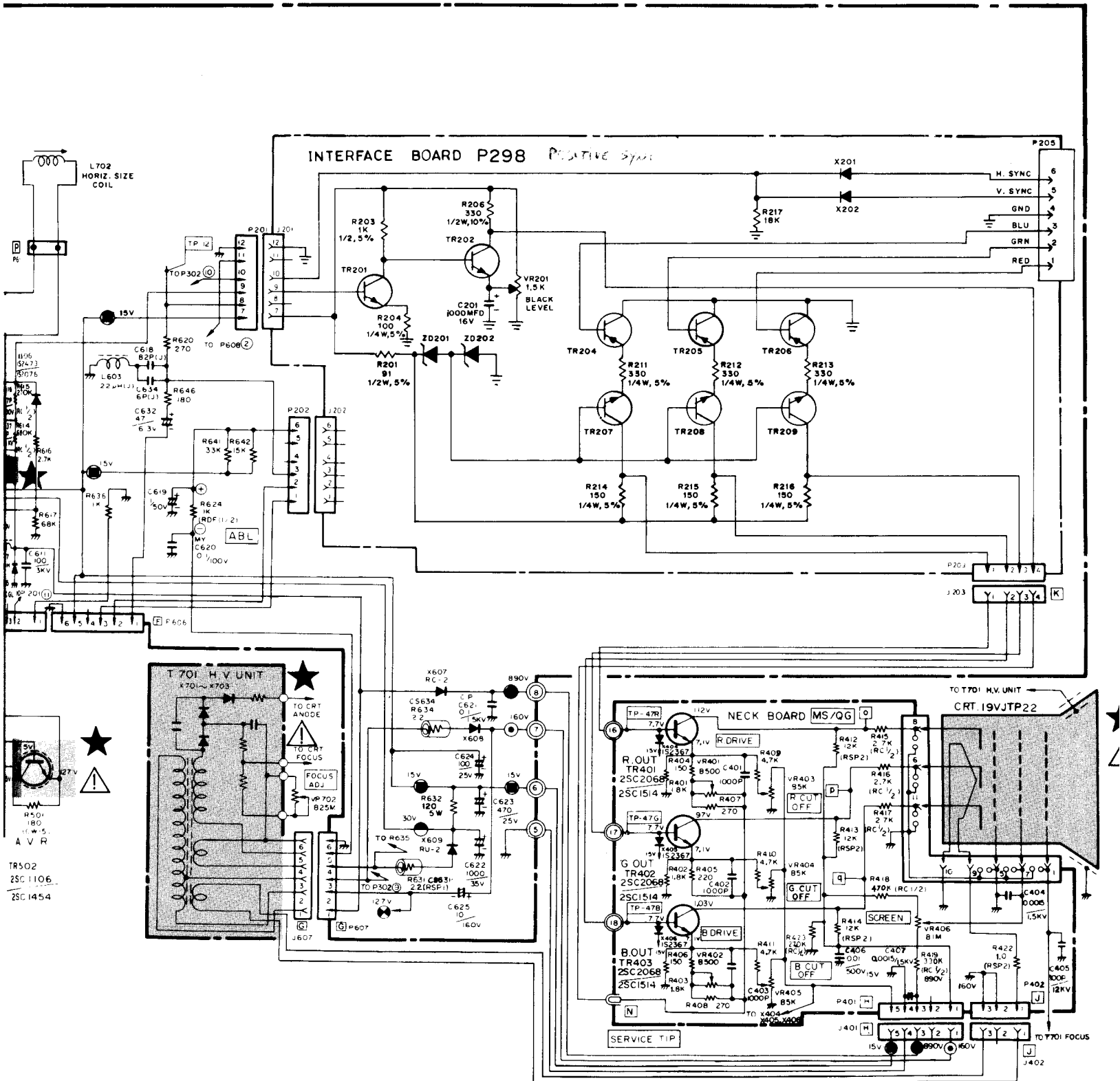

K4603 / K4653-5797

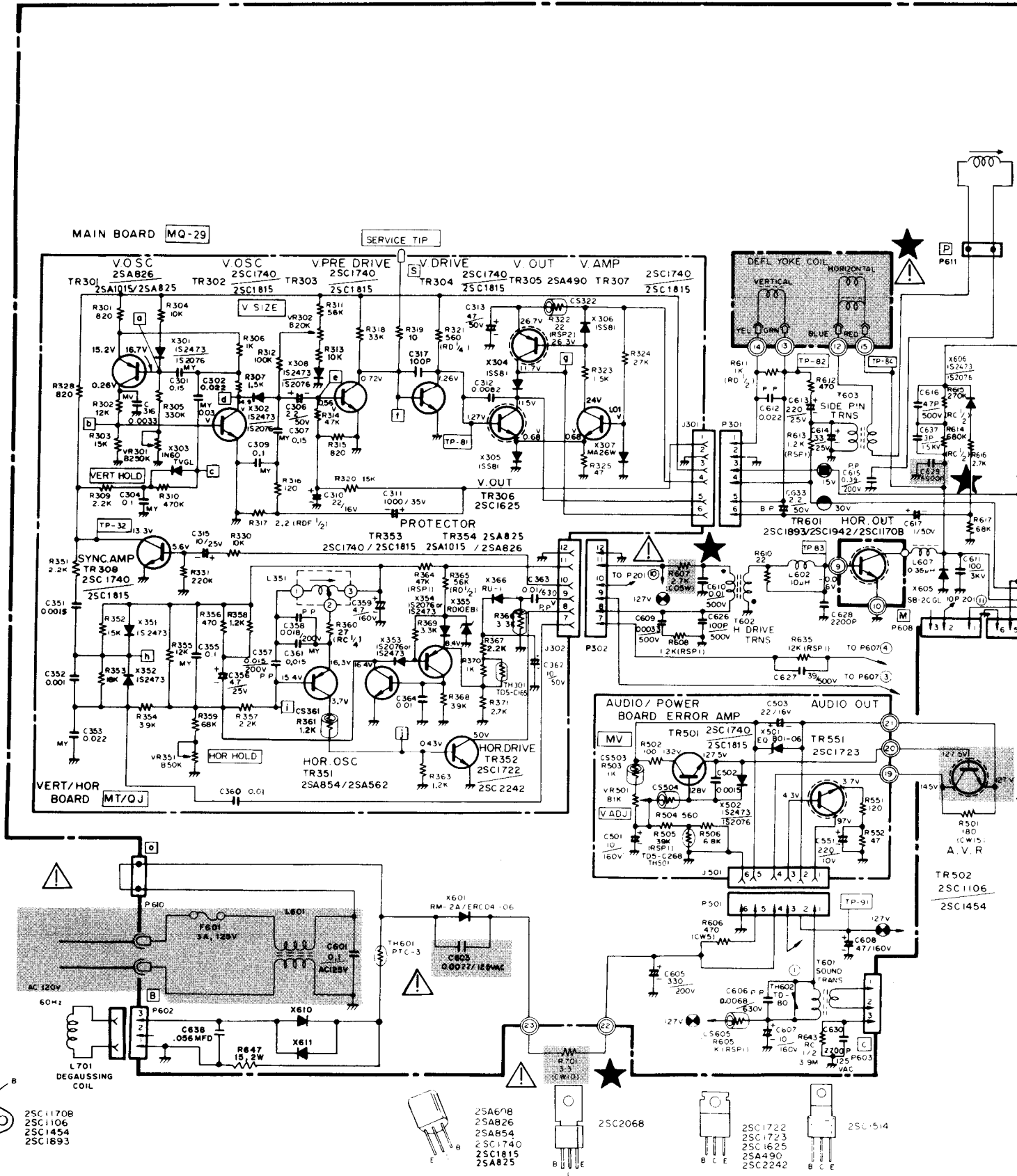

19" COLOR MONITOR SCHEMATIC DIAGRAM

MODEL 19K4604

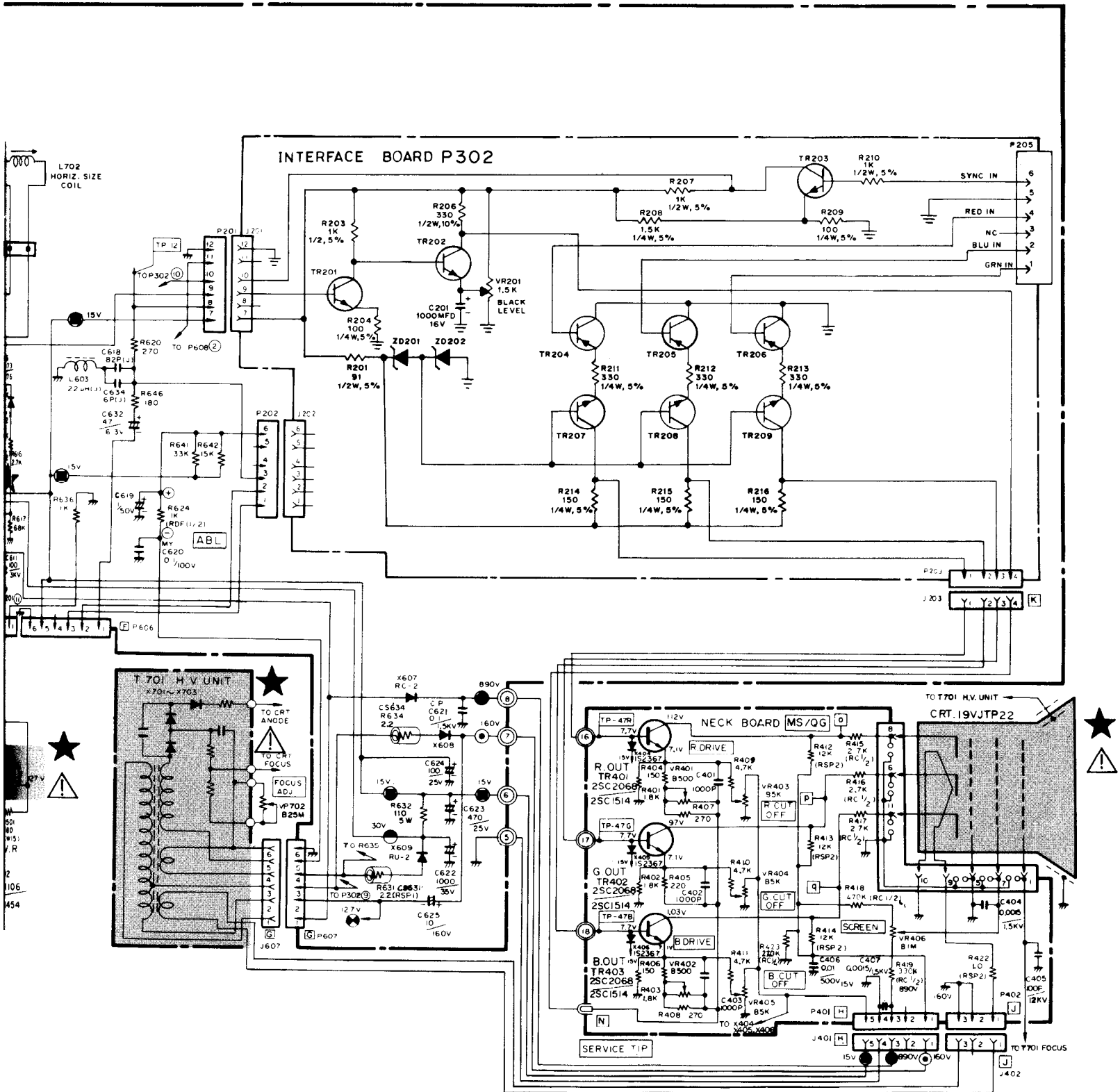

K4604-5798

**INTERFACE BOARD (P302)
(MODELS 19K4602 & 19K4604)**

Ref. No.	Part No.	Description	Ref. No.	Part No.	Description
RESISTORS			SEMICONDUCTORS		
R201	340X3910-934	91 Ohm, \pm 5%, 1/2W Carbon	TR201	86X0121-001	Transistor (NPN)
R203	340X2102-934	1k Ohm \pm 5% 1/2W Carbon	TR202	86X0121-001	Transistor (NPN)
R204	340X2101-934	100 Ohm \pm 5% 1/8W Carbon	TR203	86X0121-001	Transistor (NPN)
R206	340X3331-944	330 Ohm \pm 5% 1/2W Carbon	TR204	86X0066-001	Transistor (PNP)
R207	340X3102-934	1k Ohm \pm 5% 1/2W Carbon	TR205	86X0066-001	Transistor (PNP)
R208	340X2152-934	1.5k Ohm \pm 5% 1/4W Carbon	TR206	86X0066-001	Transistor (PNP)
R209	340X2101-934	100 Ohm \pm 5% 1/4W Carbon	TR207	86X0121-001	Transistor (NPN)
R210	340X3102-934	1k Ohm \pm 5% 1/2W Carbon	TR208	86X0121-001	Transistor (NPN)
R211	340X2331-934	330 Ohm \pm 5% 1/4W Carbon	TR209	86X0121-001	Transistor (NPN)
R212	340X2331-934	330 Ohm \pm 5% 1/4W Carbon	ZD201	66X0040-018	Diode, Zener 6.8V, 5%, 0.5W
R213	340X2331-934	330 Ohm \pm 5% 1/4W Carbon	ZD202	66X0040-019	Diode, Zener 3.9V, 5%, 0.5W
R214	340X2151-934	150 Ohm \pm 5% 1/4W Carbon			
R215	340X7151-934	150 Ohm \pm 5% 1/4W Carbon			
R216	340X2151-934	150 Ohm \pm 5% 1/4W Carbon			
VR201	40X0590-017	1.5k Ohm, Black Level Control			

CAPACITORS

C201	45X0524-038	1000 uF, 16V Electrolytic
------	-------------	---------------------------

MISCELLANEOUS

J201	204X9300-958	Socket, 6 Pin
J202	204X9300-958	Socket, 6 Pin
J203	206X5019-207	Socket, 4 Pin
P201	204X9601-195	Plug, 6 Pin
P202	204X9601-195	Plug, 6 Pin
P203	204X9600-845	Plug, 4 Pin
P205	6A0393-006	Plug, 6 Pin

**INTERFACE BOARD (P298)
(MODELS 49K4603 & 19K4653)**

RESISTORS

R201	340X3910-934	91 Ohm \pm 5% 1/2W Carbon	TR204	86X0066-001	Transistor (PNP)
R203	340X3102-934	1k Ohm \pm 5% 1/2W Carbon	TR205	86X0066-001	Transistor (PNP)
R204	340X2101-934	100 Ohm \pm 5% 1/4W Carbon	TR206	86X0066-001	Transistor (PNP)
R206	340X3331-944	330 Ohm \pm 10% 1/2W Carbon	TR207	86X0121-001	Transistor (NPN)
R208	340X2152-934	1.5k Ohm \pm 5% 1/4W Carbon	TR208	86X0121-001	Transistor (NPN)
R211	340X2331-934	330 Ohm \pm 5% 1/4W Carbon	TR209	86X0121-001	Transistor (NPN)
R212	340X2331-934	330 Ohm \pm 5% 1/4W Carbon	X201	66X0046-001	Diode, Silicon
R213	340X2331-934	330 Ohm \pm 5% 1/4W Carbon	X202	66X0046-001	Diode, Silicon
R214	340X2151-934	150 Ohm \pm 5% 1/4W Carbon	ZD201	66X0040-018	Diode, Zener 6.8V, 5%, 0.5W
R215	340X2151-934	150 Ohm \pm 5% 1/4W Carbon	ZD202	66X0040-019	Diode, Zener 3.9V, 5%, 0.5W
R216	340X2151-934	150 Ohm \pm 5% 1/4W Carbon			
R217	340X3183-944	18k Ohm \pm 5% 1/2W Carbon			
VR201	40X0590-017	1.5k Ohm, Black Level Control			

CAPACITORS

C201	45X0524-038	1000 uF, 16V Electrolytic
------	-------------	---------------------------

SEMICONDUCTORS

TR201	86X0121-001	Transistor (NPN)
TR202	86X0121-001	Transistor (NPN)

MISCELLANEOUS

J201	204X9300-958	Socket, 6 Pin
J202	204X9300-958	Socket, 6 Pin
J203	206X5019-207	Socket, 4 Pin
P201	204X9601-195	Plug, 6 Pin
P202	204X9601-195	Plug, 6 Pin
P203	20X9600-845	Plug, 4 Pin
P205	6A0393-006	Plug, 6 Pin

PC BOARD LAYOUT

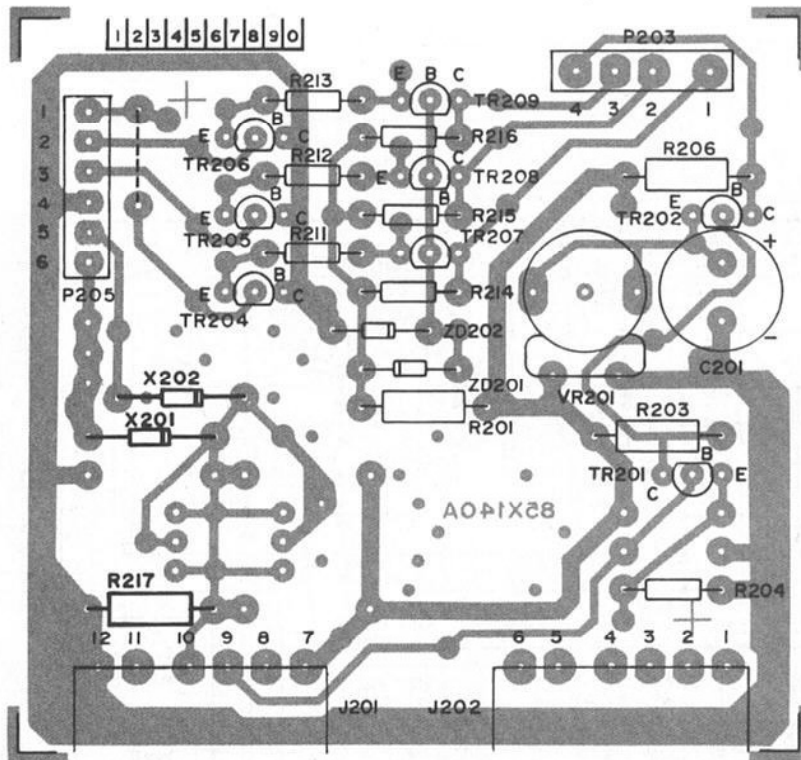

FIGURE 19-INTERFACE PC BOARD P298
 MODELS 19K4603, 19K4653

Positive sync