

CONTRACTS MARKETING 

ELECTROHOME ELECTRONICS

54-7293-01

THIS INFORMATION IS UP TO DATE AS OF MAY 1980

---

# **SERVICE AND OPERATION MANUAL**

## **G07-13" R.G.B. COLOUR MONITOR**

---

ELECTROHOME ELECTRONICS  
A DIVISION OF CENTRAL ONTARIO TELEVISION LIMITED  
A WHOLLY OWNED SUBSIDIARY OF ELECTROHOME LIMITED, KITCHENER, ONTARIO, CANADA N2G 4J6

# TABLE OF CONTENTS

Description	Page
Models .....	3
Notes .....	4
Service Data Reference .....	5
Warnings .....	5
Operating Instructions .....	5
Performance and Operating Data .....	6
Product Safety .....	7
Service Guidelines .....	7
Service Set-Up Procedure .....	8
C.R.T. PCB Component Layout .....	11
Main PCB Component Layout .....	12
Schematic .....	13
Replacement Parts .....	14
Main PCB Assembly .....	15
CRT Socket PCB Assembly .....	17

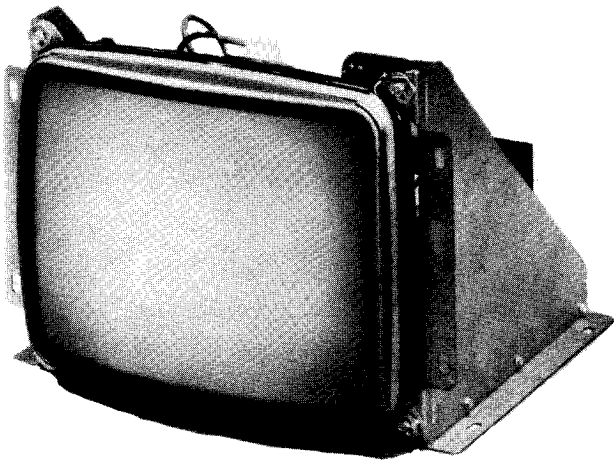

FRONT

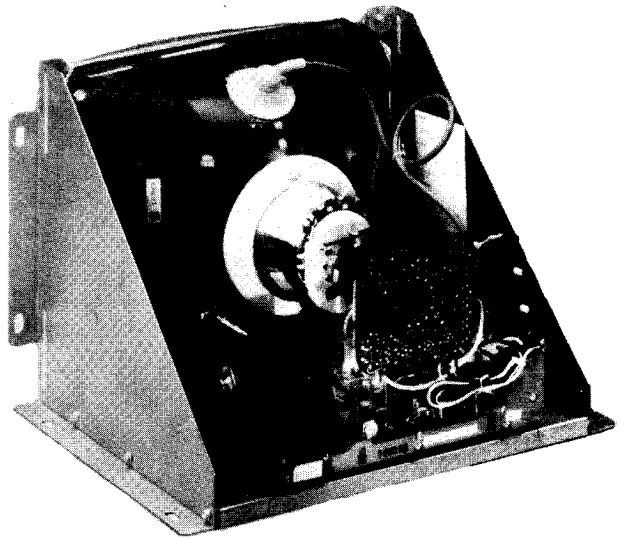

REAR

**G07-902**

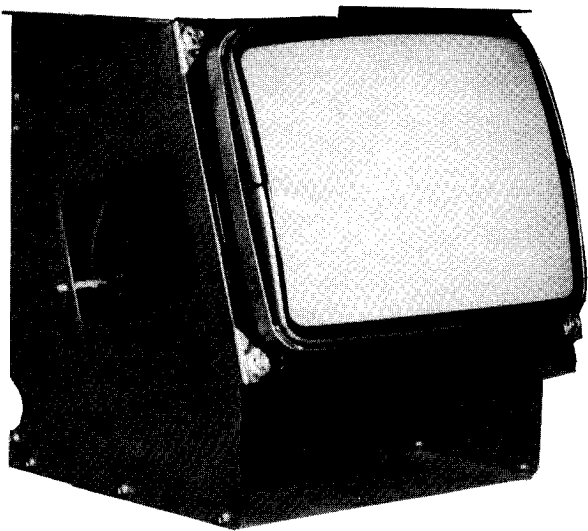

FRONT

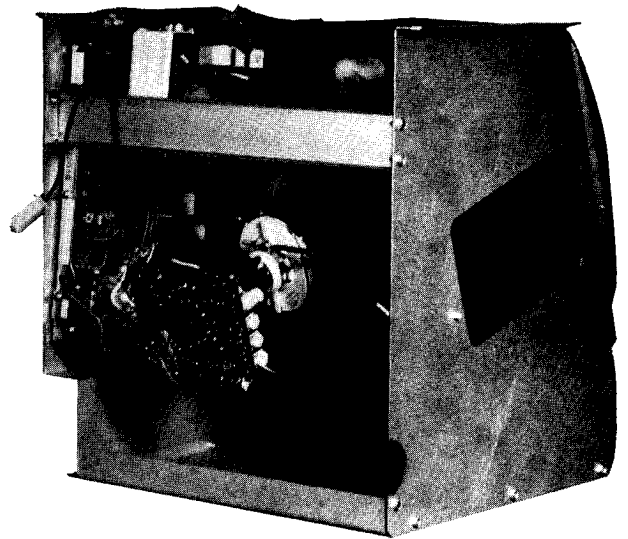

REAR

**G07-906**

## Service Data Reference

When writing for Service Information, please quote chassis type number and model code. See chassis type number and model code located on the right hand side panel.  
This information is correct as of May 1980.

**File Supplementary Model Data with this G07 Manual.**

### Warnings

#### 1. Power Up Warning

Caution: If the monitor is to be powered up outside of the games console, an isolation transformer must be used for the AC power source.

#### 2. X-Radiation

This chassis has been designed for minimal x-radiation hazard. However, to avoid possible exposure to soft x-radiation it is IMPERATIVE that the EHT circuitry IS NOT modified.

#### 3. High Voltage



The colour monitor contains HIGH VOLTAGES derived from power supplies capable of delivering LETHAL quantities of energy. To avoid DANGER TO LIFE, do not attempt to service the chassis until all precautions necessary for working on HIGH VOLTAGE equipment have been observed.

#### 4. CRT Handling

The picture tube encloses a high vacuum and due to the large surface area is subject to extreme force. Care must be taken not to bump or scratch the picture tube as this may cause the tube to implode resulting in personal injury and property damage. Shatter-proof goggles must be worn by individuals while handling the CRT or installing it in the monitor. Do not handle the CRT by the neck.

#### 5. To prevent fire or shock hazard DO NOT EXPOSE THIS MONITOR TO RAIN OR MOISTURE.

### Operating Instructions

1. Apply a suitable power source to the monitor through an isolation transformer by means of P901.
2. Apply a suitable signal source to the monitor PCB by mean of J201.
3. For negative input pulses use J202 D21 for vertical  . D3 for Horizontal  .
4. Set up Controls  
All controls are preset at the factory, but may be adjusted to suit program material. Refer to pages 6 and 8 (WHITE BALANCE AND GRAY SCALE TRACKING).

## Performance and Operating Data

### 1.0 Supply

**Min — Max**

Voltage

108 VAC - 132 VAC

Frequency

44 Hz - 63 Hz

Note: Apply supply voltage through an isolation transformer with 1 Amp. capability

### 2.0 High voltage (EHT)

For 13" V Models

19.5 KV - 22.5 KV

Note: Condition for above 1 (beam) = 0  
B<sub>1</sub> = 120V

### 3.0 Input Signal and Pin Assignments for J201

Pin No.	Description	Impedance	Signal Range
1	Red input	5K nom.	0 to 4V
2	Green input	5K nom.	0 to 4V
3	Blue input	5K nom.	0 to 4V
4	Ground		
5	Vertical sync pulse	35K nom.	+2V to +4V
6	Horizontal sync pulse	35K nom.	+2V to +4V

### 4. Service Set-Up Controls

- 4.1 Vertical linearity R406
- 4.2 Vertical Height R408
- 4.3 Vertical hold control, R422
- 4.4 Horizontal Freq. control, R504
- 4.5 Horizontal centering tabs, 3 positions
- 4.6 Vertical centering tabs, 3 positions
- 4.7 CRT cut off controls (See fig. 3)
  - Red cut off, R114
  - Green cut off, R115
  - Blue cut off, R113
- 4.8 Video drive controls (See fig. 3)
  - Red drive, R105
  - Green drive, R106
- 4.9 Focus control R11 and screen control

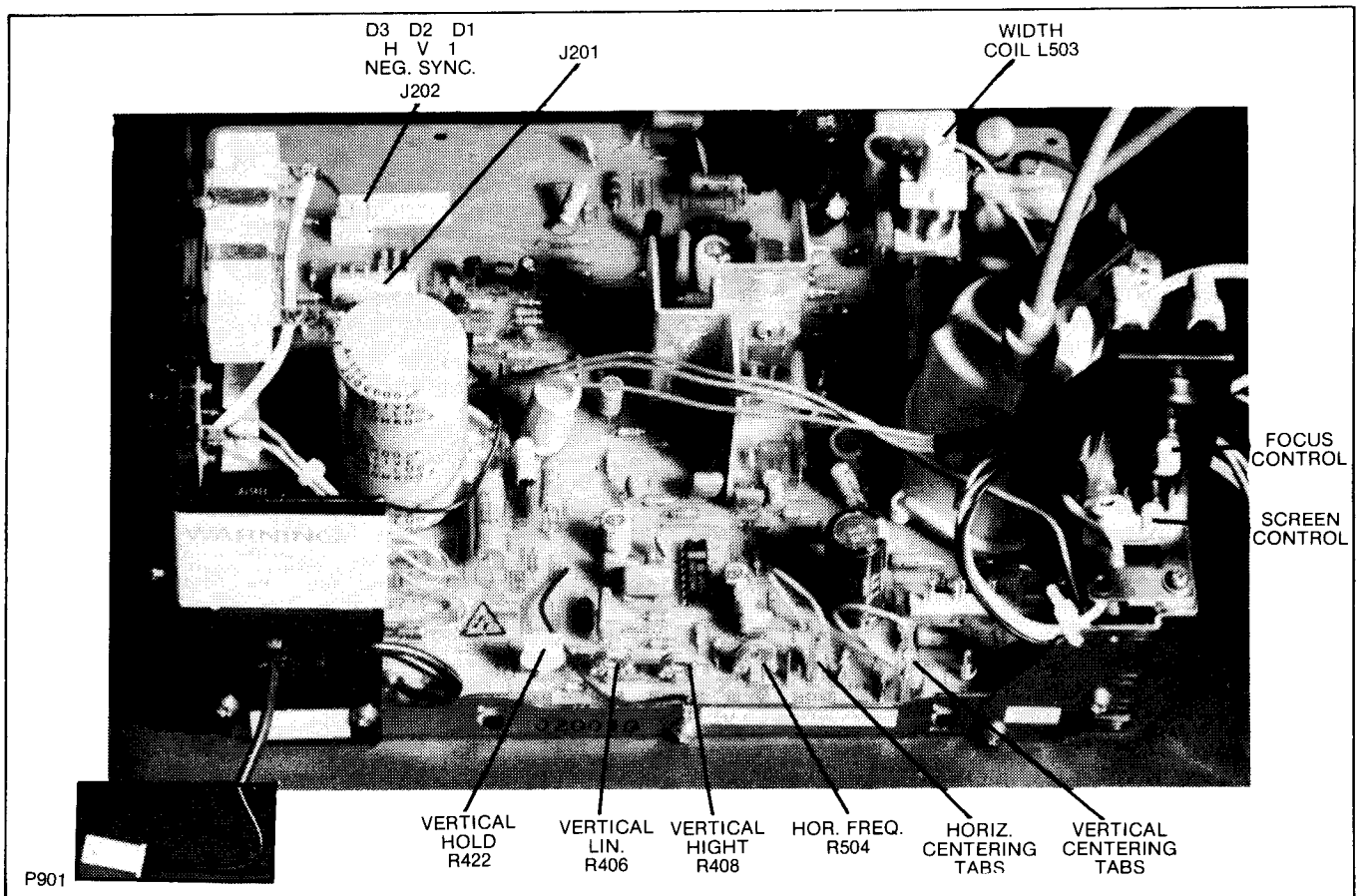

## Product Safety and Servicing Guidelines

### Safety Checks

Subject: Fire and Shock Hazard

1. No modification of any circuit should be attempted. Service work should be performed only after you are thoroughly familiar with all of the following safety checks and service guidelines. To do otherwise increases the risk of potential hazards and injury to the user.
2. When service is required, observe the original lead dress. Extra precaution should be given to assure correct lead dress in the high voltage circuitry area. Where a short circuit has occurred, replace those components that indicate evidence of overheating. Always use the manufacturer's specified replacement component. See parts list in the back of this manual.
3. Periodically check the high voltage for proper value using a meter of known accuracy and calibration.
4. Check for frayed insulation on wires.

### Notes

# Service Set-Up Procedure

**NOTE:** All monitors are equipped with automatic degaussing coils which effectively demagnetize the picture tube each time the monitor is turned on. The degaussing coils will operate any time the set is turned on after having been off for at least five minutes.

The degaussing effect is confined to the picture tube since the coils are mounted on the ferrous tube shield. Should any part of the chassis or cabinet become magnetized, it will be necessary to degauss the affected area by means of a manual degaussing coil. Move the coil slowly around the CRT face area, then slowly withdraw for a distance of six feet before disconnecting the coil from the AC power supply.

Normally little, if any adjustment should be necessary. However, when a picture tube, yoke or similar component is replaced, preliminary static convergence should be done before attempting purity adjustment, and so on.

Set up should be done in a north/south direction. Horizontal and vertical centering taps should be set to the centre position if a major component has been changed.

## 1.0 Purity

- 1.1 Loosen yoke retaining clamp (figure 2), remove adhesive material fixing wedges to CRT. Remove wedges completely and clean off dried adhesive from picture tube and wedges.
- 1.2 A small quantity of "nail polish" has been used to lock the purity convergence rings in place. This seal must be broken with a sharp tipped instrument before any adjustments are attempted. Some models also use a locking ring at either end of the purity and convergence rings. This must be loosened before adjustments are made. It goes without saying that upon completion of all adjustments, the lock must be reset and/or a dab of paint or nail polish must be re-applied to edge of rings to prevent movement.
- 1.3 Connect an appropriate signal source, eg: Electro-home RGB generator producing a white field plus individual red, green and blue fields.
- 1.4 Bring the long and short purity tab protrusions in line with each other to obtain near-zero magnetic field (figure 4) (In some cases bring the flat and indented tabs together to obtain zero field). Protrusions can then be vertical, horizontal or at any convenient angle to start.
- 1.5 Turn off the green and blue fields and adjust setup controls to produce a red field. (See fig. 3)
- 1.6 Pull the deflection yoke back so that a red band appears in the centre of the screen.
- 1.7 Spread the tabs apart as little as necessary and rotate both rings together to center the red band horizontally on the face of the CRT (approximate). (See Fig. 5)
- 1.8 Slide the yoke towards the bell of the picture tube slowly to obtain a uniform red field (pure in color) across the entire tube face. Juggle back and forth slightly as necessary. Lightly tighten yoke retaining clamp.
- 1.9 Momentarily switch on a cross-hatch signal and rotate yoke to level the pattern on the face of CRT.
- 1.10 Return generator to regain red raster.
- 1.11 Turn off red field and check for pure field for each of the green and blue fields. Reposition yoke if necessary to obtain optimum purity on all fields.
- 1.12 Tighten yoke retaining clamp to prevent yoke shift or rotation. (Do not install wedges at this time.)

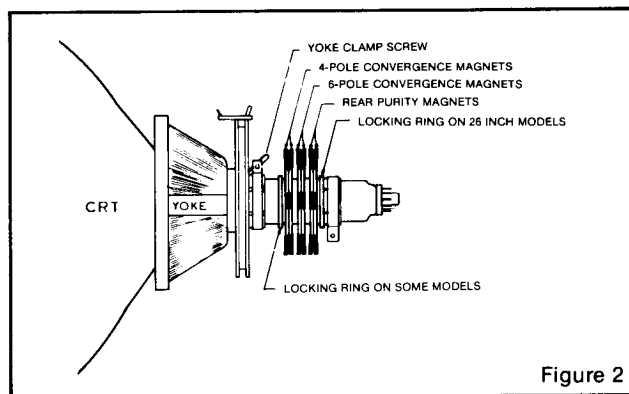

Figure 2

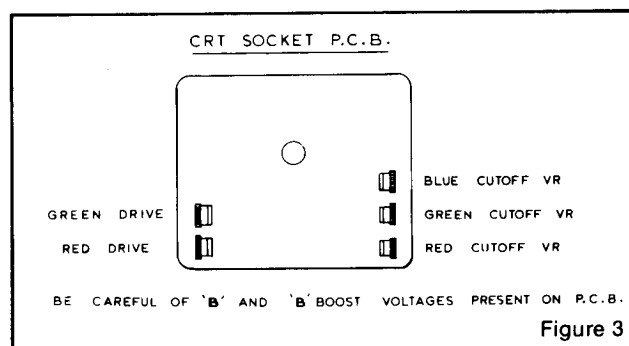

Figure 3

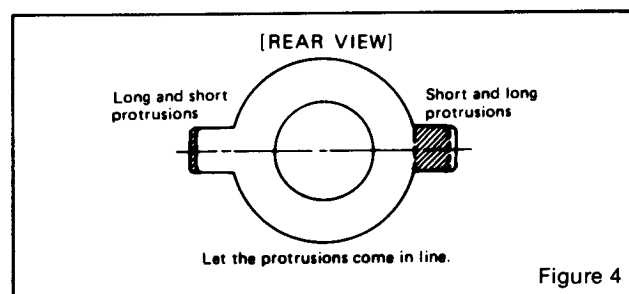

Figure 4

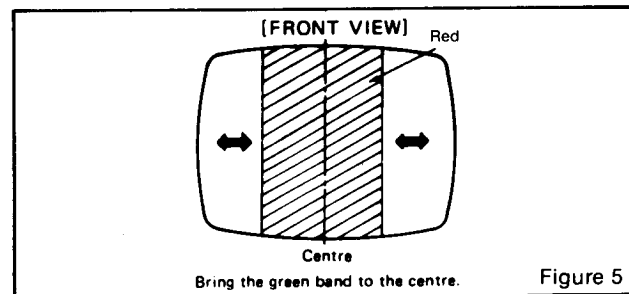
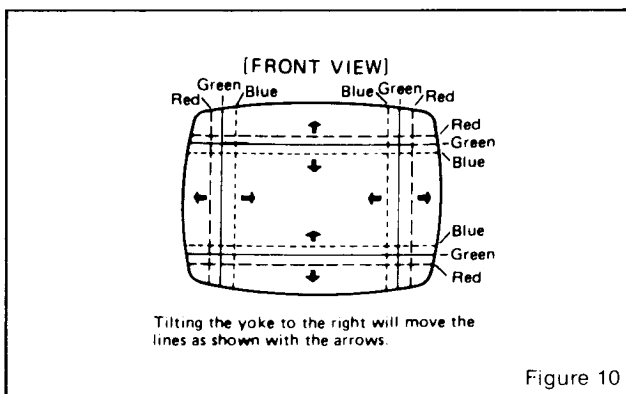
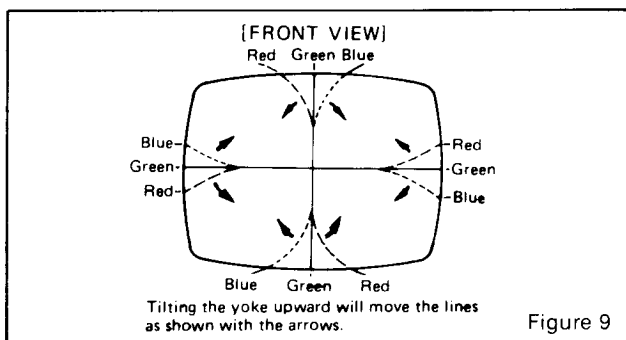
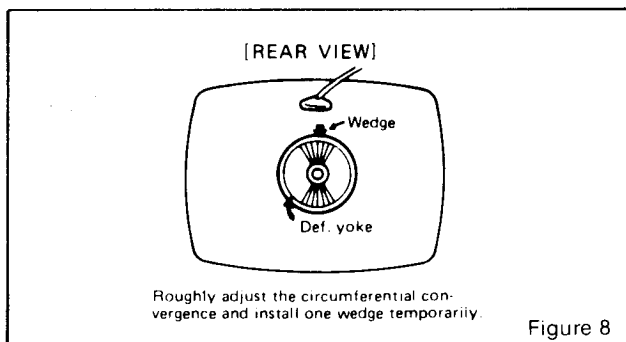
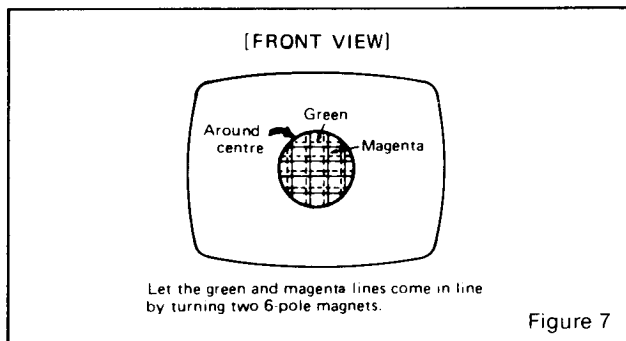
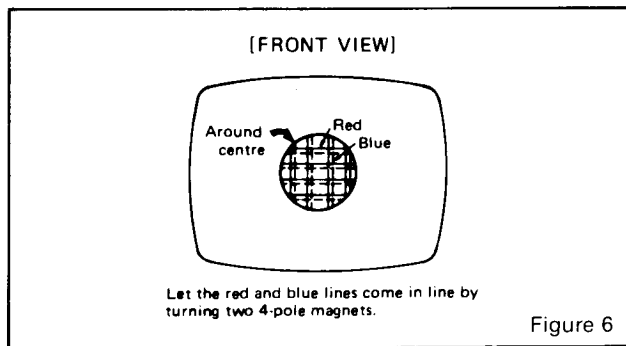

Figure 5

## 2.0 Static and Dynamic Convergence

NOTE: Static convergence is achieved by four magnets located on the neck, nearest the base of the picture tube, Fig. 2. The middle pair of magnetic rings are adjusted to converge the blue and red crosshatch lines. The rear pair of convergence rings (closest to the base of the picture tube) are adjusted to converge the magenta (blue/red) to the green crosshatch lines. Dynamic convergence is achieved by tilting the deflection yoke up-down and left-right.

- 2.1 Ensure that the controls misadjusted during purity setup (screen, cut-off, etc.) are set to give white balance. See 3.0 below.
  - 2.2 Switch generator to the crosshatch pattern.
  - 2.3 Adjust convergence around the edges of the picture tube by tilting the yoke up-down and left-right, and temporarily install one wedge at the top of the yoke or in a more optimum position. (Figures 8, 9, 10)
  - 2.4 Turn off green input and turn on the red and blue input.
  - 2.5 Rotate the 4-pole (middle) pair of magnets as a unit to minimize separation of the red and blue crosshatch lines around the center of the screen (Figure 6). Variation of the angle between the tabs adjusts convergence of red and blue. (Tilt yoke as required to converge red and blue at the edges as in 2.3 above.)
  - 2.6 Turn on green input to obtain magenta (red/blue) and green crosshatch lines. Rotate the 6-pole (rear) pair of magnets as a unit to minimize separation of the magenta and green lines (figure 7). Vary angle between the two tabs and further rotate as a unit to finalize.
  - 2.7 When convergence of 3 colors is optimized (static in center and dynamic around edges) apply stripe of paint or nail polish to convergence magnet rings to prevent movement. If applicable, tighten locking ring carefully.
  - 2.8 Remove temporary wedge from yoke. Tilt yoke in up-down and left-right direction for best circumference convergence and install 3 wedges. (It is best to use 3 new wedges since they have adhesive backing. Simply pull off tape, slide wedge in place and press outer flap down firmly. For more permanency apply small quantity of silastic or similar material at junction of wedges and picture tube. Do not disturb while material is setting. (Order wedges by part number 39-1233-01).
- ### 3.0 White Balance (Grey Scale Tracking)
- Refer to figure 3. Do the following in subdued light:
- 3.1 Note this adjustment can be accomplished with no signal connected; eg: input connector open or if a signal generator is connected, switch off all 3 inputs at the generator.
  - 3.2 Set red and green drive controls to their mechanical center and turn the common G2 screen control and 3 cut-off controls to minimum (fully counterclockwise).
  - 3.3 Slowly turn up G2 screen control until the first faint color appears, then back off to edge of visibility. Do not touch the associated cut-off control - it should stay fully CCW for the remaining set-up.
  - 3.4 Slowly turn up the other two color cut-off controls in turn to match the first. This should result in the faintest grey.
  - 3.5 Turn on the signal generator with all 3 inputs on. (a crosshatch pattern would be appropriate).





- 3.6 Adjust the red and green drive controls for "neutral white" on high white picture areas. Generally these controls will be left at mech. centre.
- 3.7 Note: When monitor is re-connected with the game the screen control (G2) may require a slight adjustment to obtain proper black level. (the black portion of picture just extinguished).

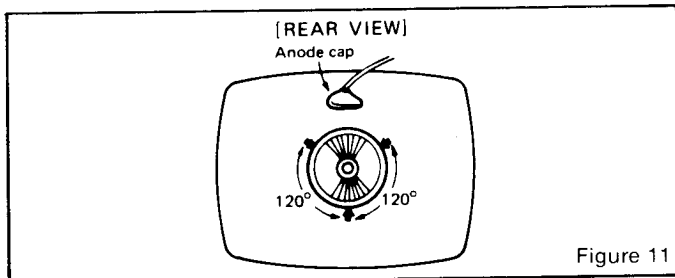

Figure 11

#### 4.0 Focus

Adjust focus control for best overall definition and picture detail an average signal applied. (Highlights should be favoured.)

#### 5.0 Color Service Generator for G07 Monitor

Electrohome has developed a color service generator that is specifically designed for use with the G07 color data monitor. It provides the monitor with both horizontal and vertical sync, as well as the following test patterns:

- 1) Fine cross-hatch pattern
- 2) Broad bar cross-hatch pattern
- 3) Complete field

Three color selection switches, red, green and blue, provide the ability to display the above patterns in the three primary colors as well as the three secondary colors.

This product may be ordered from:

Contracts Marketing  
 ELECTROHOME Electronics  
 809 Wellington St. North  
 Kitchener, Ontario  
 Canada N2G 4J6  
 Telephone: (519) 744-7111, Ext. 567



#### 6.0 X-Ray Emission Check

- 6.1 Assure that the anode voltage does not exceed max. as per Item 2.0 page 4.
- 6.2 Assure that the high voltage hold down circuit is operating correctly. Use the following procedure.
  - a) Increase the B1 greater than 138.5V by shorting collector/emitter of the power regulator, X04.
  - b) Observe that the anode voltage (EHT) goes to 0. If the EHT does not go to 0, a fault must be located and repaired.
  - c) Remove short and set should return to normal operation. (Note, after the short is removed some monitors may not restart. In this case, remove power from monitor momentarily and normal operation will be restored.

Note:

The protector circuit consists of the components shown below in Fig. 13 with a circuit description.

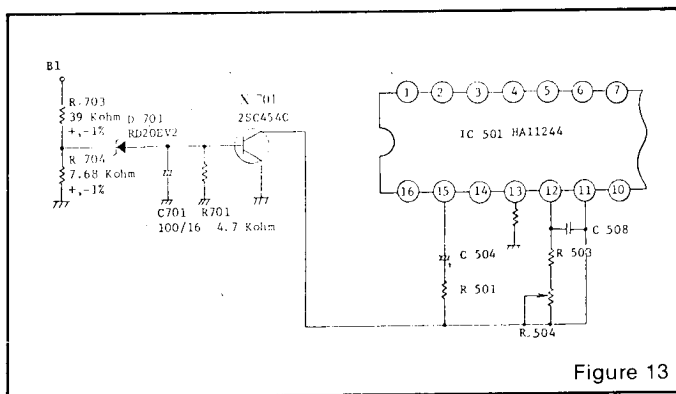

Figure 13

#### 7.0 Circuit Diagram and Description of High Voltage Hold Down or Safety Circuit

- 7.1 Circuit Diagram of High Voltage Hold Down Circuit.
- 7.2 Operation of High Voltage Hold Down Circuit.

The high voltage hold-down circuit protects the high voltage circuit from dangerous voltage with short circuiting between emitter and collector of power regulating transistor.

The base voltage of X701 is increased when the B1 voltage is increased more than 138.5 V DC.

When the base of X701 is increased, a short is produced by X701 between pin 11 and ground of IC 501, shutting down the horizontal osc. and high voltage.

# C.R.T. P.C.B. COMPONENT LAYOUT

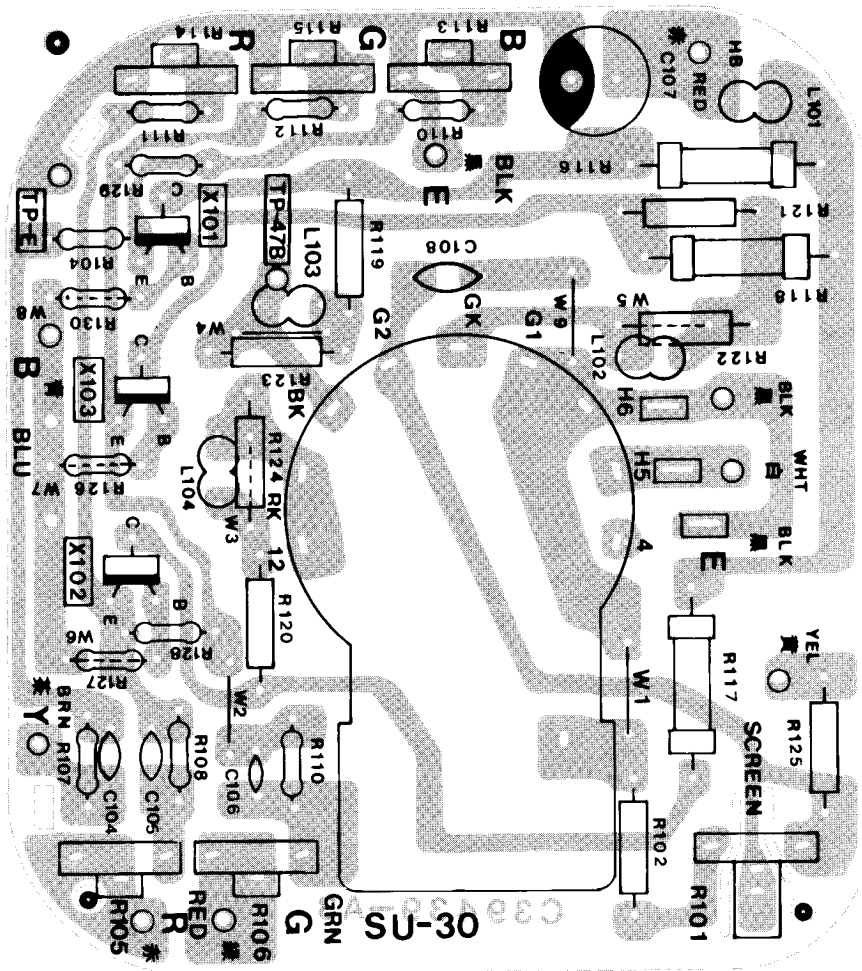

Notes:

00-18025-04



IC01 POWER REGULATOR  
STR383

### SU-1103A MAIN PCB ASSY

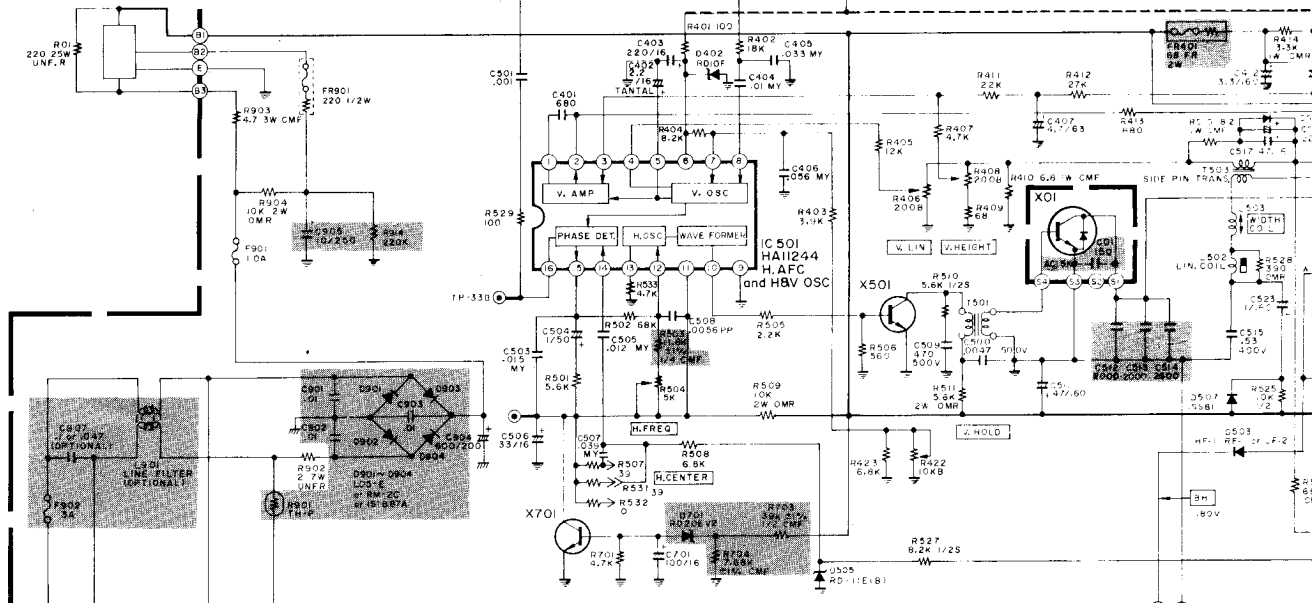

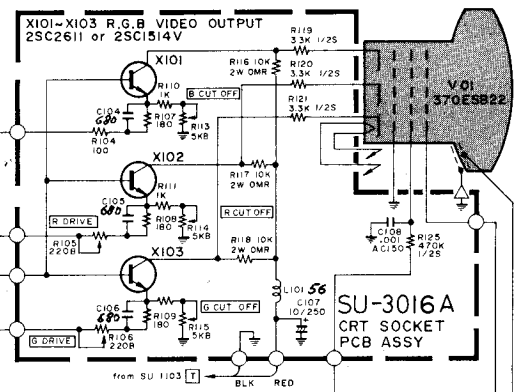
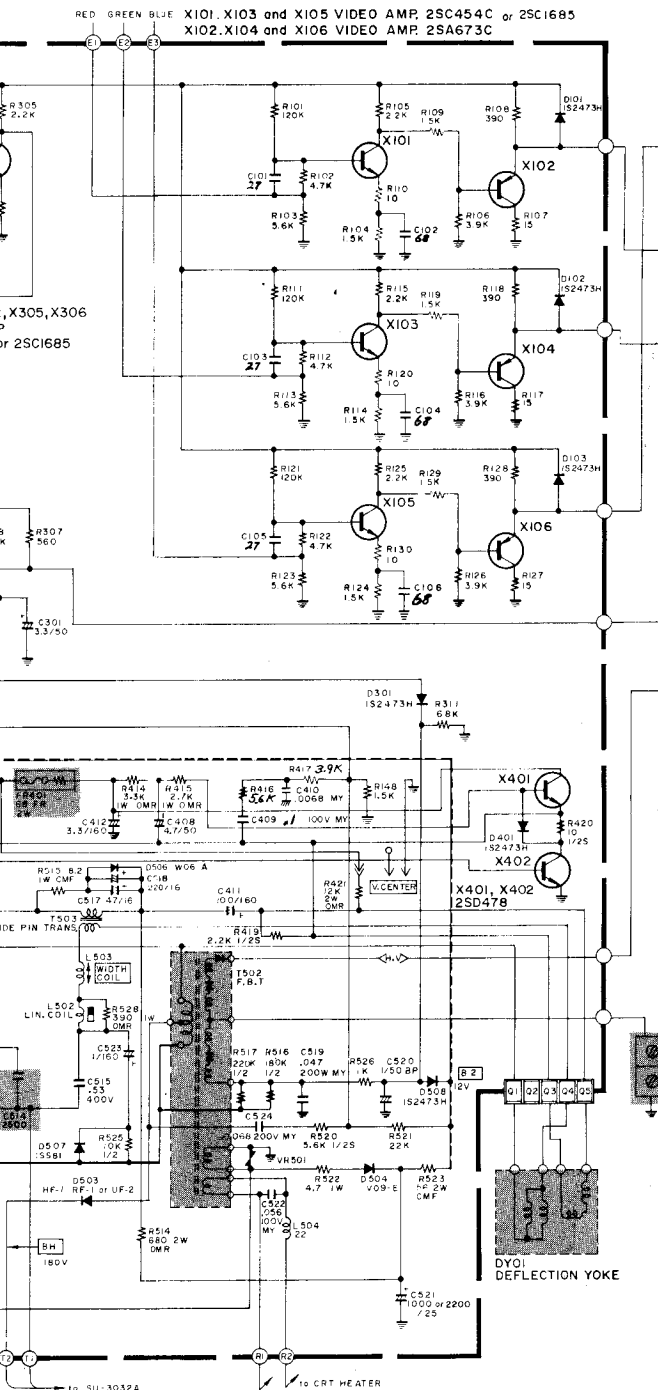

**Schematic Notes**

- Unless otherwise specified
- Resistance: ( $\Omega$ ) (K $\rightarrow$ K $\Omega$ , M $\rightarrow$ M $\Omega$ ), 1/4 (W) carbon resistor
- Capacitance: 1 or higher  $\rightarrow$  (pF), less than 1  $\rightarrow$  ( $\mu$ F)
- working voltage  $\rightarrow$  50 (V)
- ceramic capacitor
- Inductance: ( $\mu$ H)
- Electrolytic Cap: Capacitance Value ( $\mu$ F)/working voltage (V), NP  $\rightarrow$  non-polar (or bipolar) electrolytic cap.
- Refer to the parts list for additional component information.
- $\odot$  indicates test point connection
- $\perp$  indicates chassis ground unless otherwise specified
- Hz indicates cycles per second
- For **safety** purposes (and continuing reliability)
- $\triangle$  replace all components marked with safety symbol with identical type.
- NOTE: FR  $\rightarrow$  fusible resistor ( $\leftarrow$   $\rightarrow$ )

G07-FBO  
 00-4147-03

Parts identification on circuit boards:  
 e.g. SU1126A (R107 = R1107)  
 SU3030A (R113 = R3113)

# REPLACEMENT PARTS LIST

Components identified by the  $\Delta$  symbol in the PARTS LIST and on the Schematic have special characteristics important to safety.

DO NOT degrade the safety of the set through improper servicing.

## Abbreviations for Resistors and Capacitors

### Resistor

C R	: Carbon Resistor
Comp. R	: Composition Resistor
OM R	: Oxide Metal Film Resistor
V R	: Variable Resistor
MF R	: Metal Film Resistor
CMF R	: Coating Metal Film Resistor
UNF R	: Nonflammable Resistor
F R	: Fusible Resistor

### Capacitor

C Cap.	: Ceramic Capacitor
M Cap	: Mylar Capacitor
E Cap.	: Electrolytic Capacitor
BP E Cap.	: Bi-Polar (or Non-Polar) Electrolytic Capacitor
MM Cap.	: Metalized Mylar Capacitor
PP Cap.	: Polypropylene Capacitor
MPP Cap.	: Metalized PP Capacitor
PS Cap	: Polystyrol Capacitor
Tan. Cap.	: Tantal Capacitor

NOTE: When ordering replacement parts please specify the part number as shown in this list including part name, and model number. Complete information will help expedite the order.

Use of substitute replacement parts which do not have the same safety characteristics as specified, may create shock, fire or other hazards. For maximum reliability and performance, all parts should be replaced by those having identical specifications.

Symbol	Description	Part Number
	Main P.C.B. Ass'y	SU-1103A
	CRT Socket P.C.B. Ass'y	SU-3016A

### Outside of the P.C.B. Ass'y

Symbol	Description	Part Number
$\Delta$ V01	$\Delta$ Picture Tube	370ESB22(E)
$\Delta$ DY01	$\Delta$ Deflection Yoke	C29123-V
	PC Magnet	A76366-A
	Wedge	C30006
	$\Delta$ Flyback Transf.	A19183-A
$\Delta$ R11	$\Delta$ Focus V R	A46606-A
$\Delta$ R05	UNF Resistor 220 $\Omega$ , 25W. K	QRF258K-221
$\Delta$ C04	$\Delta$ C Capacitor 150 pF, AC1.5KV	QCZ0101-005
X01	Si. Transistor	2SD869
IC01	IC Regulator	STR383
L01	Degaussing Coil	21-1007-31
	Degaussing Coil Pin Terminal (2)	34-708-01
	Degaussing Coil Pin Terminal Housing	34-709-01
	Groundstrap Ass'y.	34-697-04
	Groundstrap Wire Terminal	34-228-03
	Groundstrap Spring (2)	35-3560-01
BR	Support Bracket RH	35-3919-01
BR	Support Bracket LH	35-3919-02
SC	SCREW 10- $\frac{1}{2}$ Pix Tube Mtg. (4)	31-631018-08
WA	Pyramidal Lockwasher (4)	33-255-01
	Clip P.C.B. Support (2)	33-629-02
	Ground Lug	34-33-04
CH	Chassis Base	38-452-01

# Main P.C.B. Ass'y (SU-1103A) Parts List

## Resistors

Symbol	Description	Part Number
R1406	V R 200 $\Omega$	QVZ3230-022
R1408	V R 200 $\Omega$	QVZ3230-022
R1410	CMF R 6.8 $\Omega$ 1W J	QRX019J-6R8
R1414	OM R 3.3K $\Omega$ 1W J	QRG019J-332
R1415	OM R 2.7K $\Omega$ 1W J	QRG019J-272
R1421	OM R 12K $\Omega$ 2W J	QRG029J-123
R1422	V R 10K $\Omega$	QVZ3224-014H
$\Delta$ FR1401	$\Delta$ F R 68 $\Omega$ 2W K	QRH024K-680M
$\Delta$ R1503	$\Delta$ CMF R 11.8K $\Omega$ $\frac{1}{4}$ W +1%	QRV142F-1182
R1504	V R 5K $\Omega$	QVZ3230-053
R1509	OM R 10K $\Omega$ 2W J	QRG029J-103
R1511	OM R 5.6K $\Omega$ 2W J	QRG029J-562
R1514	OM R 680 $\Omega$ 2W J	QRG029J-681
R1515	CMF R 8.2 $\Omega$ 1W J	QRX019J-8R2
R1522	CMF R 4.7 $\Omega$ 1W J	QRX019J-4R7
R1523	OM R 56 $\Omega$ 2W J	ORG029J-560
R1528	OM R 390 $\Omega$ 1W J	ORG019J-391
R1534	ZN R	ERZ-C05ZK471
VR1501	ZN R	ERZ-C05DK271
$\Delta$ R1703	$\Delta$ CMF R 39K $\Omega$ $\frac{1}{2}$ W +1%	QRV122F-3902
$\Delta$ R1704	$\Delta$ CMF R 7.68K $\Omega$ $\frac{1}{4}$ W +1%	QRV142F-7681
$\Delta$ R1901	$\Delta$ Posistor	A75414
R1902	UNF R 2 $\Omega$ 7W K	QRF076K-2R0
R1903	CMF R 5.6 $\Omega$ 3W J	QRX039J-5R6
R1904	OM R 10K $\Omega$ 2W J	QRG026J-103Z
$\Delta$ FR1901	$\Delta$ F R 220 $\Omega$ $\frac{1}{2}$ W K	QRH124K-221M

## Capacitors

Symbol	Description	Part Number
C1402	Tan. Cap. 2.2uF 16V K	QEE51CK-225B
C1411	E Cap. 100uF 160V A	QEW52CA-107
C1412	E Cap. 3.3uF 160V A	QEW52CA-335
C1508	PP Cap. 5600pF 50V J	QFP31HJ-562
C1511	E Cap. 47uF 160V A	QEW52CA-476S
$\Delta$ C1512	$\Delta$ PP Cap. 2000pF DC1500V J	QFZ0082-202
$\Delta$ C1513	$\Delta$ PP Cap. 2000pF DC1500V J	QFZ0082-202
$\Delta$ C1514	$\Delta$ PP Cap. 2500pF DC1500V J	QFZ0082-252
C1515	PP Cap. 0.53uF DC1200V K	QFZ0067-534
C1520	BPE Cap. 1uF 50V A	QEN61HA-105Z
C1524	M Cap. 0.1uF 200V K	QFM72DK-682M
C1904	E Cap.	QEY0034-001
C1905	E Cap. 10uF 250V A	QEW52EA-106
$\Delta$ C1907	$\Delta$ MM Cap. 0.1uF AC150V Z	QFZ9008-104

## Coils

Symbol	Description	Part Number
L1501	Peaking Coil	A75360-6
L1502	Liniarty Coil	A39934
L1503	Width Coil	C30380-A
L1504	Heater Choke	C30333-A
L1901	Line Filter	A39475-J

## Transformers

Symbol	Description	Part Number
T1501	Hor. Drive Transf.	A46022-BM
T1503	Side Pin Transf.	C39050-A

**Semiconductors**

<b>Symbol</b>	<b>Description</b>	<b>Part Number</b>
IC1501	I.C.	HA11244
X1101	Si. Transistor	2SC1685(R)
X1102	Si. Transistor	2SA673(C)
X1103	Si. Transistor	2SC1685(R)
X1104	Si. Transistor	2SA673(C)
X1105	Si. Transistor	2SC1685(R)
X1106	Si. Transistor	2SA673(C)
X1301	Si. Transistor	2SC1685(R)
X1302	Si. Transistor	2SC1685(R)
X1303	Si. Transistor	2SA673(C)
X1304	Si. Transistor	2SC1685(R)
X1305	Si. Transistor	2SC1685(R)
X1401	Si. Transistor	2SD478
X1402	Si. Transistor	2SD478
X1501	Si. Transistor	2SC2610BK
X1701	Si. Transistor	2SC1685(P-S)
D1101	Si. Diode	W06A
D1102	Si. Diode	W06A
D1103	Si. Diode	W06A
D1301	Si. Diode	1S2473H
D1401	Si. Diode	1S2473H
D1402	Zener Diode	RD10F(C)
D1503	Si. Diode	HF-1
D1504	Si. Diode	V09E
D1505	Zener Diode	RD11E(B)
D1506	Si. Diode	W06A
D1507	Si. Diode	1SS81
D1508	Si. Diode	1S2473H
△D1701	△Zener Diode	RD20EV2
△D1901	△Si. Diode	1S1887A
△D1902	△Si. Diode	1S1887A
△D1903	△Si. Diode	1S1887A
△D1904	△Si. Diode	1S1887A

**Miscellaneous**

<b>Symbol</b>	<b>Description</b>	<b>Part Number</b>
△F1901	△Fuse 1A	QMF53U1-1R0S
△F1902	△UL Fuse 3A	QMF66U1-3R0S



# CRT Socket P.C.B. Ass'y (SU-3016A) Parts List

## Resistors

Symbol	Description	Part Number
R3105	V R 200Ω	QVZ3234-022
R3106	V R 200Ω	QVZ3234-022
R3113	V R 5KΩ	QVZ3234-053
R3114	V R 5KΩ	QVZ3234-053
R3115	V R 5KΩ	QVZ3234-053
R3116	OM R 10KΩ2W J	QRG029J-103
R3117	OM R 10KΩ2W J	QRG029J-103
R3118	OM R 10KΩ2W J	QRG029J-103
R3119	Comp. R 3.3KΩ½W K	QRZ0039-332
R3120	Comp. R 3.3KΩ½W K	QRZ0039-332
R3121	Comp. R 3.3KΩ½W K	QRZ0039-332

## Capacitors

Symbol	Description	Part Number
C3107	E Cap. 10uF 250V A	QEW52EA-106
C3108	C Cap. 1000pF DC1400V P	QCZ9001-102M

## Coils

Symbol	Description	Part Number
L3101	Peaking coil	QQL043K-101

## Semiconductors

Symbol	Description	Part Number
X3101	Si. Transistor	2SC2611
X3102	Si. Transistor	2SC2611
X3103	Si. Transistor	2SC2611

## Miscellaneous

Symbol	Description	Part Number
△	△ CRT Socket	A75522