

Amplifone High-Voltage PCB

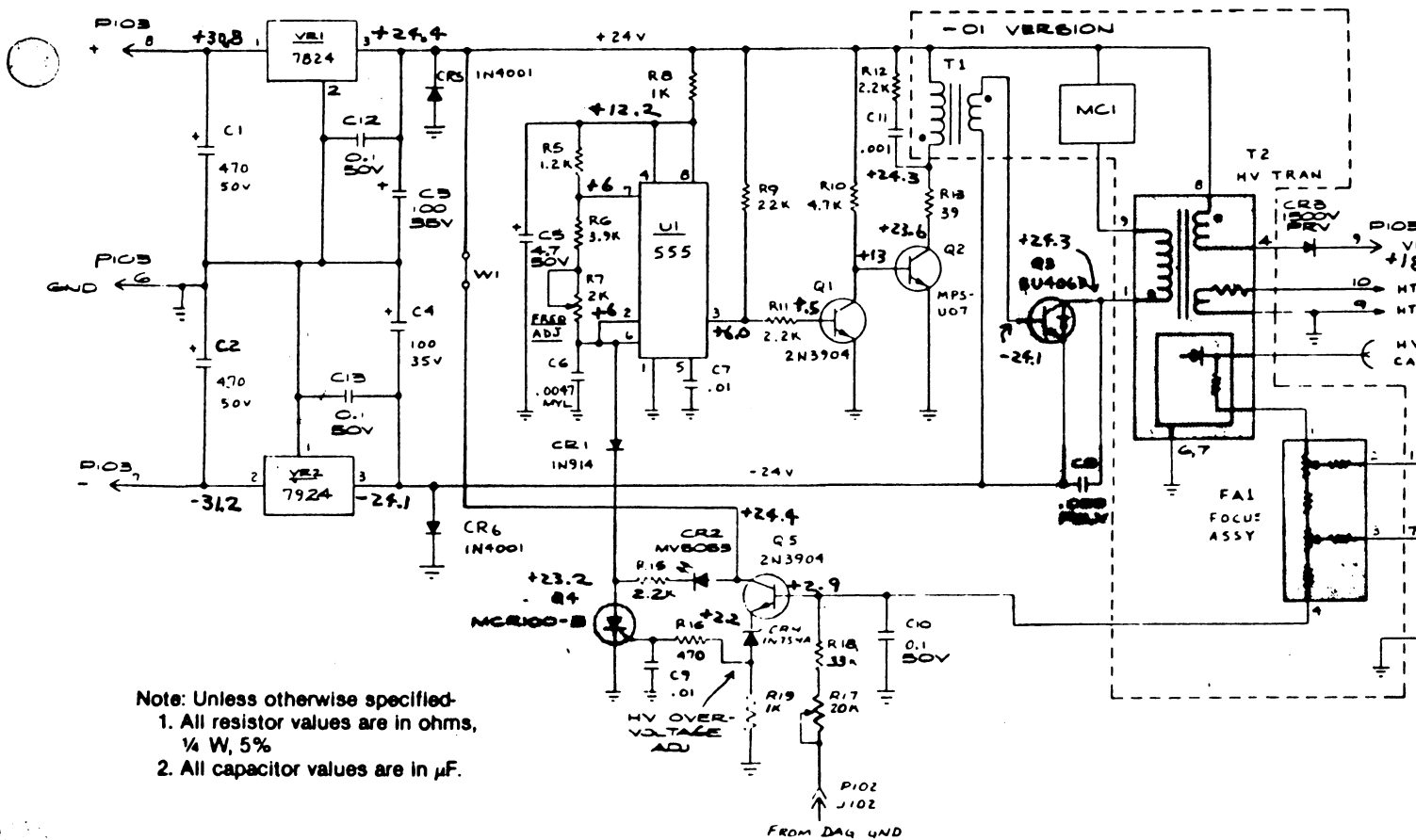

Note: Unless otherwise specified:
 1. All resistor values are in ohms, 1/4 W, 5%
 2. All capacitor values are in μ F.

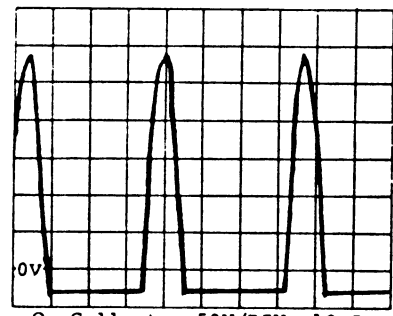

Q₃ Collector 50V/DIV. 10uS

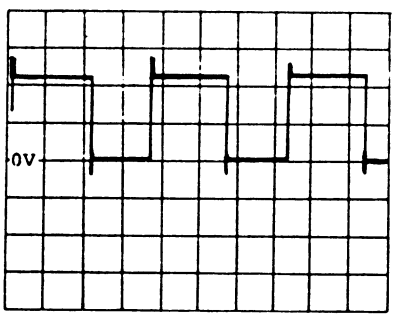

555 Pin 3 5V/DIV. 10uS

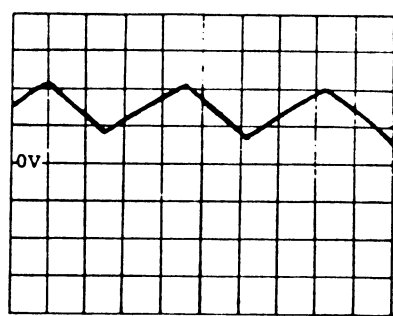

555 Pin 2 5V/DIV. 10uS

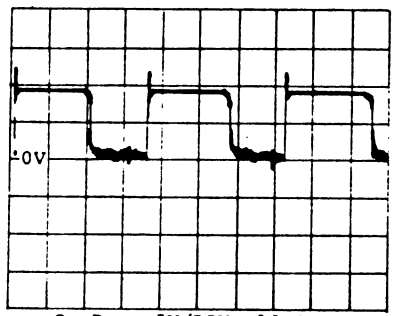

Q₁ Base 5V/DIV. 10uS

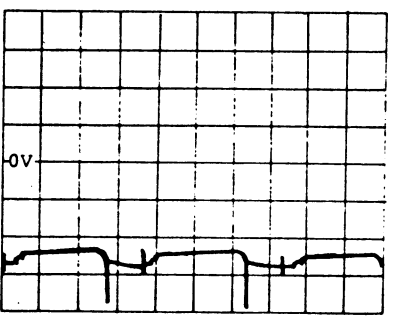

Q₃ Base 10V/DIV. 10uS

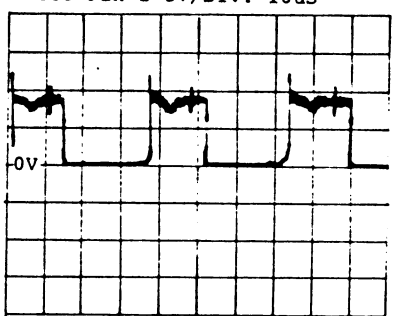

Q₁ Collector 5V/DIV. 10uS

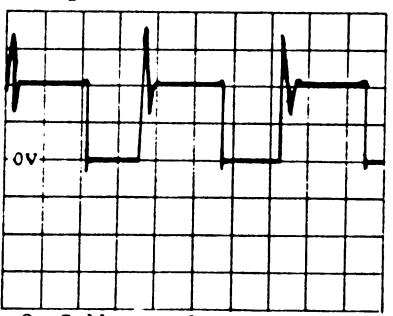

Q₁ Collector 20V/DIV. 10uS

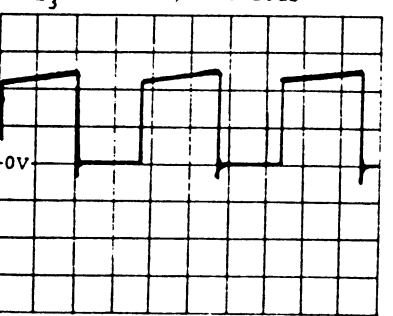

555 Pin 7 5V/DIV. 10uS

Q₃ Emitter is -24VDC

All schematic voltages are measured with a digital multimeter