



**SKEE-BALL, INC.**

121 Liberty Lane, Chalfont, PA 18914 • (215) 997-8900

**SINGLE PLAYER  
MODEL S**

**INSTRUCTIONS FOR:  
UNPACKING  
ASSEMBLY  
CHECK OUT  
MAINTENANCE  
AND  
TROUBLESHOOTING**

Skee-Ball • Seven Pin • Amusement Devices

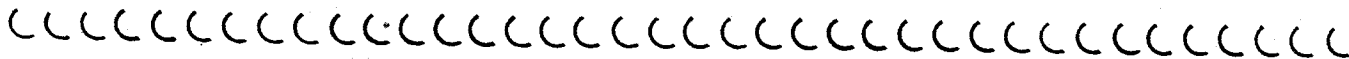

#### FCC INFORMATION

NOTE: This equipment has been tested and found to comply with the limits for a Class "A" digital device, pursuant to Part 15 of the FCC Rules. These limits are designed to provide reasonable protection against harmful interference when the equipment is operated in a commercial environment. This equipment generates, uses, and can radiate radio frequency energy and, if not installed and used in accordance with the instruction manual may cause harmful interference to radio communications. Operation of this equipment in a residential area is likely to cause harmful interference in which case the user will be required to correct the interference at his own expense.

## TABLE OF CONTENTS

INSTALLATION INSTRUCTIONS.....	1
UNPACKING.....	1
ASSEMBLY.....	1
PROGRAMMING THE CONTROLLER.....	3
DESCRIPTION OF SWITCHES.....	3
ENTERING MENU MODE.....	4
FUNCTIONAL DESCRIPTION.....	6
GAME PLAY.....	6
TICKET DISPENSER.....	6
ELECTRICAL.....	6
MECHANICAL.....	6
LOADING OF TICKETS.....	7
TD PD BOARD.....	7
ROLLER TENSION SPRING.....	7
TICKET GUIDE SPRING.....	7
TICKET STOP ADJUSTMENT.....	8
TROUBLESHOOTING CHART.....	9
TROUBLESHOOTING GUIDE.....	10
IMPROPER SCORING.....	10
IMPROPER BALL COUNT.....	10
NO SOUND.....	10
FAILS TO COIN UP.....	10
COUNTERS FAIL.....	10
LAMPS DO NOT LIGHT.....	10
"HELP" APPEARS IN DISPLAY.....	10
WARRANTY.....	11

## LIST OF FIGURES

BLOCK DIAGRAM OF ALLEY.....	A-1
WIRING HARNESS.....	A-2
SCHEMATICS.....	A-3
CPU, ROM, RAM, COUNTER.....	A-4
I/O, SWITCH INPUTS.....	A-5
SOUND, BALL RELEASE, FLASHER.....	A-6
POWER SUPPLY.....	A-7
DISPLAY.....	A-8

SKEE BALL, INC.  
INSTRUCTIONS FOR SINGLE PLAYER

INSTALLATION INSTRUCTIONS

A. UNPACKING CRATED ALLEYS.

CRATES SIZES APPX. 64 X 37 X 33: CONTAINS REAR CABINET, NET FRAMES, SUPPORTS, BALLS, ASSEMBLY FASTENERS, AND STEEL LEGS.  
21 X 122 X 31: CONTAIN FRONT RUNWAY.

B. PORTABLE ALLEYS MUST BE MATCHED BY SERIAL NUMBER LOCATED ON FRONT RUNWAY AND BACK CABINET.

C. STANDARD ALLEY ASSEMBLY.

1. FRONT RUNWAYS AND BACK CABINETS NEED NOT BE MATCHED.

2. REPOSITION THE BALL COUNT SWITCH MOUNTING BRACKET BY REMOVING THE TWO 1/4 X 20 X 1" MACHINE BOLTS FROM THE BALL COUNT SWITCH MOUNTING BRACKET WHICH HOLDS THE BRACKET TO THE FRONT BULKHEAD OF THE REAR CABINET IN THE NO SCORE FLOOR AREA. DO NOT UNPLUG THE CONNECTOR LEADING FROM THE WIRE HARNESS TO THE BALL COUNT SWITCH. AFTER THE TWO MACHINE BOLTS ARE REMOVED, SIMPLY TURN THE BRACKET AROUND AND REINSTALL THE BOLTS THROUGH THE SWITCH MOUNTING BRACKET AND BACK INTO THE PRETAPPED HOLES IN THE FRONT BULKHEAD OF THE REAR CABINET. ADJUST THE ACTUATING AREA OF THE SWITCH SO THAT THE BALLS STRIKE THE AREA AS THEY PASS THROUGH THE BALL RETURN OUTLET.

3. LAY BACK CABINET AND FRONT RUNWAY SIDWAYS. JOIN THE TWO USING 1/4" MACHINE BOLTS. BE SURE THE FACE OF THE JOINT IS FREE OF ANY PACKING MATERIAL WHICH WOULD PREVENT A TIGHT JOINT.

4. FASTEN STEEL SUPPORTS TO THE FRONT RUNWAY USING 3/8" BOLTS. T NUTS ARE ALREADY FASTENED TO THE RUNWAY TO RECEIVE THESE BOLTS. TIGHTEN TO MAKE SECURE.

5. TICKET AND LOCKING CHANNEL COVER ARE SHIPPED IN SEPARATE BOX. CONNECT WIRE HANESS ON TICKET DISPENSER TO MATCHING CONNECTOR ON LEFT SIDE OF ALLEY. LOAD TICKET DISPENSER WITH TICKETS. PLACE DISPENSER IN ALLEY MAKING SURE THAT REAR OF DISPENSER HOOKS OVER 3/4" POP SPREADER. INSERT TAB OF COVER UNDER FRONT OF ALREADY INSTALLED CHANNEL COVER. LOWER FRONT OF COVER INTO PLACE AND LOCK.

6. CAREFULLY LOOSEN CABLE TIE IN REAR CABINET AND PASS HARNESSES THROUGH OPENING OF CABINET. RUN HARNESS THROUGH FRONT RUNWAY AND CONNECT JUNCTION PLUGS.

7. INSERT TWO 1/4" SQUARE STEEL LEGS INTO SQUARE HOLES IN FLOOR OF EXTREME END OF REAR CABINET AND FASTEN WITH TWO 3/8 X 3" CARRIAGE BOLTS IN EACH LEG WITH NUTS ON INSIDE OF CABINET.

8. TO INSTALL THE LEG ON THE LOWER SIDE, WHICH IS ON THE FLOOR, IT WILL BE NECESSARY TO LIFT THE ALLEY AND SLIP A 3 OR 4" BLOCK UNDERNEATH IN ORDER TO GET CLEARANCE FROM THE FLOOR TO INSTALL THE BOLTS. BE SURE ALL FOUR NUTS ARE TIGHT BEFORE ATTEMPTING TO RAISE ALLEY UPRIGHT.

9. TWO MEN CAN NOW SET THE ALLEY UPRIGHT ON ITS SUPPORTS. ONE MAN SHOULD GRIP AND LIFT UNDER THE COVER ON TOP OF THE BACK CABINET AND THE OTHER SHOULD GRIP THE FRONT OF THE ASSEMBLED ALLEY TO FOLLOW THRU ON THE LIFT AND PREVENT UNDUE TWIST IN THE ALLEY AS IT IS LIFTED.

ALL ALLEYS SHOULD BE ASSEMBLED AND SET UPRIGHT BEFORE PROCEEDING WITH THE NET FRAME ASSEMBLY.

10. INSTALL FLASHER. SCREW THE FLASHER ONTO THE NIPPLE AND PLUG INTO THE POWER SUPPLY INSIDE CABINET.

11. NET FRAME ASSEMBLY. NETS ARE PACKED IN A SEPARATE BOX. THE NET FRAME ASSEMBLY CONSISTS OF THREE PARTS: TOP NET, LEFT SIDE NET, AND RIGHT SIDE NET (FRONT NET IF 10' OR ORDERED AS AN OPTION). PLACE SIDE NET ON ALLEY SO THAT THE PROTRUDING BOSS ON THE LOWER CASTING FITS INTO THE SLOT ON THE TOP OF THE CHANNEL COVER. INSTALL FLAT HEAD BOLTS INTO THE UPPER CASTING AND THRU THE REAR CABINET. INSTALL FLAT WASHER AND NUT FROM REAR OF MACHINE. REPEAT THIS PROCEDURE ON THE OTHER SIDE. THE TOP NET FITS IN BETWEEN THE TWO SIDE NETS AND SNAPS INTO THE FOUR CLIPS (TWO ON EACH SIDE) THAT ARE FASTENED TO THE INSIDE OF THE ORNAMENTAL SIDE NET CHANNELS.

12. PLACING THE BALLS IN THE ALLEY. IF A 9 BALL GAME IS DESIRED THEN A TOTAL OF 12 BALLS CAN BE INSTALLED IN THE ALLEY FOR FAST OPERATION BETWEEN GAMES. IF A 6 BALL GAME IS DESIRED THEN THERE CAN BE A TOTAL OF 9 BALLS INSTALLED IN THE ALLEY. OPEN COIN COVER ON RIGHT SIDE OF ALLEY, PLACE MECH INTO SLIDE. CONNECT JUNCTION PLUG KEEPING CABLE AWAY FROM REJECT AREA. CLOSE COVER AND LOCK. PLUG WIRE INTO PROPERLY WIRED 120v AC RECEPTICLE. USE A COIN TO OPERATE THE ALLEY AS IN NORMAL PLAY. THE NUMBER OF BALLS DESIRED WILL BE RELEASED. THE ALLEY IS READY FOR BUSINESS.

THIS MANUAL IS SUPPLIED WITH YOUR ORDER; REPLACEMENT OR ADDITIONAL MANUALS ARE \$12.10 EACH. A TROUBLESHOOTING MANUAL IS AVAILABLE FOR \$10.00

IF YOU PURCHASED YOUR CONTROLLER WITH A FIXED PROGRAM, THERE ARE TWO WAYS BY WHICH YOU CAN PROGRAM YOUR GAME SETTINGS. WE REFER TO THESE AS THE FIXED AND PROGRAMMABLE MODES.

I. FIXED MODE - SWITCH 4 IS ON

WHENEVER DIP SWITCH 4 IS TURNED ON, THE GAME WILL BE USING THE OPTIONS SELECTED BY YOU AT THE TIME OF PURCHASE. DURING THIS MODE YOU WILL BE ABLE TO CONTROL SOME OF THE OPTIONS BY USE OF THE 8 POSITION DIP SWITCH LOCATED AT U13. THE FOLLOWING CHART DESCRIBES THE PROCEDURE:

SWITCH	POSITION	FUNCTION
1	OFF	TICKET DISPENSER ON
1	ON	TICKET DISPENSER OFF
2	OFF	FREE GAME OFF
2	ON	FREE GAME ON
3	OFF	9 BALLS (FACTORY SET-DO NOT TOUCH)
3	ON	6 BALLS
4	OFF	PROGRAMMABLE
4	ON	FIXED PROGRAM
5	OFF	STANDARD ALLEY (FACTORY SET-DO NOT TOUCH)
5	ON	MINI ALLEY
6	OFF	RESERVED FOR DIAGNOSTICS IN THE FUTURE
6	ON	RESERVED
7	8	# OF COINS
OFF	OFF	1
OFF	ON	2
ON	OFF	3
ON	ON	4

NOTE!!! WHENEVER YOU CHANGE A DIP SWITCH SETTING YOU MUST TURN THE ALLEY OFF AND ON!!!

II. PROGRAMMABLE MODE - SWITCH 4 IS OFF

STEP 1 - APPLY POWER

AFTER THE GAME HAS BEEN PLUGGED IN, THE CONTROLLER WILL IMMEDIATELY PLAY THE "POWER-UP" TUNE AND TURN ON THE "GAME OVER" LIGHT. NEXT, IT WILL DELAY 5 SECONDS BEFORE DISPLAYING THE CONTROLLER REVISION CODE FOR 3 SECONDS. THE SCORE WILL CHANGE TO 990 FOR ABOUT 10 SECONDS; THIS SHOULD GIVE THE OPERATOR ENOUGH TIME TO POSITION HIMSELF IN FRONT OF THE MACHINE WHERE HE CAN BEGIN THE PROGRAMMING, USING THE KNOCK-OFF SWITCH LOCATED AT THE LOWER LEFT HAND SIDE OF THE ALLEY ON THE STAINLESS STEEL COVER. THE PROGRAMMING MODE CAN BE ENTERED DURING A 4 SECOND "WINDOW", WHICH OPENS AFTER THE SCORE CHANGES FROM 990 TO 000 AND CLOSES

WHEN THE DISPLAY GOES INTO THE ROTATING SEGMENT MODE. WHEN PROGRAMMING THE GAME WITH THE SWITCH, YOU WILL HAVE TO KEEP THE BUTTON DEPRESSED FOR ABOUT 2 SECONDS. THE CONTROLLER WILL LET YOU KNOW WHEN YOU HAVE HELD THE SWITCH CLOSED LONG ENOUGH BY BLINKING THE SCORE ON AND OFF AND BEEPING ONCE. IT WILL CONTINUE TO BLINK UNTIL YOU RELEASE THE BUTTON. YOU CAN PROCEED TO THE NEXT STEP. NOTE!!! KEEP THE BUTTON DEPRESSED UNTIL THE DISPLAY BEGINS TO BLINK ON AND OFF, THEN RELEASE THE BUTTON!!!

## STEP 2 - MENU MODE

WHEN ENTERING THE MENU MODE, EITHER OF 2 THINGS MAY HAPPEN:

1. THE SCORE WILL DISPLAY 000 AND THE BALL COUNT WILL BE 0, INDICATING THE MACHINE HAS BEEN PREVIOUSLY PROGRAMMED AND RE-PROGRAMMING IS OPTIONAL AT THIS TIME. IF YOU ELECT TO DO NOTHING, THE GAME WILL ENTER THE ATTRACT MODE IN 5 SECONDS AND THE STANDARD SCORES, WHICH WERE SET AT THE FACTORY, WILL BE USED. OR, YOU CAN DEPRESS THE KNOCK-OFF SWITCH AND ENTER THE PROGRAMMING MODE AS SHOWN IN STEP 3.
2. THE SCORE WILL DISPLAY 010, AND THE BALL COUNT WILL BE SET TO 1. THIS MEANS YOU WILL HAVE TO DO 1 OF 2 THINGS:
  - A. PROGRAM THE NEW PARAMETERS, OR
  - B. LET THE MACHINE PROGRAM ITSELF BY STEPPING THROUGH THE 7 PROGRAMMABLE OPTIONS AND LOADING IN THE DEFAULT SELECTIONS WITHOUT ANY INTERVENTION FROM THE OPERATOR. THIS WILL TAKE ABOUT 8 MINUTES TO COMPLETE, AFTER WHICH THE GAME WILL AUTOMATICALLY ENTER INTO THE ATTRACT MODE.

## STEP 3 - PROGRAM MODE

DURING THE PROGRAMMING SEQUENCE THE BALL COUNT DISPLAY IS USED TO IDENTIFY THE CURRENT SELECTION, AND THE SCORE DISPLAY IS USED TO IDENTIFY THE AVAILABLE OPTIONS. AS THE PROGRAM STEPS THROUGH THE VARIOUS SELECTIONS IT WILL PAUSE AT EACH OPTION FOR ABOUT 4 SECONDS. IT IS DURING THIS TIME THE OPERATOR CAN MAKE A SELECTION BY DEPRESSING THE KNOCK-OFF SWITCH. NOTE!!! IF NO OPTION IS SELECTED DURING THIS PROCESS THE DEFAULT VALUE WILL BE USED. THE DEFAULT VALUES ARE THE STANDARD SCORES STORED IN THE CONTROLLER'S EPROM.

PRESENTLY, THE FOLLOWING SELECTIONS ARE AVAILABLE:

1. WINNER SCORE  
-----

THIS VALUE DETERMINES WHEN THE "WINNER SONG" IS PLAYED AND WHEN THE FIRST TICKET IS ISSUED (IF THE TICKET DISPENSER IS ON). THE RANGE FOR THIS SELECTION IS FROM 010 TO 950. IT WILL BEGIN WITH 010 AND GO TO 300 IN INCREMENTS OF 10. IT WILL THEN GO FROM 300 TO 950 IN INCREMENTS OF 50. THE DEFAULT VALUE IS 150.

2. FREE GAME SCORE  
-----

THE RANGE FOR THIS SELECTION IS 000 TO 950. IT INCREASES THE SAME AS THE WINNER SCORE, EXCEPT IT BEGINS AT 000. IF IT IS DESIRED THAT NO FREE GAMES ARE TO BE ISSUED, DEPRESS THE KNOCK-OFF SWITCH WHILE 000 IS BEING DISPLAYED. THE DEFAULT VALUE IS 000, NO FREE GAME.

3. TICKET SPAN POINTS  
-----

THE RANGE FOR THIS SELECTION IS 010 TO 090 IN INCREMENTS OF 10. THIS VALUE DETERMINES THE INTERVALS AT WHICH THE TICKETS WILL BE ISSUED. FOR EXAMPLE, IF THE WINNER SCORE IS SET TO 150 AND THE TICKET SPAN IS SET TO 30, THE FIRST TICKET IS ISSUED AT 150, THE NEXT ONE WOULD BE ISSUED AT 180, THEN 210, AND EVERY 30 POINTS THEREAFTER. THE DEFAULT VALUE IS 30.

4. NUMBER OF TICKETS  
-----

THE RANGE FOR THIS SELECTION IS 00 TO 09 IN INCREMENTS OF 1. THIS WILL DETERMINE THE AMOUNT OF TICKETS ISSUED AT THE WINNER SCORE AND SPAN POINTS. IF YOU WISH TO TURN THE TICKET DISPENSER OFF, SELECT OPTION 00. THE DEFAULT VALUE IS 00, NO TICKETS.

5. IDLE SONG  
-----

THERE ARE ONLY 2 OPTIONS AVAILABLE FOR THIS SELECTION. THEY ARE 00 TO TURN THE SONG OFF, AND 01 TO TURN THE SONG ON. THE DEFAULT VALUE IS 00, NO IDLE SONG.

6. NUMBER OF COINS  
-----

THE RANGE FOR THIS SELECTION IS 00 TO 09 IN INCREMENTS OF 1. IF 00 IS SELECTED NO MONEY IS REQUIRED AND THE BALLS WILL AUTOMATICALLY BE DISPENSED. THE DEFAULT VALUE IS 01, 1 COIN.

7. HIGH SCORE SONG  
-----

THE RANGE FOR THIS SELECTION IS 010 TO 950. IT WILL GO FROM 010 TO 100 IN INCREMENTS OF 10. IT WILL THEN GO FROM 100 TO 950 IN INCREMENTS OF 50. THIS VALUE DETERMINES WHEN THE "HIGH SCORE" SONG IS PLAYED. THE DEFAULT VALUE IS 250.



## FUNCTIONAL DESCRIPTION

AFTER THE PROPER NUMBER OF COINS IS INSERTED THE MICROPROCESSOR TURNS THE BALL RELEASE SOLENOID ON, UNTIL THE PROPER NUMBER OF BALLS IS RELEASED. THE FOLLOWING CONDITIONS SHOULD EXIST:

- A. SCORE IS 000
- B. BALL PLAYED IS 0
- C. WINNER, FREE GAME, AND GAME OVER LIGHTS ARE OFF
- D. TUNE WILL PLAY AFTER COIN IS INSERTED

THE ALLEY IS NOW READY TO BE PLAYED. IF A BALL IS ROLLED AND GOES INTO THE FIFTY POCKET, THE SCORE WILL INCREASE BY 10 EVERY TIME IT PASSES ONE OF THE SCORE SWITCHES. THEREFORE, AFTER THE BALL REACHES THE BOTTOM OF THE SCORE TRACK, THE SCORE SHOULD HAVE INCREASED BY 50. ALSO SHORTLY AFTER PASSING THE LAST SWITCH IN THE TRACK, A TUNE SHOULD BE PLAYED BY THE MICROPROCESSOR. EACH POCKET HAS ITS OWN INDIVIDUAL TONE. IF HOWEVER DURING THE SCORING TIME A WINNING SCORE IS ACHIEVED THE WINNER SONG IS PLAYED INSTEAD OF THE POCKET SOUND. THIS IS ALSO TRUE IF A FREE GAME OR HIGH SCORE IS ACHIEVED. EACH ACHIEVEMENT HAS ITS OWN SOUND.

AFTER THE BALL HAS BEEN ROLLED AND SCORE HAS INCREASED THE BALLS PLAYED SHOULD INCREASE BY ONE AS IT PASSES THE BALL COUNT SWITCH. IF THE BALL DOES NOT GO INTO ANY OF THE POCKETS (A GUTTER BALL), A GUTTER BALL TONE IS PLAYED AND THE BALLS PLAYED ARE INCREASED BY ONE. WHEN THE LAST BALL IS PLAYED, THE SCORE WILL FLASH FOR (APPROXIMATELY) 20 SECONDS. DURING THIS TIME THE PLAYER CAN START HIS FREE GAME, IF ACHIEVED, BY DEPRESSING THE RESET SWITCH. AFTER THE 20 SECONDS DELAY, THE MACHINE WILL GO INTO THE ATTRACT MODE, IF A FREE GAME WAS WON THEN IT WILL NOW BE DISPENSED AUTOMATICALLY. THE ONLY WAY TO STOP THE FLASHING AND/OR GET THE FREE GAME IS TO PRESS THE KNOCK OFF SWITCH.

THE LAST SCORE CAN BE RECALLED BY DEPRESSING THE KNOCKOFF SWITCH.

## TICKET DISPENSER

### 1. BASIC ELECTRONIC OPERATION OF TICKET DISPENSER MODEL DL1275H

WHEN THE CONTROL UNIT CALLS FOR A TICKET TO BE ISSUED, THE MOTOR IN THE DISPENSER IS TURNED ON. WHEN A TICKET IS DISPENSED, THE OPTO BEAM BREAKER SENSES A NOTCH IN THE TICKET AND SENDS BACK A SIGNAL TO THE CONTROL UNIT. AT THIS TIME THE TICKET COUNTER IS INCREMENTED. IF NO MORE TICKETS ARE CALLED FOR THE MOTOR IS TURNED OFF.

### 2. BASIC MECHANICAL OPERATION OF THE TICKET DISPENSER MODEL H

TICKETS ARE MOVED THROUGH THE TICKET CHUTE BY MEANS OF A POWER DRIVEN ROLLER WHICH IS SPRING LOADED AGAINST AN IDLER ROLLER. THE POWER DRIVEN ROLLER HAS TWO NEOPRENE O RINGS INSTALLED, AND UNDER NORMAL OPERATING CONDITIONS ARE THE ONLY CONTACT WITH THE TICKETS.

pa

THE POWER DRIVEN ROLLER IS MOUNTED ON THE OUTPUT SHAFT OF THE MOTOR GEAR TRAIN ASSEMBLY. THE MOTOR ASSEMBLY IS MOUNTED TO THE PIVOT BRACKET ASSEMBLY IN THE TWO OILITE BEARINGS. THE MOTOR ASSEMBLY HAS A LIMITED FREE SWING, LIMITED BY A SINGLE PIN ENGAGED IN THE BRAKE SPRAG. THE BRAKE SPRAG ENGAGES THE ROLLER AS AN ANTI THEFT DEVICE. WITH THE FREE SWING OF THE MOTOR ASSEMBLY, THE DIRECTION OF TORQUE, WHEN THE ELECTRIC POWER IS APPLIED, IS IN A DIRECTION SO AS TO RELEASE THE BRAKE SPRAG. WHEN AN ATTEMPT IS MADE TO PULL TICKETS FROM THE MACHINE WITH THE POWER OFF, THE TORQUE IS REVERSED AND THE BRAKE SPRAG IS ENGAGED. ALSO, THE PULLING OF TICKETS WILL CAUSE THE PIVOT BRACKET ASSEMBLY TO APPLY A PRESSURE TO THE POWER DRIVEN ROLLER AGAINST THE TICKET AND IDLER ROLLER GREATER THAN THE PRE-SET SPRING LOAD. THIS WILL CAUSE THE O RINGS TO DEPRESS AND THE COURSE KNURLED SURFACE OF THE ROLLER WILL THEN GRIP THE TICKETS. ONE OUNCE OF PULL WILL APPLY 20 LBS. OF PRESSURE ON THE ROLLERS.

### 3. LOADING OF TICKETS

TICKETS ARE ENTERED IN THE REAR OF TICKET CHUTE AND PUSHED FORWARD. THE POWER DRIVEN ROLLER WILL BE SPRING LOADED AGAINST THE IDLER ROLLER AND TICKETS WILL NOT PASS UNTIL THE ROLLERS ARE CLEAR OF EACH OTHER. THIS IS ACCOMPLISHED BY USE OF THUMB AND INDEX FINGER, ONE PLACED ON THE BLOCK TO WHICH THE SPRING IS ATTACHED, THE OTHER ON THE PIVOT BRACKET ASSEMBLY, THEN SQUEEZE. PUSH THE TICKETS THROUGH UNTIL YOU SEE THE EDGE OF THE TICKET. MACHINE IS NOW READY TO OPERATE.

### 4. TICKET DISPENSER CONTROLLER BOARD

ATTACHED TO THE TICKET MACHINE IS A TRANSISTOR MOTOR CONTROLLER WHICH PROVIDES DYNAMIC BRAKING TO ENSURE ACCURATE AND REPEATABLE TICKET STOPPING AFTER ISSUING ANY NUMBER OF TICKETS. INCLUDED AS PART OF THE CONTROLLER IS TICKET SENSING BY MEANS OF AN OPTO BEAM BREAKER SENSOR. ALSO INCLUDED IN SIGNAL CONDITIONING WHICH PROVIDES HIGH ELECTRICAL NOISE IMMUNITY. THE OUTPUT OF THE TICKET SENSING CIRCUITRY IS THE EQUIVALENT TO A SINGLE POLE DOUBLE THROW SWITCH.

### 5. ROLLER TENSION SPRING

THE ROLLER TENSION SPRING KEEPS CONSTANT TENSION ON THE TICKETS, WHICH INSURES PROPER DELIVERY AND PREVENTS TICKETS FROM BEING PULLED THROUGH WHEN THE DISPENSER IS IDLE. TO INCREASE TENSION, LOOSEN SCREW AND MOVE SPRING FORWARD. TENSION IS ADJUSTED CORRECTLY WHEN THE TICKETS CANNOT BE PULLED FROM THE DISPENSER.

### 6. TICKET GUIDE SPRING

THE TICKET GUIDE SPRING INSURES THAT THE NOTCHES IN THE TICKETS PASS THROUGH THE OPTO BEAM BREAKER SENSOR. TO INCREASE TENSION, LOOSEN SCREW AND MOVE OUTER SPRING UP. THIS CHANGES THE TENSION ON THE INNER SPRING. TICKETS SHOULD BE SNUG BETWEEN SPRING AND SIDE PLATE BUT NOT DEFORMED BY EXCESS TENSION. THIS SPRING IS

ADJUSTED AT THE FACTORY FOR 1-3/16" WIDE TICKETS.

#### 7. TICKET STOP ADJUSTMENT

THE TICKET STOP ADJUSTMENT ALLOWS POSITIONING OF TICKETS WHILE MACHINE IS OFF. THE TICKET SHOULD PROTRUDE THROUGH SLOT APPROXIMATELY 1/16". THE TICKET DISPENSER PC BOARD IS MOUNTED WITH TWO SCREWS AND TWO SLOTTED HOLES. LOOSENING THE SCREWS AND MOVING THE BOARD FORWARD WILL ALLOW THE TICKETS TO STOP FARTHER OUT BEYOND THE EDGE OF THE SLOT.

CONDITIONS WHICH COULD CAUSE "HELP" OR "CALL"

1. DISPENSER OUT OF TICKETS
2. INSUFFICIENT TENSION ON ROLLER TENSION SPRING
3. TICKETS STOPPING BACK TOO FAR IN SLOT CAUSING TICKETS TO JAM
4. TICKET GUIDE SPRING NOT GUIDING TICKETS
5. DIRT ON OPTO BEAM BREAKER
6. MISSING NOTCHES ON TICKETS
7. DEFECTIVE DISPENSER CONTROLLER BOARD OR MOTOR

TICKETS ARE AVAILABLE THROUGH: NATIONAL TICKET CO IN SHAMOKIN, PA (717) 648-6803. WE HAVE FOUND THESE TICKETS TO BE OF THE BEST QUALITY FOR USE IN SKEE BALL MACHINES.

GENERAL TROUBLESHOOTING OF SKEE-BALL ALLEY'S

PROBLEM	RECOMMENDATION
NO DISPLAY	1.MAKE SURE POWER IS APPLIED TO THE ALLEY   2.FAN SHOULD BE ON, IF NOT REPLACE FUSE ON   SIDE OF CONTROLLER.   3.REPLACE DISPLAY WITH A KNOWN GOOD DISPLAY   4.CHECK F1 ON CONTROLLER BD.   5.REPLACE CONTROLLER
DISPLAY MISSING SEGMENTS	1.REPLACE BULBS   2.INSPECT SOCKETS   3.REPLACE DISPLAY
DOUBLE SCORING DOUBLE BALL COUNT	1.ADJUST SWITCHWIRE AWAY FROM BALL   2.REPLACE SWITCH
MISSING SCORES MISSING BALL COUNT	1.ADJUST SWITCHWIRE TOWARDS THE BALL   2.REPLACE THE SWITCH
COINS-UP BUT DOES NOT RELEASE BALLS	1.CHECK F2 ON CONTROLLER (1/2 AMP SLO-BLO)   2.INSPECT SPRINGS & CONTROLL RODS   3.REPLACE SOLENOID   4.REPLACE CONTROLLER
WILL NOT COIN-UP	1.INSPECT COIN MECH. SWITCH   2.MAKE SURE UNIT IS PROGRAMMED PROPERLY   3.REPLACE CONTROLLER
DOES NOT GIVE TICKET AT WINNING SCORE DISPLAYS "HELP" OR "CALL"	1.OUT OF TICKETS, READ MANUAL FOR INSTRUCTIONS   2.TICKETS JAMMED, READ MANUAL FOR INSTRUCTIONS   3.CLEAN OPTIC EYE, READ MANUAL FOR INSTRUCTIONS   4.REPLACE TICKET DISPENSER   5.REPLACE CONTROLLER
DOES NOT GIVE TICKET DOES NOT DISPLAY "HELP" OR "CALL"	1.READ SECTION OF MANUAL DEALING WITH   PROGRAMMING THE CONTROLLER   2.CHECK SETTINGS ON DIP SWITCH
GIVES MORE THAN 1 TICKET	1.ADJUST TENSION SPRING   2.REPLACE O-RING ON DRIVE ROLLER   3.REPLACE BRAKE SPRAG   4.REPLACE DRIVE ROLLER
NONE OF THE ABOVE	1.READ MANUAL   2.BEFORE CALLING SKEE-BALL MAKE SURE YOU KNOW   YOUR MODEL # AND SERIAL # FROM THE CONTROLLER

## TROUBLE SHOOTING GUIDE

CAUTION: HIGH VOLTAGE IS PRESENT IN SOME AREAS OF THE ALLEY (POWER SUPPLY, FAN SOLENOID, ETC.) UNPLUG LINE CORD BEFORE PERFORMING ANY TROUBLE SHOOTING.

### A. IMPROPER SCORING

EACH OF THE FIVE SWITCHES IN THE SCORE TRACK SHOULD SCORE TEN POINTS. TO DETERMINE WHICH SWITCH IS NOT FUNCTIONING PROPERLY, SIMPLY ROLL A BALL INTO EACH POCKET STARTING WITH 10 AND INCREASING TO 50. THE FIRST SWITCH THAT SCORES IMPROPERLY IS SUSPECT. AN INTERMITTENT SWITCH CAN GIVE MISLEADING RESULTS. IN THAT CASE, ROLL AS MANY BALLS AS NEEDED IN EACH POCKET TO DETERMINE WHICH SWITCH MAY NEED ADJUSTING, OR THE ENTIRE SWITCH MAY NEED REPLACING.

### B. IMPROPER BALL COUNT DISPLAY

CHECK THE SWITCH IN RIGHT REAR SIDE OF THE RUNWAY IN THE NO SCORE FLOOR AREA FOR PROPER ACTION. THE ACTUATING ARM MAY NEED ADJUSTING OR THE ENTIRE SWITCH MAY NEED REPLACEMENT.

### C. NO SOUND

IF NO MUSIC OCCURS DURING THE PLAY OF A GAME, FIRST CHECK THAT THE VOLUME CONTROL (IN THE POWER SUPPLY) IS SET PROPERLY. THEN CHECK THAT THE CABLES ARE CONNECTED PROPERLY FROM THE POWER SUPPLY TO THE SPEAKER. NEXT MAKE SURE THAT THE SPEAKER IS NOT DAMAGED. REPLACE SPEAKER IF NECESSARY. THEN REPLACE THE POWER SUPPLY BOARD. IF THIS IS NOT THE PROBLEM, THEN RETURN THE UNIT AS PER INSTRUCTIONS.

### D. COIN INSERTION DOES NOT RESET SCORE

AFTER INSERTING COIN THE DISPLAY SHOULD GO TO 000. IF THIS DOES NOT OCCUR, CHECK THE COIN MECH SWITCH FOR PROPER ACTION. THE ACTUATING ARM MAY NEED ADJUSTING OR THE ENTIRE SWITCH MAY NEED REPLACING.

### E. COUNTERS DO NOT WORK

CHECK THE CABLE CONNECTION FROM THE COUNTERS TO THE LOGIC BOARD. REPLACE THE COUNTER WITH A GOOD COUNTER. IF IT STILL DOES NOT WORK, THEN REPLACE THE LOGIC BOARD. RETURN THE UNIT FOR REPAIR AS INSTRUCTED IN THIS TEXT.

### F. LAMP DOES NOT LIGHT

IF ANY LAMP DOES NOT LIGHT, FIRST CHECK TO INSURE THAT THE LAMP IS PROPERLY SEATED IN THE SOCKET. DO NOT REPLACE LAMPS WHILE POWER IS ON. USE ONLY THE PROPER REPLACEMENT BULBS. REMOVE BULB BY THE GLASS PORTION OF THE BULB ONLY. DO NOT PLACE ANY TOOL IN THE SOCKET WHILE THE POWER IS ON. THIS COULD DAMAGE EXPENSIVE CIRCUITRY.

IF THE LAMP STILL DOES NOT LIGHT, AND THE FAULTY LAMP IS A SCORE OR BALL COUNT DISPLAY LAMP, THEN REMOVE THE IC (ULN2003) BELOW THE DIGIT WITH THE FAULTY LAMP AND REPLACE IT WITH THE PROPER REPLACEMENT IC. NEXT TRY REPLACING THE IC UNDER THE ULN2003 (74C14). ALWAYS POWER DOWN TO REPLACE LAMPS AND IC'S. MAKE ABSOLUTELY SURE THAT THE NEW IC'S ARE INSTALLED PROPERLY. IDENTIFY THE DIRECTION OF WHICH THE NEW IC IS TO BE INSTALLED BEFORE THE SUSPECTED BAD IC IS REMOVED.

IF THE LAMP IS ONE OF THE FOUR LIGHTS ABOVE THE READOUTS (FREE GAME, WINNER, OR GAME OVER) INSURE THAT THE BULBS AND SOCKETS ARE GOOD. CHECK THE READOUT CABLE CONNECTIONS BACK TO THE POWER SUPPLY. IF THE LAMP DOES NOT LIGHT THEN REPLACE IT AS INSTRUCTED ABOVE. IF THE LAMP STILL DOES NOT LIGHT, THEN REPLACE THE LOGIC AND/OR THE POWER SUPPLY AND RETURN FOR REPAIR.

#### G. HELP OR CALL APPEARS IN THE DISPLAY

WHEN THE WORD HELP APPEARS FROM THE BALLS PLAYED AND SCORE DISPLAY, IT MEANS THAT THE CPU BOARD HAS TURNED ON THE TICKET DISPENSER BUT HAS NOT SEEN THE SIGNAL BACK FROM THE TICKET DISPENSER TO INDICATE THAT A TICKET HAS BEEN DISPENSED. THIS WILL OCCUR IF THERE ARE NO MORE TICKETS, IF THEY HAVE JAMMED, IF TWO OR MORE NOTCHES ARE MISSING ON THE TICKET, OR IF THE CIRCUIT BOARD ON THE DISPENSER IS FAULTY. FIRST DEPRESS THE RESET SWITCH TO ATTEMPT TO CLEAR THE PROBLEM. IF THAT FAILS, THEN EXAMINE THE TICKET DISPENSER. IF A TICKET PROBLEM DOES EXIST, THEN REPAIR AND DEPRESS THE KNOCK OFF SWITCH. THE DISPENSER SHOULD NOW DELIVER THE PROPER NUMBER OF TICKETS OWED. IF HELP STILL APPEARS, THEN REPLACE AND RETURN THE UNIT FOR REPAIR.

FOR ALLEYS WITH LOGIC SERIAL NUMBER ABOVE 1420:

1. PLACE TICKETS IN THE DISPENSER SO THAT THE NOTCH IS IN LINE WITH PHOTO DETECTOR.

## WARRANTY REPAIRS

THE WARRANTY ON THE ELECTRONIC UNITS IS FOR A PERIOD OF ONE YEAR, INCLUDING SHIPPING ONE WAY. THE WARRANTY WILL BE VOID IF THE UNIT IS NOT INSTALLED PROPERLY, OR IF IT HAS BEEN TAMPERED WITH. THE RECEPTICLES FOR 3 PRONG PLUGS MUST BE USED, AS THE ELECTRONIC UNITS CALL FOR A POLARIZED CIRCUIT. WHEN RETURNING A UNIT FOR REPAIR, UNDER WARRANTY OR NOT, YOU MUST FIRST CALL AND OBTAIN AN AUTHORIZATION NUMBER. THIS NUMBER MUST BE WRITTEN ON THE OUTSIDE OF THE BOX YOU RETURN YOUR UNIT IN. IF YOU FAIL TO DO THIS, YOUR UNIT WILL BE REFUSED AND SENT BACK TO YOU. AN EXCHANGE PROGRAM IS OFFERED FOR THE FIRST SIX MONTHS YOU HAVE YOUR ALLEY. THIS ALSO MUST BE AUTHORIZED, FOR WE WILL SEND YOU A NEW BOARD IN EXCHANGE FOR THE RETURN OF YOUR OLD BOARD. AFTER SIX MONTHS, YOU MUST SEND YOUR BOARD IN FOR REPAIR. BEFORE CALLING SKEE BALL (215-362-0300), FIRST TRY AND LOCATE THE FAULTY PART, BUT DO NOT ATTEMPT REPAIR. MAKE SURE THAT YOU INCLUDE A NOTE WITH YOUR UNIT DESCRIBING THE PROBLEM IN YOUR OWN WORDS, AND BE SURE TO INCLUDE YOUR NAME AND PHONE NUMBER WHERE YOU CAN BE REACHED.

**NOTE!**  
PART NUMBERS FOR MOST FREQUENTLY ORDERED PARTS ARE LISTED NEXT TO THEIR APPROPRIATE BOX

5" AUDIO SCOREBOARD  
221-00H

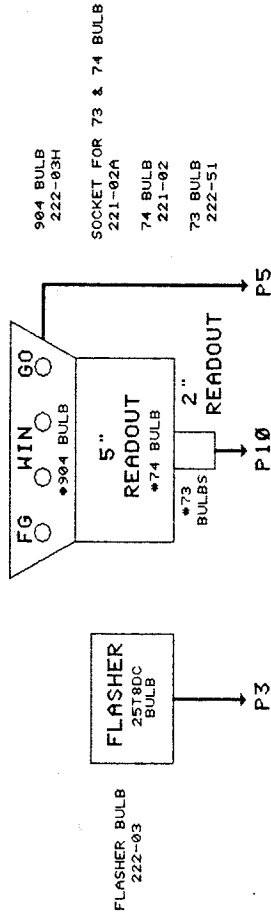

904 BULB  
222-03H

SOCKET FOR 73 & 74 BULB  
221-02A

74 BULB  
221-02

73 BULB  
222-51



FLASHER BULB  
222-03

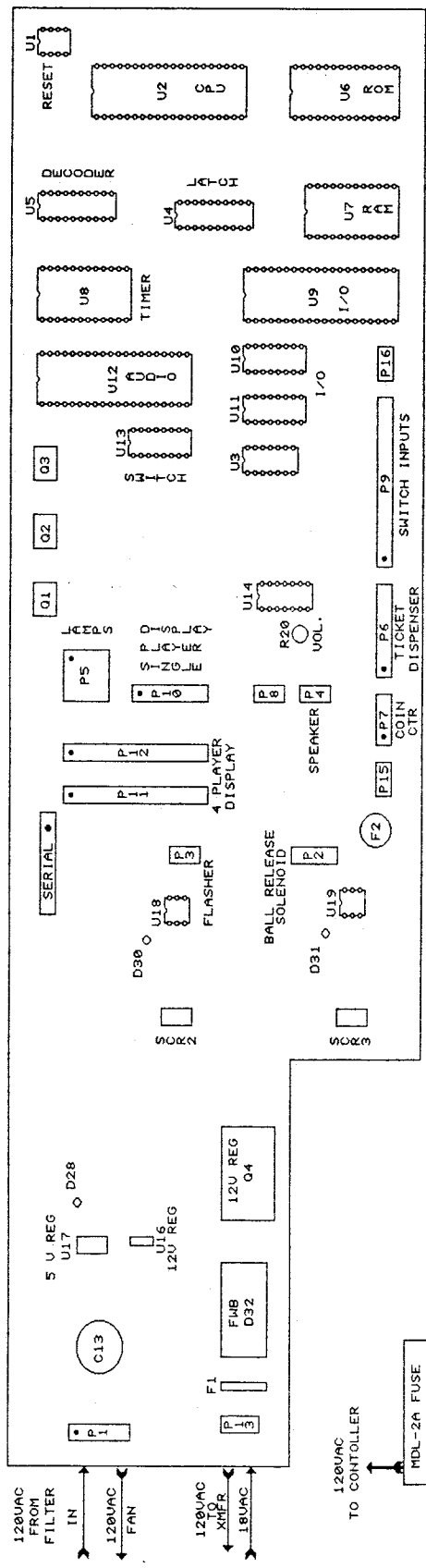

120VAC FROM FILTER IN

120VAC FAN

120VAC XFR

180VAC

120VAC TO CONTROLLER

MDL-2A FUSE  
EMI/RFI LINE  
FILTER

3 CONDUCTOR  
LINE CORD

**NOTE!**  
ALWAYS USE A PROPERLY  
GROUNDED 3 POSITION  
RECEPTACLE

MODEL S LOGIC BD.  
700-02

MODEL S CONTROLLER  
700-01

SKEE-BALL, INC.  
8TH & MAPLE STREETS  
LANSDALE, PA. 19446

SBC-1-A

D	REV-A	BLOCK DIAGRAM ALLEY
DATE:	4-24-89	SHEET 1 OF 1



1 2 3 4 5 6 7 8

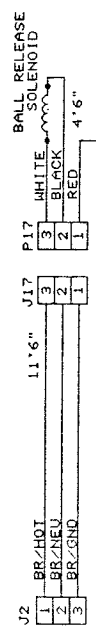
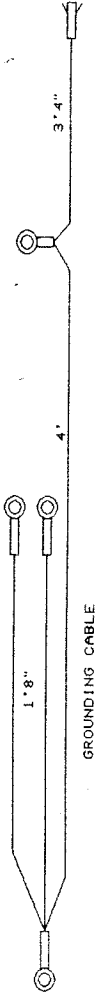
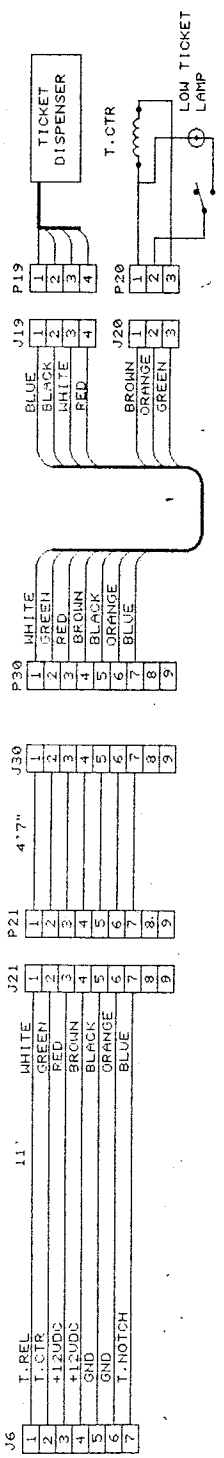
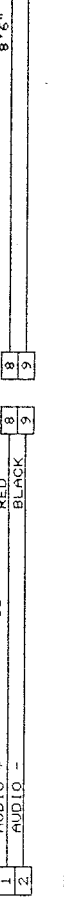
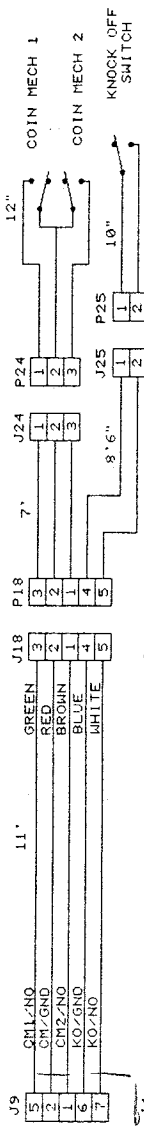
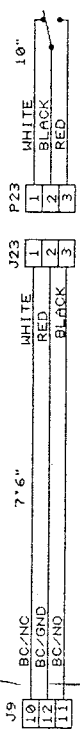
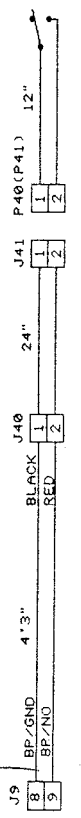
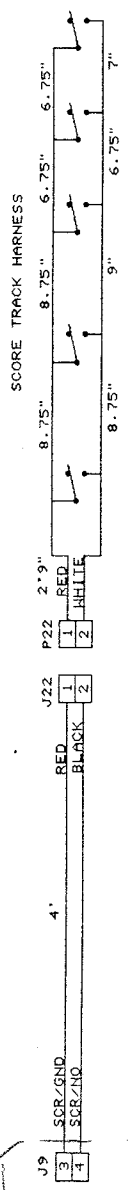

**SKEE-BALL, INC.**  
 8TH & MAPLE STREETS  
 LANSDALE, PA. 19446

CABLES 10 & 13 FOOT ALLEY WIRING HARNESS

D REV-A DATE: 02-09-88 SHEET 1 OF 1

1 2 3 4 5 6 7 8

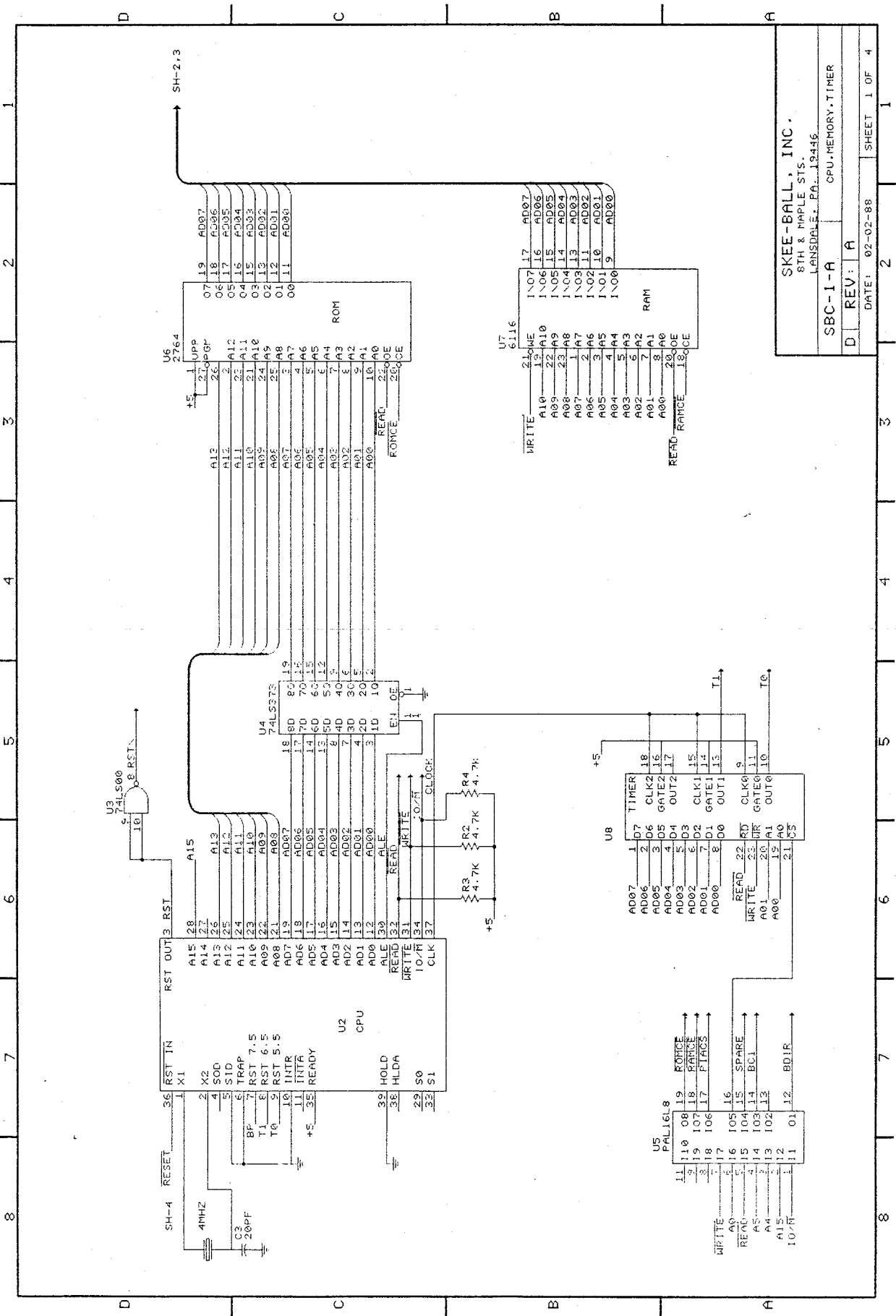

SKEE-BALL, INC.  
 8TH & MAPLE STS.  
 LANSDALE, PA. 19446

SBC-1-A CPU/MEMORY/TIMER  
 REV: A  
 DATE: 02-02-88  
 SHEET 1 OF 4

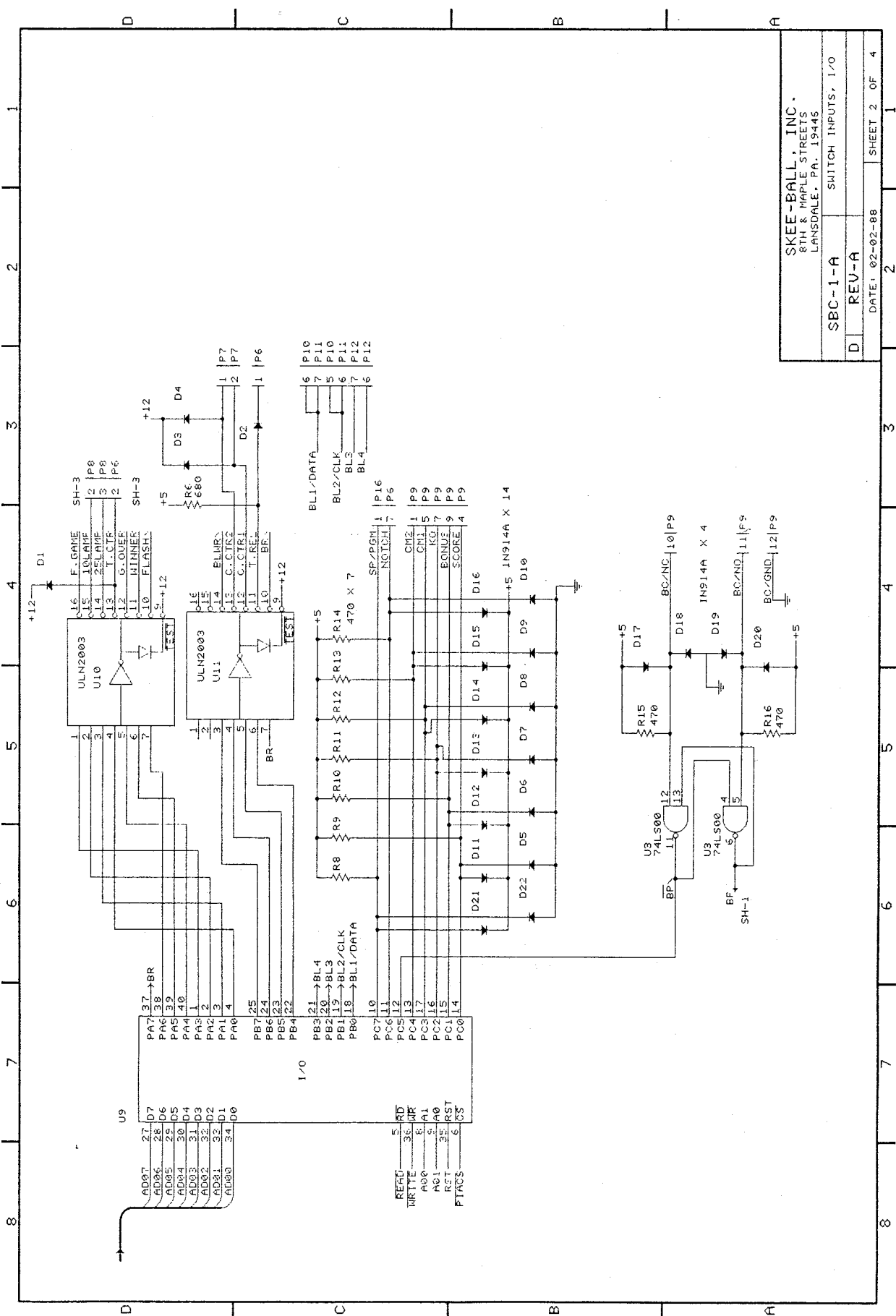

SKEE-BALL, INC.  
 8TH & MAPLE STREETS  
 LANSDALE, PA. 19446  
 SBC-1-A SWITCH INPUTS, I/O  
 D REV-A  
 DATE: 02-02-88  
 SHEET 2 OF 4

1 2 3 4 5 6 7 8

D C B A

1 2 3 4 5 6 7 8

D C B A

1 2 3 4 5 6 7 8

D C B A

1 2 3 4 5 6 7 8

D C B A

1 2 3 4 5 6 7 8

D C B A

1 2 3 4 5 6 7 8

D C B A

1 2 3 4 5 6 7 8

D C B A

1 2 3 4 5 6 7 8

D C B A

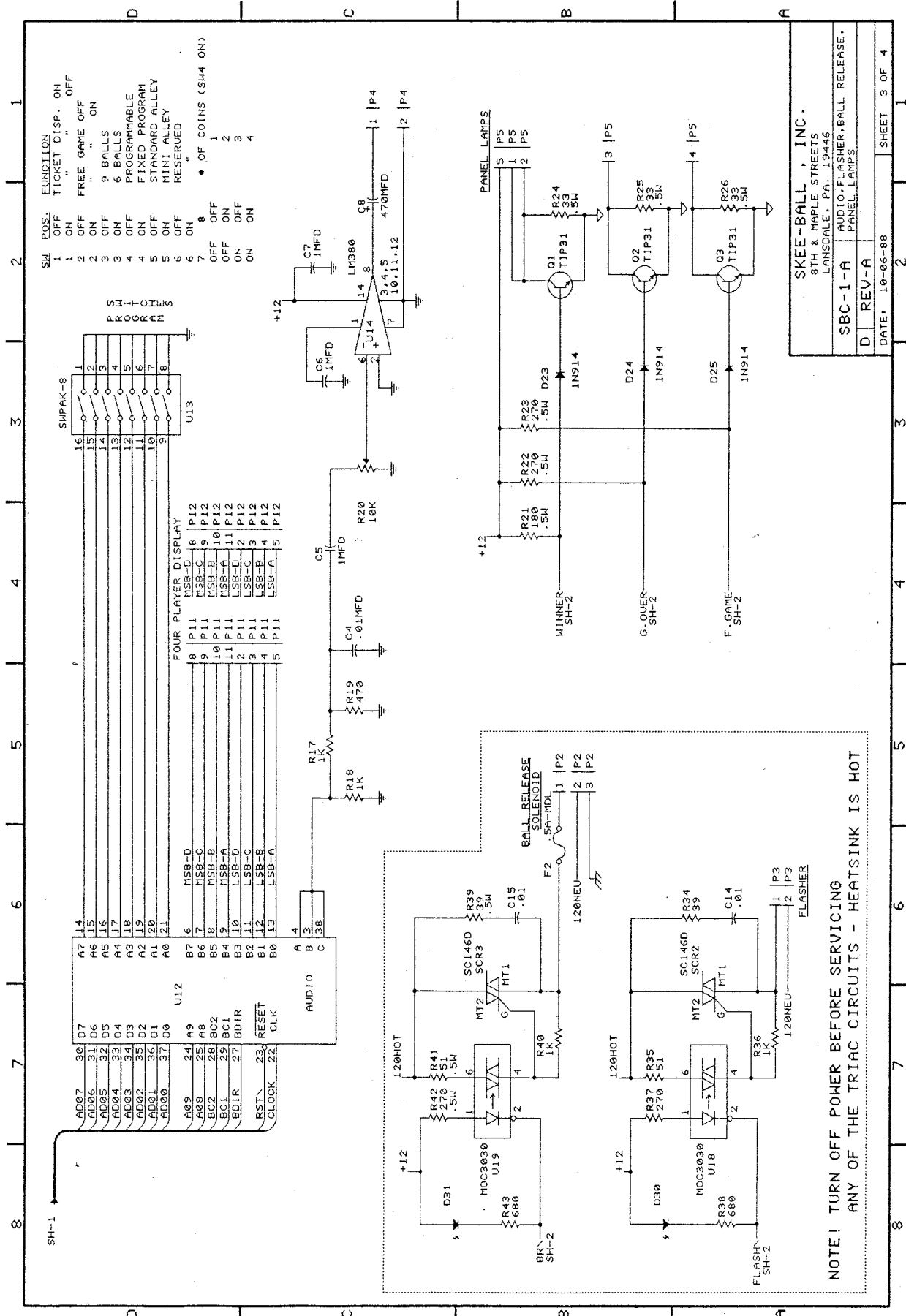

SW	POS.	FUNCTION
1	OFF	TICKET DISP. ON
1	ON	" " OFF
2	OFF	FREE GAME OFF
2	ON	" " ON
3	OFF	9 BALLS
3	ON	" " ON
4	OFF	PROGRAMMABLE
4	ON	" " ON
5	OFF	FIXED PROGRAM
5	ON	" " ON
6	OFF	STANDARD ALLEY
6	ON	" " ON
7	OFF	MINI ALLEY
7	ON	" " ON
8	OFF	RESERVED
8	ON	" " ON

SW	POS.	FUNCTION
1	OFF	TICKET DISP. ON
1	ON	" " OFF
2	OFF	FREE GAME OFF
2	ON	" " ON
3	OFF	9 BALLS
3	ON	" " ON
4	OFF	PROGRAMMABLE
4	ON	" " ON
5	OFF	FIXED PROGRAM
5	ON	" " ON
6	OFF	STANDARD ALLEY
6	ON	" " ON
7	OFF	MINI ALLEY
7	ON	" " ON
8	OFF	RESERVED
8	ON	" " ON

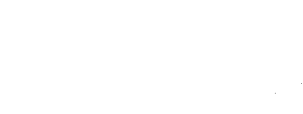
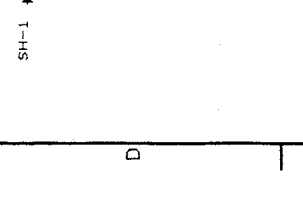
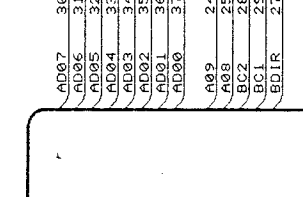
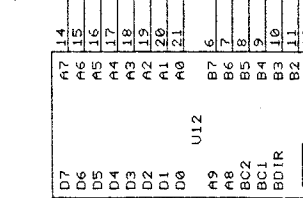
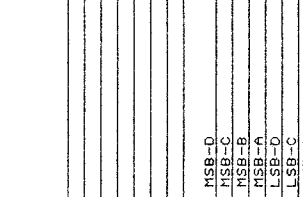
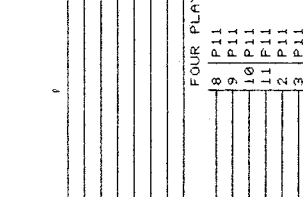
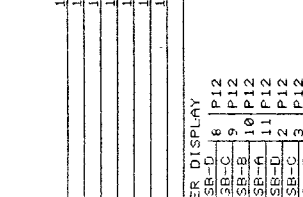
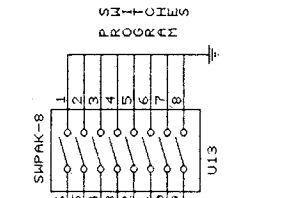

**SKEE-BALL, INC.**  
 8TH & MAPLE STREETS  
 LANSDALE, PA. 19446

**SBC-1-A** AUDIO-FLASHER, BALL RELEASE, PANEL LAMPS

**D REV-A**

DATE: 10-06-88

SHEET 3 OF 4

**NOTE! TURN OFF POWER BEFORE SERVICING ANY OF THE TRIAC CIRCUITS - HEATSINK IS HOT**

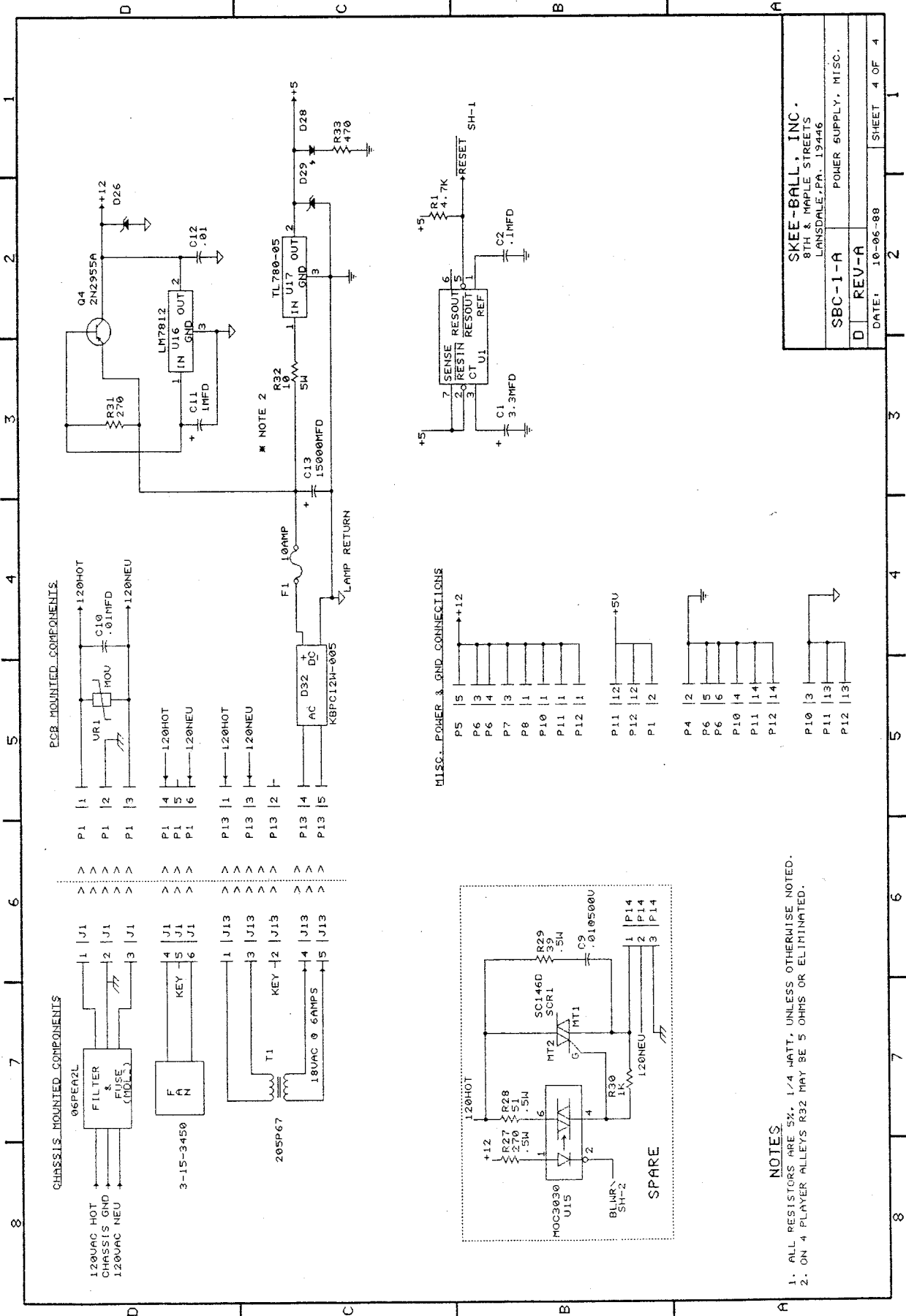

PCB MOUNTED COMPONENTS

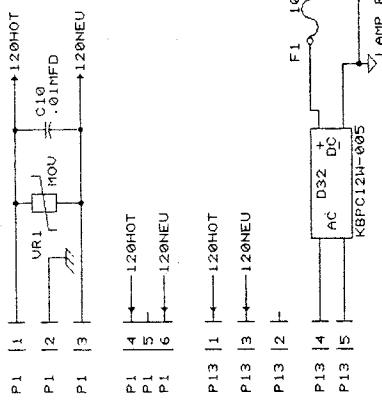

CHASSIS MOUNTED COMPONENTS

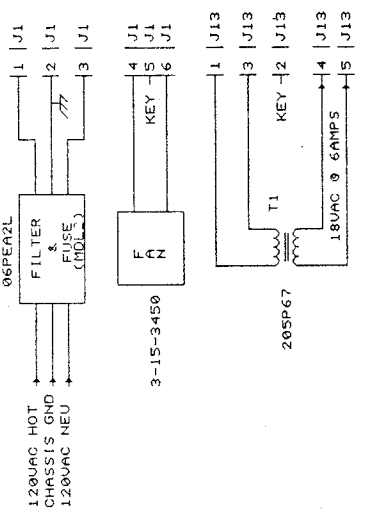

MISC. POWER & GND CONNECTIONS

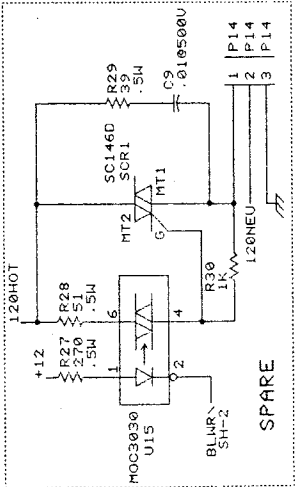
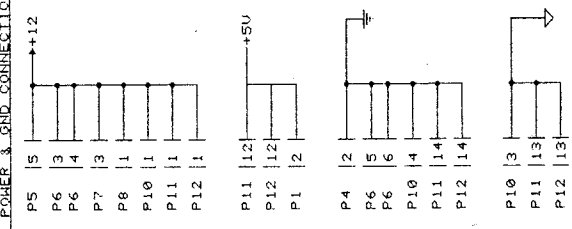

- NOTES
1. ALL RESISTORS ARE 5%, 1/4 WATT, UNLESS OTHERWISE NOTED.
  2. ON 4 PLAYER ALLEYS R32 MAY BE 5 OHMS OR ELIMINATED.

SKEE-BALL, INC.  
 8TH & MAPLE STREETS  
 LANSDALE, PA. 19446

SBC-1-A POWER SUPPLY, MISC.

D REV-A

DATE: 10-06-88

SHEET 4 OF 4

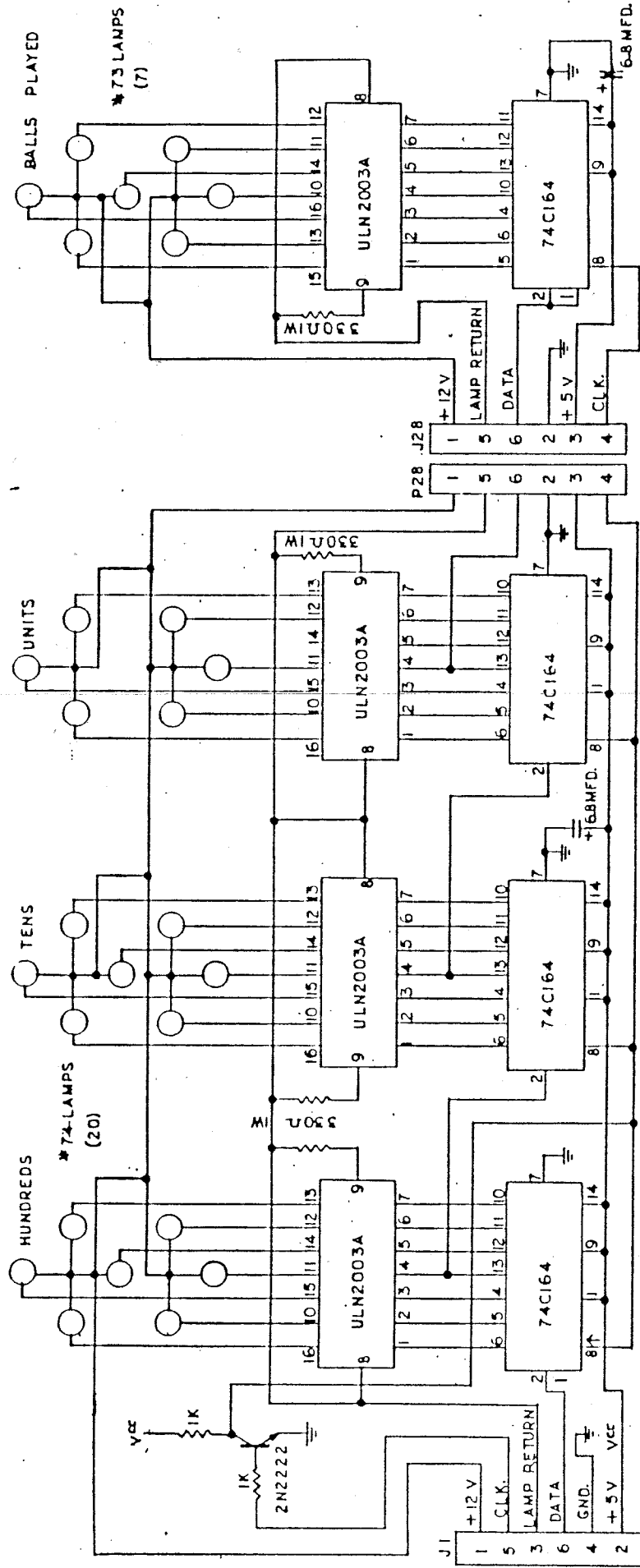

# BALL COUNT SWITCH

FIG # 1

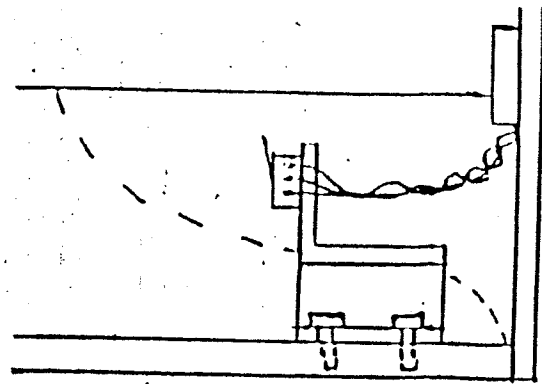

FIG # 2

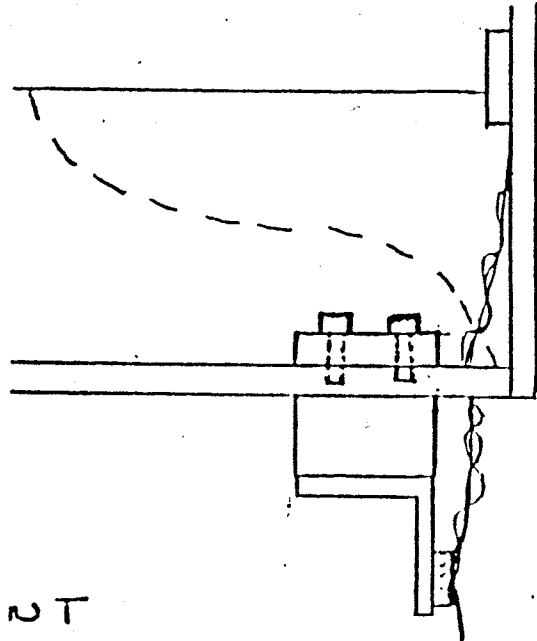

FIGURE # 1  
SHOWS HOW BALL COUNT  
SWITCH IS INSTALLED FOR  
SHIPPING ONLY.

FIGURE # 2

SHOWS HOW TO REPOSITION THE BALL  
COUNT SWITCH

SIMPLY TURN THE BALL COUNT BRACKET  
AROUND AND REINSTALL TO THE SAME  
PRE DRILLED HOLES IN THE BACK CABINET  
BULKHEAD.

FOR MORE INFORMATION SEE  
INSTALLATION INSTRUCTIONS PAGE 1

1/30/01

## SKEEBALL CLASSIC 13'

### Parts list

Item Number	Description	
800109- #	Key, include Number needed	\$ 2.30
800161-1	Sand Pad Set	\$ 8.50
800136-1	Number Set (Black)	\$ 4.73
800067-1	Solenoid, 4X240	\$ 28.50
991-01	Pint, Red Paint	\$ 11.26
<del>800179-1</del>	<del>Skee-Ball, Balls, Wood Natural Finish</del>	<del>\$ 4.48</del>
800065-1	Lock, 1612	\$ 7.26
800065-2	Lock, 2316 short or long	\$ 7.26
800065-4	Lock, BH-754	\$ 7.26
800773-3	Sensors, 415, (scoring)	\$ 11.26
<b>BACK CABINET</b>		
100047-1	Assy, Back Cabinet (complete)	\$ 1,200.00
100048-2	Assy, Back Cabinet, (painted wood only)	\$ 200.00
800181-1	Legs, Back Cabinet	\$ 20.00
800166-1	Back Brace, Black Plastic(hides cables)	\$ 14.25
800167-1	Knob, Black(panel)	\$ 2.14
100087-1	Display Panel, Classic	\$ 115.40
330-07	Bottom Trim, under display	\$ 4.38
900022-2	"T" Molding, Display set(yellow)	\$ 6.14
100039-1	Beacon Assembly	\$ 104.15
800076-2	Side Net Trim	\$ 40.95
800404-1	Net Assy, Lg, Right, Complete(with trim)	\$ 169.00
100159-1	Casting, Net, Upper Right	\$ 21.29
800280-2	Casting, Net, Lower Right	\$ 21.29
800404-2	Net Assy, Lg, Left, Complete(with trim)	\$ 169.00
100159-2	Casting, Net, Upper Left	\$ 21.29
800280-3	Casting, Net, Lower Left	\$ 21.29
800406-2	Side Net	\$ 89.00
800405-2	Top Net (net only)	\$ 69.00
800403-1	Top Net with Frame(complete)	\$ 160.00
800252-1	Top Net Center Trim	\$ 14.37
800285-2	Top Net Deflector Wire	\$ 4.75
200057-1	Carpet, Ball Return,	\$ 3.00
800199-1	"S" Net Clips	\$ 1.18
100068-1	Carpet Above Target Board	\$ 18.31
250-02	Target Board Carpet	\$ 54.33
100054-1	Target Board L Block (specify left or right)	\$ 1.80
800134-1	Ball Deflector	\$ 2.37
100076-1	Obstacle Rod Assembly	\$ 6.55



1/30/01

## SKEEBALL CLASSIC 13'

### Parts list

Item Number	Description	
100001-1	Pocket Angle Clips	\$ 0.62
100026-1	10 Point Pocket	\$ 59.59
100026-2	20 Point Pocket	\$ 36.03
100026-3	30 Point Pocket	\$ 25.39
100026-4	40 Point Pocket	\$ 23.80
100026-5	50 Point Pocket	\$ 19.01
100026-11	100 Point Pocket	\$ 19.01
800136-1	Decal, Number Set, 10 - 100(black)	\$ 4.72
800085-1	Bonus Trough	\$ 52.29
800129-1	Ball Drop Trough/cut	\$ 136.50
100083-1	No Score Floor	\$ 61.23
100073-1	Target Board Lighting Assy.	\$ 36.35
<b>RUNWAY</b>		
100090-13	Assy, 13' Alley, Complete	\$ 1,200.00
100091-3	13' Alley, Painted, wood only	\$ 300.00
100108-1	Assy, Ball Hop(requires carpet replacement)	\$ 69.39
100114-1	Assy, Locking Bracket	\$ 9.77
800729-16	Assy, Ball Return Track 13'	
100134-2	Right Rear Channel Cover	\$ 28.17
100134-1	Left Rear Channel Cover	\$ 28.17
100134-3	Left Middle Channel Cover	\$ 51.02
100134-4	Right Channel Cover with Ball View	\$ 100.18
900033-1	Mylar Trim per foot, (15' per game)	\$ 1.19
100045-1	Ticket Dispenser Cover, Complete Assembly	\$ 67.83
800194-1	Ticket Dispenser Hood Only	\$ 19.76
800222-1	Kickplate	\$ 55.44
800233-1	Front Carpet Clamp	\$ 22.44
800229-2	Rear Carpet Clamp	\$ 11.05
100004-2	Right Front Plinth, Painted	\$ 5.85
100004-4	Left Front Plinth, Painted	\$ 5.85
100133-1	Runway Banking Strip, Right(rubber)	\$ 8.74
100133-2	Runway Banking Strip, Left(rubber)	\$ 8.74
100132-1	Banking Strip Right, Painted	\$ 8.74
100132-3	Banking Strip Left, Painted	\$ 8.74
800212-1	Assy, Prog/Aux	\$ 7.50
100011-2	Carpet "S" Right	\$ 1.87
100011-1	Carpet "S" Left	\$ 1.87
100007-3	Door, Left Side, w/o Knock off hole	\$ 86.05
600072-1	Door, Card Swipe, D&B	\$ 40.00

## SKEEBALL CLASSIC 13'

1/30/01

## Parts list

Item Number	Description	
<b>ELECTRONICS/LIGHT</b>		
801143-1	Assy, Mod S-Controller(Classic)	\$ 540.00
800208-1	PCBA, SBD-4, Display board(LED)	\$ 227.00
800017-1	Controller, Fan	\$ 34.25
800090-2	Small LED	\$ 11.77
800090-1	Large LED	\$ 28.60
800208-1	LED Display Board	\$ 227.03
221-02A	Small Sockets	\$ 1.63
221-02A	Large Sockets	\$ 1.63
800203-1	Target Board Light Socket	\$ 6.00
800205-1	Target Lamps	\$ 7.43
800159-3	Flasher Lamps	\$ 5.13
800202-2	Cable, SBC Ticket Disp, Back Cabinet	\$ 21.00
800202-11	Cable, SBC Ticket Disp, Runway	\$ 17.00
800202-3	Cable, Solenoid, Back Cabinet	\$ 12.70
800202-10	Cable, Solenoid, Runway	\$ 6.00
800202-4	Cable, SBC Main Harness, Back Cab	\$ 63.00
800202-9	Cable, SBC Main Harness, Runway	\$ 34.00
800202-5	Cable, SBC Display Data, 8 pin(7 conductor)	\$ 15.00
800883-19	Cable, Score Track, (sensors)	\$ 8.00
800972-1	Cable, Direct Payout, Alley to Alley	\$ 17.00
800950-2	Cable, Direct Payout, SBI-2 to Controler	\$ 12.00
800883-24	Cable, Ball Release/Count Runway	\$ 14.00
800971-1	Cable, Ball Release/Count Back Cabinet	\$ 12.00
<b>COMPLETE KIT</b>		
100024-4	Target Board Complete -- W/ Bonus Pocket	\$ <del>541.00</del> 459.00
100024-5	Target Board Complete, No Bonus Pocket	\$ <del>284.09</del> 341.34
800003-1	Carpet Kit, Orange Cork	\$ 119.91
100174-1	LED Display Kit	\$ 309.55