

Instruction Manual for

CAPE COD



Williams® ELECTRONICS, INC.
SUBSIDIARY OF THE SEEBURG CORPORATION

3401 N. California Ave.
Phone 267-2240

Chicago, Ill. 60618, U.S.A.
Cable Address: Wilcoin

GENERAL INSTRUCTIONS FOR SHUFFLE ALLEY

1. **INSTALLATION:** See Installation Instructions. After game is assembled, plug in connection jacks tightly. Plug line cord into A.C. ONLY, 60 cycles, 115 volts. The power to this game is controlled by a toggle switch which is located under the front part of the cabinet.
2. In low voltage areas (105 Volts or less) an additional boost in the output voltage of the transformer can be obtained by switching Rotary Adjustment Jack to "LOW".
3. To prevent abuse and cheating of this game, a vibration switch is installed on the back-door. Instructions for sensitivity are located adjacent to the switch.
4. To make the playfield rollover switches accessible for servicing, remove two screws from the access panel located directly below the switches and pull panel forward.
5. To change lite bulbs in hood insert or to work on pin panel assembly; open back door and remove (2) screws (shipping screws) from top rear of pin panel. Now remove screw from each side of bottom member of hood frame and slide pin panel forward.
To remove pin panel completely, disconnect pin panel jacks.
6. Two rows of relays at bottom of back door are mounted to a hinged board. For easy service and adjustment, loosen wing nuts holding brackets at each side of board, pick board up 90 degrees and secure with stay arm.
7. All (6) Strike-Spare Units are mounted on a panel in bottom section of back-box. Entire panel can be taken out by removing (4) bolts.
8. To remove back glass, pull back on lock brackets at inside top of back box. From front of game, lift glass up and out.
9. The equipment panel (insert) is hinged for better servicing.
10. This game has multiple methods of play. Press the button on the front of the cabinet, at the start of the game, to select the type of scoring desired.
 - A. **REGULATION:** Scoring is identical to official bowling.
 - B. **STRIKE-SPARE BONUS:** This game scores the same as regulation, plus a bonus of 200 for a STRIKE or 100 for a SPARE if FLASHING LITES stop on red.
 - C. **FLASH SCORING:** Strike and spare scores are indicated by flashing lites. Lites stop flashing when the pins are hit on first shot.
 - D. **ROTO:** Scores 90 for a strike, 60 for a spare. If a strike is made, same player shoots to stop flashing lites. Strikes and spares score as indicated.
 - E. **STRIKES 90:** This game scores 90 for a strike, 60 for a spare. Player continues to shoot as long as he makes a strike. A spare, or blow, will advance to next players turn, or to next frame.
11. For a faster playing game, the spare shot can be thrown immediately after the first shot. NO waiting for the score.

WARRANTY

THE MOTORS IN ALL NEW WILLIAMS PRODUCTS
ARE UN-CONDITIONALLY GUARANTEED FOR
6 MONTHS FROM DATE OF PURCHASE.

ANY DEFECTIVE MOTORS RETURNED DURING THE
WARRANTY PERIOD WILL BE REPLACED FREE OF
CHARGE BY YOUR WILLIAMS DISTRIBUTOR.

IMPORTANT NOTICE

WHEN ORDERING PARTS ALWAYS SPECIFY NAME OF
UNIT, GAME AND SERIAL NUMBER, IN ADDITION TO A
CLEAR DESCRIPTION OF THE PART AND PART
NUMBER IF POSSIBLE.

UNIT PARTS LIST

UNIT NAME	CONTACT DISC	WIPER ASSEMBLY	RATCHET GEAR ASSEMBLY	MOTORS
STRIKE SPARE	C-6414-2	A-6443-3	A-6402-5	SCORE (60C)
FRAME CONTROL	C-6417	B-7456-5	A-6402A-11	14A-7765
PLAYER UP	C-6417-26	C-6521-4	A-6404-5	SCORE (50C)
GAME SELEC-				14A-7776
TION	C-6415	C-6521	A-6403	PIN RESET (60C)
EXTRA SHOTS	C-6414	A-6443-4	A-6402A-5	14A-7869
COIN	C-6412	A-6443-5	A-6402-5	PIN RESET (50C)
1-9	-----	-----	3C-7272	14A-7870
TENS	-----	-----	3C-7272	FLASH (60C)
HUNDREDS	-----	-----	3C-7272	14A-7766
THOUSANDS	-----	-----	3C-7272	FLASH (50C)
ROTO	-----	-----	3C-7272	14A-7775
SCORE MOTOR	C-6418-9	C-6519-7	-----	
FLASH MOTOR	C-6413-9	B-7456-4	B-6833	
CREDIT	-----	-----	A-6400-1	

COIL NUMBER	DESCRIPTION	LOCATION
<u>MOTORS & TRANSFORMERS</u>		
14 A-7765	SCORE MOTOR	BACK DOOR
14 A-7766	FLASH MOTOR	BACK DOOR
14 A-7869	PIN RESET MOTOR	PIN PANEL
15 A-6775	TRANSFORMER	BACK DOOR
24 A-6597-7	FLUORESCENT LAMP	INSERT
24 A-6597-5	FLUORESCENT LAMP ... (2 req'd.)	PIN PANEL
1 B-4276	CASH BOX COVER	COIN BOX
E 6872 SA	COIN BOX (with door only)	CENTER FRONT
C 6876	CASH BOX	COIN BOX
<u>SOLENOID COILS</u>		
A 24-975	PLAYER UP UNIT STEP UP FRAME CONTROL UNIT STEP UP	BACK DOOR BACK DOOR
A 25-1000	EXTRA SHOTS UNIT STEP UP COIN UNIT STEP UP STRIKE SPARE UNIT STEP UP ... (6 req'd.)	INSERT INSERT MECH. PANEL
B 27-1100	FRAME CONTROL RESET STRIKE SPARE UNIT RESET ... (6 req'd.) EXTRA SHOTS UNIT RESET PLAYER UP UNIT RESET COIN UNIT RESET	BACK DOOR MECH. PANEL INSERT BACK DOOR INSERT
B 28-1450	PIN RELEASE COIL ... (10 req'd.) ROTO UNIT STEP UP	PIN PANEL BACK DOOR
B1-29-1600	FRAME DRUM UNIT SCORE DRUM UNIT ... (24 req'd.)	INSERT INSERT
C2-27-1300	CHIME COIL	CABINET
D1-24-1400	RELAY BANK RESET COIL	BACK DOOR
FL 26P-950/ 250	GAME SELECTION UNIT STEP UP	BACK DOOR
<u>RELAY COILS</u>		
M 31 P-1500	1 -- 9 SCORE RELAY 10 --90 SCORE RELAY 100'S SCORE RELAY STRIKE SPARE ADVANCE RELAY ROTO RELAY GAME OVER RELAY STRIKE SPARE RESET RELAY ROTO ADVANCE RELAY	BACK DOOR BACK DOOR BACK DOOR BACK DOOR BACK DOOR BACK DOOR BACK DOOR BACK DOOR BACK DOOR
MX-33-2400	COIN LOCKOUT COIL	FRONT DOOR .
S 27-750	RELAY BANK COIL (#1 RELAY)	RELAY BANK
S 29-950	RELAY BANK COILS ... (15 req'd.)	RELAY BANK
XM 29-1100	COIN METER	CABINET
Z 29 P-1400	COIN RELAY SCORE RESET RELAY ... (3 req'd.)	BACK DOOR INSERT
Z 30-P-1800	ROLLOVER MOTOR RELAY PLAYER RESET RELAY EXTRA SHOTS RESET RELAY SCORE CONTROL RELAY SCORE MOTOR RELAY 3RD POSITION RELAY	BACK DOOR BACK DOOR BACK DOOR BACK DOOR BACK DOOR BACK DOOR
Z 30-1600	FLASH MOTOR RELEASE COIL	BACK DOOR
Z 31-P-2000	REAR ROLLOVER RELAY PIN RESET RELAY REPEAT STRIKE RELAY FLASH RELAY STRIKE RELAY GAME OVER RELAY	BACK DOOR PIN PANEL BACK DOOR BACK DOOR BACK DOOR BACK DOOR
Z 32-P-2700	LOCK RELAY	BACK DOOR

INSTRUCTIONS FOR ALTERING COIN CHUTES EQUIPPED WITH A FLIP-OVER DEVICE.

FOR 1 COIN - FOR 1 PLAY

FIGURE 1

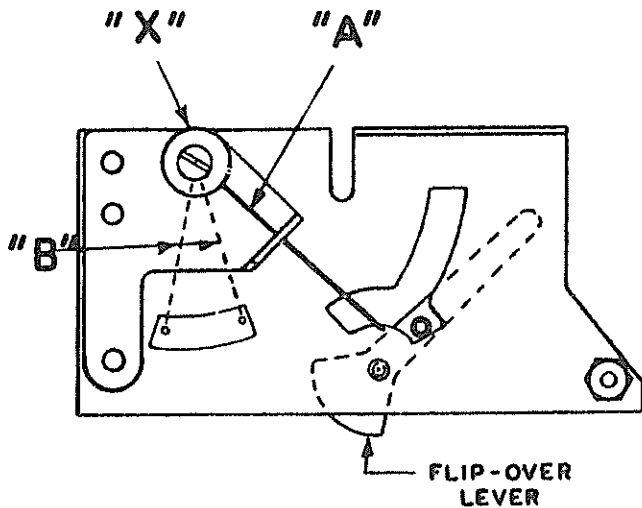

OR 2 COINS - FOR 1 PLAY

FIGURE 2

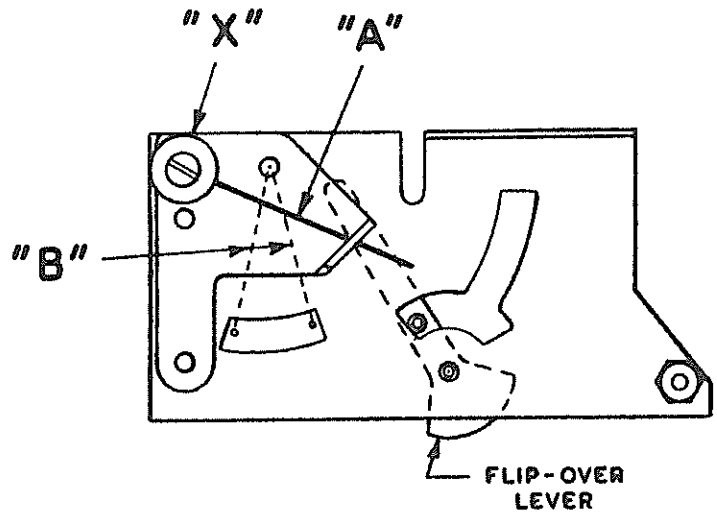

1 COIN - FOR 1 PLAY (FIGURE 1):

Wire form "A" should be in position as shown in Figure 1. Flip-over lever should rebound from wire form "A" and return to position shown in Figure 1 everytime a coin is inserted. All coins pass over the coin trip switch wire "B".

2 COINS - FOR 1 PLAY (FIGURE 2):

Wire form "A" should be in position as shown in Figure 2 (see note). Flip-over lever should alternate from side to side. 1st coin should go to cash box without actuating coin trip switch wire "B", 2nd coin should pass the coin trip switch wire "B" and returns flip-over to position as shown in Figure 2.

NOTE:

To change from 1 coin play to 2 coin play or vice versa - loosen screw "X" and move screw, bushing & wire form "A" to position as required - shown in Figure 1 position as required - shown in Figure 1 or Figure 2.

When using 1 coin for 1 play, wire form "A" should not under any circumstances be allowed to enter the "Banana" slot and cause binding of flip-over lever.

INSTRUCTIONS FOR COIN TRIP SWITCH ADJUSTMENT

WIRE SHOULD BE IN CONTACT WITH END OF CRESCENT OPENING WHEN BLADE ADJUSTMENT IS MADE.

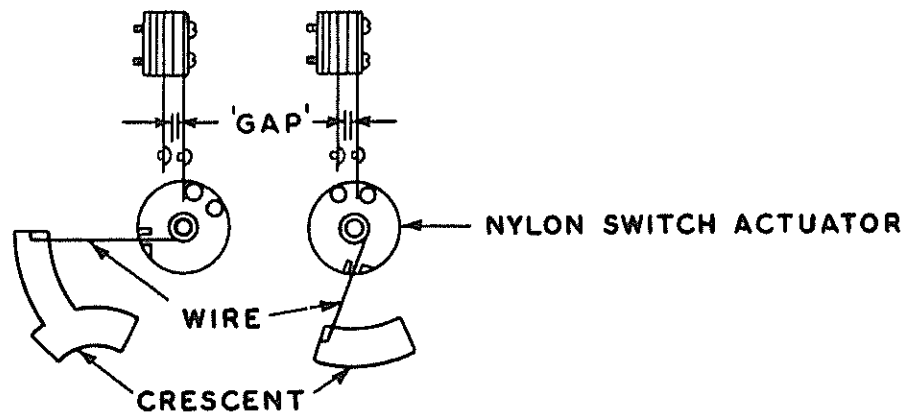

Long blade should be in contact with nylon switch actuator and have a maximum overtravel of $1/32$.

or

Using a gram gauge, tension of long blade should not exceed 10 grams.

SWITCH ADJUSTMENT

1. For small coins, such as dimes, adjust short blade so that the 'gap' between the silver contacts is .045 to .055.
2. For larger & heavier coins the 'gap' should be .045 to .060.
3. Do not adjust 'gap' closer than .040.

PLAYFIELD SWITCHES DIAGRAM

TOP 9 SWITCHES OPERATE 1ST & 2ND BALL RELAYS

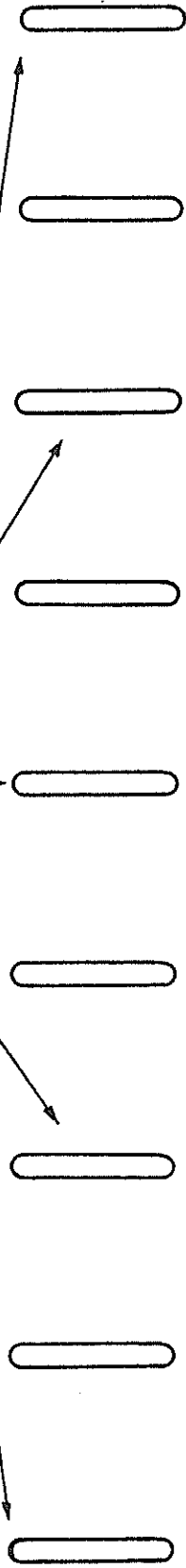

ON THE SPARE SHOT
SWITCHES Q & R TRIP
THE 10 IF HIT
SIMULTANEOUSLY WHEN
THE 1 IS DOWN

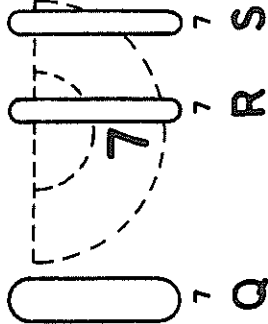

SWITCH T TRIPS THE 10 IF
THE 3 & 9 ARE UP AND
THE 1 IS DOWN

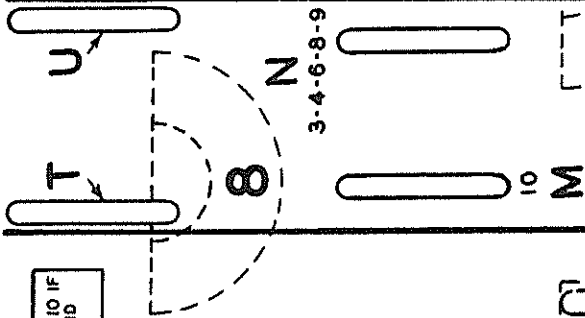

SWITCHES T & U TRIP 10
IF HIT SIMULTANEOUSLY

STRIKE ZONES SWITCHES G, H, M, N, O,
P, T, U, V & W OPERATE ONLY WHEN 1
IS DOWN, HOWEVER IF 1 IS DOWN ON
THE 1ST SHOT, THEY ARE IMPERATIVE
ON THE SPARE SHOT.

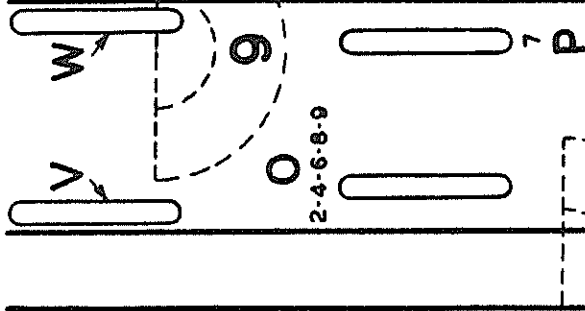

SWITCH W TRIPS THE 7 IF
THE 2 & 8 ARE UP AND
THE 1 IS DOWN

SWITCHES V & W TRIP 7
IF HIT SIMULTANEOUSLY

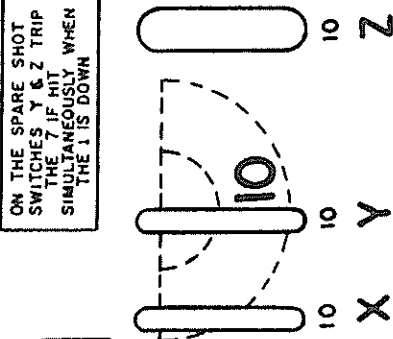

ON THE SPARE SHOT
SWITCHES Y & Z TRIP
THE 7 IF HIT
SIMULTANEOUSLY WHEN
THE 1 IS DOWN

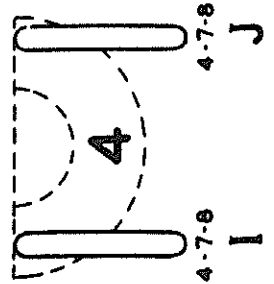

SWITCHES I & J WILL NOT
TRIP 7 IF 4 IS DOWN

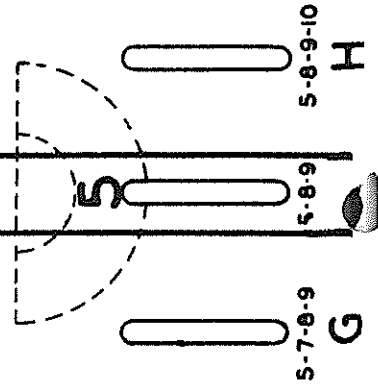

5-7-8-9
G

5-8-9-10
H

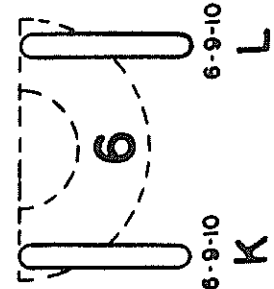

SWITCHES K & L WILL NOT
TRIP 10 IF 6 IS DOWN

6-9-10
K

6-9-10
L

SWITCH F OPERATES ONLY WHEN HIT SIMULTANEOUSLY WITH SWITCH E
SWITCH F ALSO TRIPS 4 WHEN 3 IS UP AND 1 IS DOWN

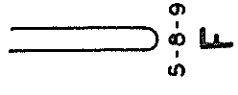

SWITCH E ALSO TRIPS THE 10 WHEN IT HAS BEEN HIT SIMULTANEOUSLY WITH SWITCH F, WHEN 3 IS UP 6 IS DOWN.

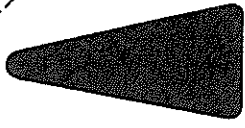
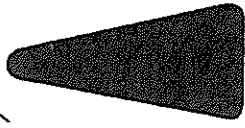
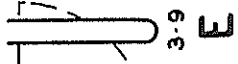

SWITCH D ALSO TRIPS THE 7 WHEN IT HAS BEEN HIT SIMULTANEOUSLY WITH SWITCH C, WHEN 2 IS UP 4 IS DOWN.

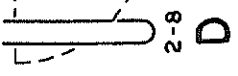

SWITCH C OPERATES ONLY WHEN HIT SIMULTANEOUSLY WITH SWITCH D
SWITCH C ALSO TRIPS 5 WHEN 2 IS UP AND 1 IS DOWN



NOTES
THE 7-10 RAILROAD CAN BE PICKED-UP EASIER BY MOVING THE Z SWITCH TO THE LEFT AND THE Q SWITCH TO THE RIGHT. THESE TWO SWITCHES ARE LOCATED IN WIDE SLOTS WHICH HAVE EXTRA DRILLED HOLES FOR THE NEW Q & Z SWITCHES LOCATIONS
SWITCHES M & P OPERATE IN ACCORDANCE WITH THE STRIKE ZONES CONTROL JACK

STRIKE ZONES



EXPLANATION
N → PLAYFIELD SWITCH LETTER
3-4-6-8-9 → REFERS TO RELAYS TRIPPED
DOWN → MEANS BOWLING PIN IS TRIPPED
UP → MEANS BOWLING PIN IS LATCHED & IN AN EXTENDED POSITION

1. GENERAL

NEVER EXPERIMENT with any of the mechanism. Locate any trouble with the aid of Wiring Diagrams or Operating & Servicing Information supplied with the machine, then check for proper adjustment of the units involved before making any changes. Improper adjustment or make-shift repair will only cause serious damage to other parts of the machine or repeated failure of the part.

NOTE: Always look for a possible loose wire, bad connection at a plug and socket, broken or unhooked springs on step-up units, relays, etc., before adjustments are made or wires reconnected.

2. FUSES

IMPORTANT: Never replace fuses with any rating other than specified on the fuse block; this block is located adjacent to the transformer.

3. LUBRICATION

Over-lubrication causes far more trouble in coin operated equipment than under-lubrication. Practically all cases of poor contact on switches and wiper discs are due to oil or grease, or oil vapor, which forms a film or residue on the contacts and will not allow current to pass through. Excess lubricant may also seep into clutches causing them to slip.

IMPORTANT: NEVER USE VASELINE FOR LUBRICATION OF ANY PART OF THE MACHINE. Vaseline is not a true lubricant. It leaves a dirty and gummy residue and it becomes very thick when cold. A special Coin Machine Lubricant is supplied with each machine.

STEP-UP Levers, Ratchets, Cams, Shafts and other sliding or oscillating parts should be very lightly greased with special Coin Machine Lubricant (supplied with machine) not oftener than every six months. The bakelite discs (biscuits) on the Motor Units and Step-up Units will require lubrication with the special Coin Machine Lubricant only after the grease is completely evaporated (3 to 12 months, depending on climate) or when the film of grease becomes dirty. In either event, clean the parts thoroughly with a solvent, then apply an extremely thin coat of the special grease.

Solenoid Plungers should not have a lubricant of any kind. Should there be a sluggish tendency or if plungers are sticking, the parts should be cleaned with a solvent and flaked graphite applied on reassembly.

SWITCH ADJUSTMENT

BEFORE ADJUSTING SWITCHES, MAKE CERTAIN THE SCREWS HOLDING THE SWITCH STACKS ARE DOWN TIGHTLY. BAKELITE SPACERS IN THE SWITCH STACKS, DUE TO EXCESSIVE MOISTURE, HAVE OCCASIONALLY SHRUNK BY DRYING OUT, CAUSING POOR ADJUSTMENT.

WHAT TO DO IF:

1. Lights are out, game is in-operative:
 - a. Check A.C. cord and plug for breaks, cuts or other damage.
 - b. Check fuses, located on back door.
 - c. Check master switch, located under the front end of the cabinet.
 - d. Check plugs and jacks for proper installation.
2. Lights are on, game is in-operative:
 - a. Check the 15 Amp fuse, heavy Black wire.
 - b. Check plugs and jacks.
3. Lights are out, game operates:
 - a. Check the 15 Amp fuses, heavy White wire and heavy Orange wire.
 - b. Check plugs and jacks.
 - c. Check lite bulbs.
4. Coin is accepted, game is in-operative:
 - a. Check Drop Chute Switch.
 - b. Check coin Relay Coil and Switches.
 - c. Check Start Relay Switch, Black-White to Green-Yellow-White.
 - d. Check switch on Score Motor Relay, Red-White and Green-Yellow-White.
 - e. Check front door Slam Switch.
 - f. Check Coin Chute adjustment jack.
5. Drum Units fail to reset at start of game:
 - a. Check switches on the 'A', 'B', & 'C' Reset Relays.
 - b. Check Zero Position Switches on the Drum Units.
6. Drum Units fail to score properly:
 - a. Check 1-9, 10-90 or 100's Score relay Switches.
 - b. Check Wiper Fingers on Score Motor Disc.
 - c. Check 9th Position Switch on Drums.
7. Game Selection S.U. does not advance to 'Regulation' in reset cycle:
 - a. Check Game Selection S.U. Coil, Gray-Red and Black.
 - b. Check switch on 'B' Reset Relay, Gray-Red and Red-Black.
 - c. Check Game Selection disc., Red-Black. Also, sno-shoe wipers on that unit.
8. Player gets only one shot per frame:
 - a. Check 1st & 2nd Ball Relays.
 - b. Check Score Motor for over-riding.
9. Bowling Pins do not reset:
 - a. Check switch on Pin Reset Relay, Yellow and Gray-Black.
 - b. Check Zero Position Switch on Pin Reset Motor.
10. Game shows "Game Over" in 1st Frame:
 - a. Check Lock Relay.
 - b. Check switches on the Lock Relay.
 - c. Check Tilt Switch for proper adjustment.
 - d. Check Frame Control S.U. Unit for proper resetting.

ROTO S.U. UNIT

THIS UNIT ADVANCES ONE STEP EACH TIME THE ROTO ADVANCE RELAY IS ENERGIZED. ITS FUNCTION IS TO ALLOW THE SAME PLAYER TO SHOOT AGAIN FOR "FLASH" SCORING.

(A-4)

ENERGIZES S.U. COIL ON THIS UNIT,
THRU SWITCH ON START RELAY.

(E-7)

TO "BOWL AGAIN"
LITE

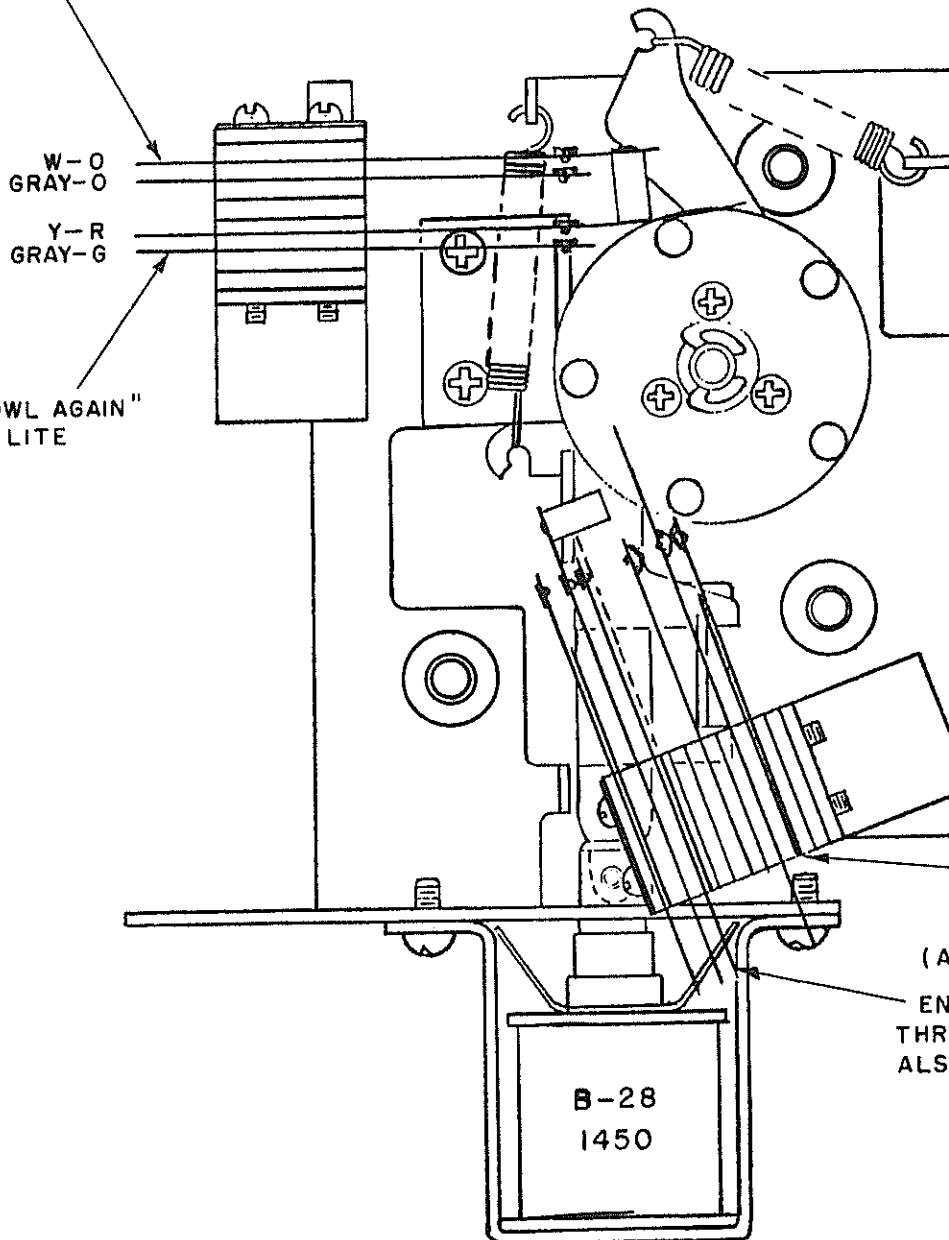

(A-5)

IN CIRCUIT TO 10-90
SCORE RELAY - ALSO
ENERGIZES FLASH RELAY.

(A-4)

ENERGIZES ROTO RELAY,
THRU SWITCH ON STRIKE RELAY -
ALSO RUNS FLASH MOTOR.

B-28
1450

10 STEP 3" DRUM UNIT

LUBRICATION:

Do not put lubricant on drive armature.

Proper lubrication will insure a longer lasting and better operating unit.

Points to be lubricated are the three posts on which the nylon parts to rotate, each tooth of the ratchet, also ratchet cam and top of drive pawl - bracket, indicated by *.

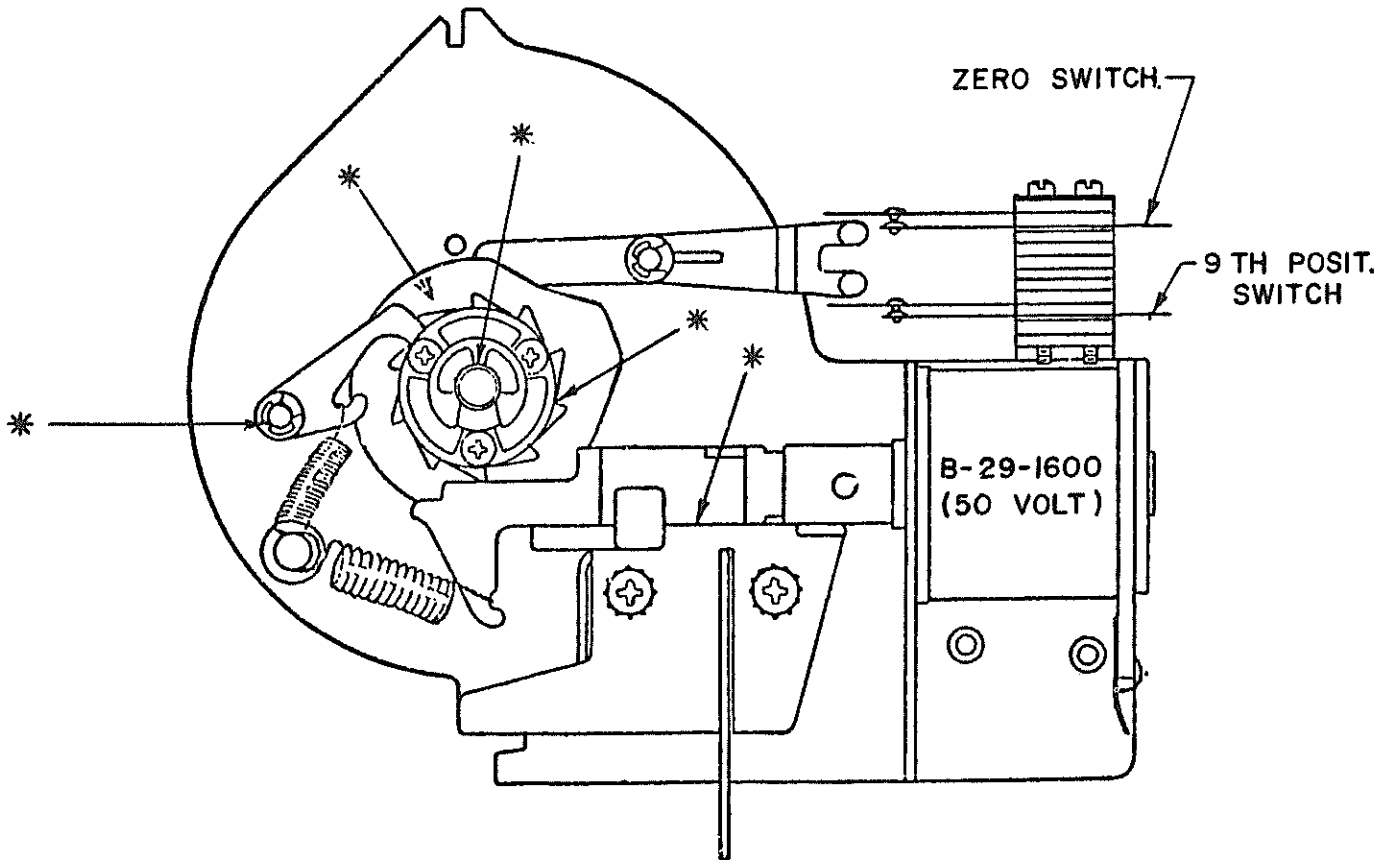

SWITCH ADJUSTMENT:

AT "O" OR INDEX POSITION BOTH SWITCHES ARE OPEN AS SHOWN.

AT 1st TO 8th POSITION TOP SWITCH IS CLOSED. BOTTOM SWITCH REMAINS OPEN.

AT 9th POSITION BOTH SWITCHES ARE CLOSED AS SHOWN.

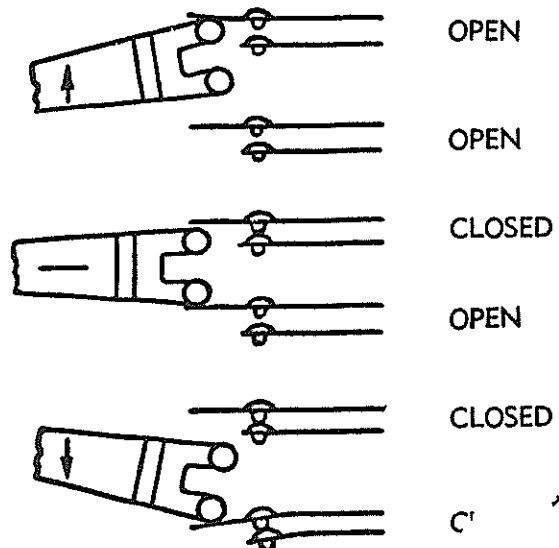

SCORE MOTOR DISC

WITH SCORE MOTOR CAM AT "O" POSITION AND CAM RIDER RESTING AT BEGINNING OF DWELL, WIPER ASSEMBLY SHOULD NOW BE SET SO THAT LONG FINGER IS LINED UP WITH INDEX POINT AS SHOWN.

VIEW LOOKING AT
WIPER FINGERS

INGERS:

- 6 UNROUNDED
- 4 & 5 INSULATED
- 7 INSULATED

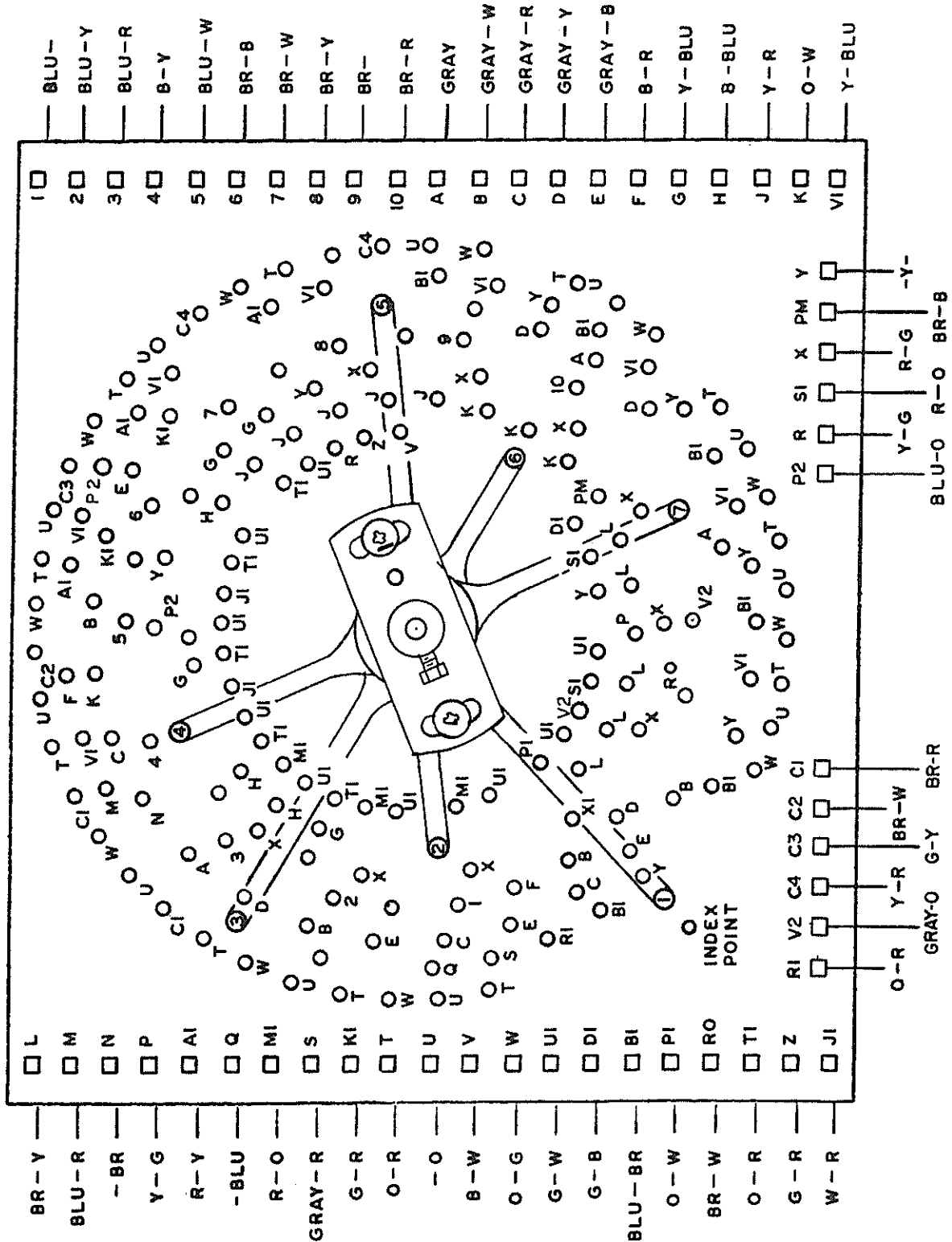

INGERS:

- 6 UNROUNDED
- 4 & 5 INSULATED
- 7 INSULATED

SCORE MOTOR DISC

Diagram Location	Description	Diagram Location
L B-B	PULSES STRIKES-SPARE RESET RELAY THRU "C" OR "E" POSITIONS ON STRIKE-SPARE UNIT DISCS.	A-9
M C-10	IN CIRCUIT TO STRIKE RELAY FROM "D1" RIVET.	A-10
N D-12	TO PLAYER RESET RELAY FROM "PM" RIVET.	A-10
P B-8	PULSES STRIKE-SPARE RESET RELAY WHEN SPARE FOLLOWS A STRIKE.	A-10
AL A-5	3 RIVETS TO PULSE 10-90 RELAY IN "STRIKE 90" & "ROTO".	A-10
Q C-12	OPERATES EXTRA SHOTS RESET RELAY FROM "V" RIVET.	A-10
ML A-6	IN CIRCUIT TO 100'S SCORE RELAY, FROM FLASH MOTOR DISC.	A-10
S B-9	TO PIN RESET RELAY FROM "Z" RIVET.	A-10
KL A-8	IN CIRCUIT TO STRIKE-SPARE RESET RELAY IN "FLASH".	A-10
T A-3	11 RIVETS TO PULSE "C" RESET RELAY AT START OF GAME.	A-10
U A-3	11 RIVETS TO PULSE "B" RESET RELAY AT START OF GAME.	A-10
V C-12	FEEDS "Q" RIVET FROM CIRCUITS WHICH ORIGINATE IN THE EXTRA SHOTS UNIT DISC.	A-10
W A-3	11 RIVETS TO PULSE "A" RESET RELAY AT START OF GAME.	A-10
UL A-5	(9) RIVETS TO FEED "A1" & "B1" RIVETS.	A-10
D1-9	FEEDS "M" RIVET IN ALL GAMES EXCEPT "REGULATION".	A-10
BL A-5	6 RIVETS TO PULSE 10-90 RELAY IN "STRIKE 90" & "ROTO".	A-10
PL A-6	CIRCUIT TO 100'S SCORE RELAY THRU FLASH MOTOR DISC.	A-10
RO D-8	TRIPS ROLLOVER SWITCHES CONTROL RELAY, THRU SWITCH ON #1 RELAY.	A-10
TL B-8	IN CIRCUIT TO STRIKE-SPARE RESET RELAY AT START OF GAME.	A-10
Z B-9	FEEDS RIVET "S" FROM SWITCH ON SCORE CONTROL RELAY.	A-10
JL A-7	IN CIRCUIT TO 100'S SCORE RELAY, THRU FLASH MOTOR DISC.	A-10
RL A-6	IN CIRCUIT TO ENERGIZE ROTO ADVANCE RELAY.	A-10
V2 B-7	CIRCUIT TO 100'S SCORE RELAY IN 'STRIKE-SPARE BONUS'.	A-10
CL4	USED IN MULTIPLE COIN CIRCUIT ONLY.	A-10
13		A-10
A-6	FEEDS 'R1' RIVET IN "ROTO".	D-12
7	FEEDS 'V2' FROM FLASH MOTOR DISC.	A-9
		A-10
		A-6
		SL
		A-9
		A-10
		A-6
		A-8
		A-7
		A-8
		A-9
		B-7
		B-7
		B-8
		B-8
		A-6
		D-12
		A-9
		A-10
		A-6
		SL

FROM SWITCH ON R.O. SW. CONTROL RE.

FROM SW. ON 2 RELAY.

FROM SW. ON 3 RELAY.

FROM SW. ON 4 RELAY.

FROM SW. ON 5 RELAY.

FROM SW. ON 6 RELAY.

FROM SW. ON 7 RELAY.

FROM SW. ON 8 RELAY.

FROM SW. ON 9 RELAY.

FROM SW. ON 10 RELAY

3 RIVETS-IN CIRCUITS TO 10-90 SCORE RE., STRIKE-SPARE RESET RE., & SCORE CONTROL RE.

4 RIVETS-SAME AS "A" (ABOVE).

3 RIVETS-IN CIRCUITS TO 10-90 SCORE RE. & STRIKE-SPARE RESET RELAY.

4 RIVETS-SAME AS "A" (ABOVE).

4 RIVETS-SAME AS "C" (ABOVE).

2 RIVETS PULSE THE STRIKE-SPARE ADVANCE RELAY ON A STRIKE. (1 RIVET ON A SPARE).

PULSES 10-90 SCORE RELAY, ON 1st SHOT, WHEN PLAYER IS HOLDING A SPARE OR TWO STRIKES. ALSO, WHEN A BLOW FOLLOWS A STRIKE.

ENERGIZES SCORE CONTROL RELAY, ON 1st SHOT, WHEN PLAYER IS HOLDING A SPARE OR TWO STRIKES. ALSO, WHEN A BLOW FOLLOWS A STRIKE.

5 RIVETS TO PULSE 10-90 SCORE RELAY. 2 OF THESE RIVETS ON A STRIKE-SPARE OR SPARE-STRIKE COMBINATION. 3 RIVETS ON THREE STRIKES.

TO PULSE STRIKE-SPARE RESET RELAY, ON 1ST SHOT, WHEN PLAYER IS HOLDING A SPARE OR TWO STRIKES. ALSO, WHEN A BLOW FOLLOWS A STRIKE.

8 RIVETS PULSE 100'S SCORE RELAY IN "ROTO" AND "FLASH".

50 VOLT COMMON.

FEEDS "N" RIVET FROM COIN S.U. DISC & PLAYER S.U. DISC.

10 RIVETS TO PULSE THE 1-9 SCORE RELAY.

IN CIRCUIT TO 100'S SCORE RELAY.

PULSES 1-9 SCORE RELAY THRU X RIVETS.

THESE WIRES CONNECT TO THE A-B-C-D-E LUGS ON ALL 6 STRIKE-SPARE UNIT DISCS.

SCORE MOTOR SWITCHES

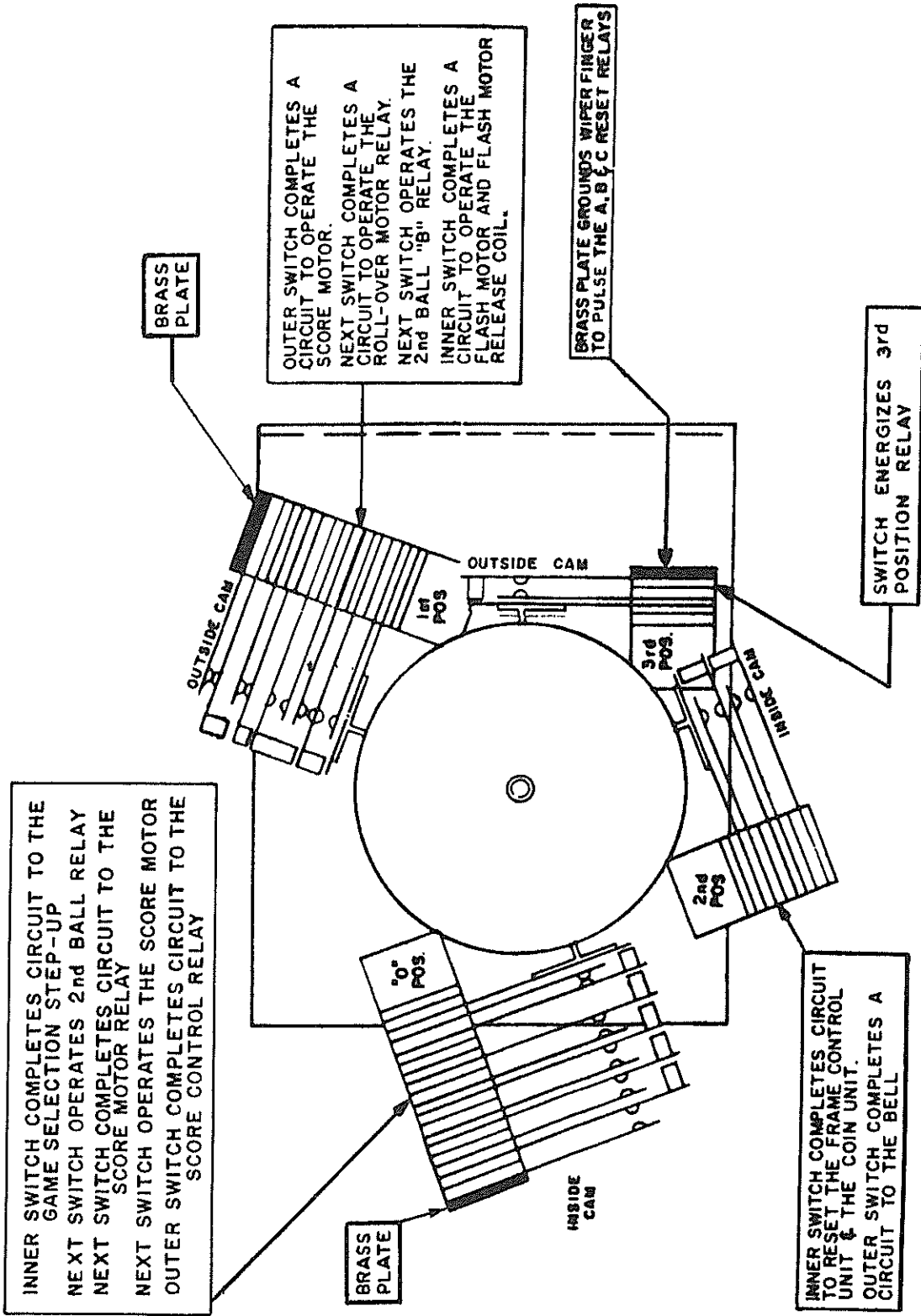

COIN S.U. UNIT DISC

THIS UNIT RESETS AT THE START OF A NEW GAME, AND ADVANCES EVERY TIME THE COIN RELAY IS PULSED

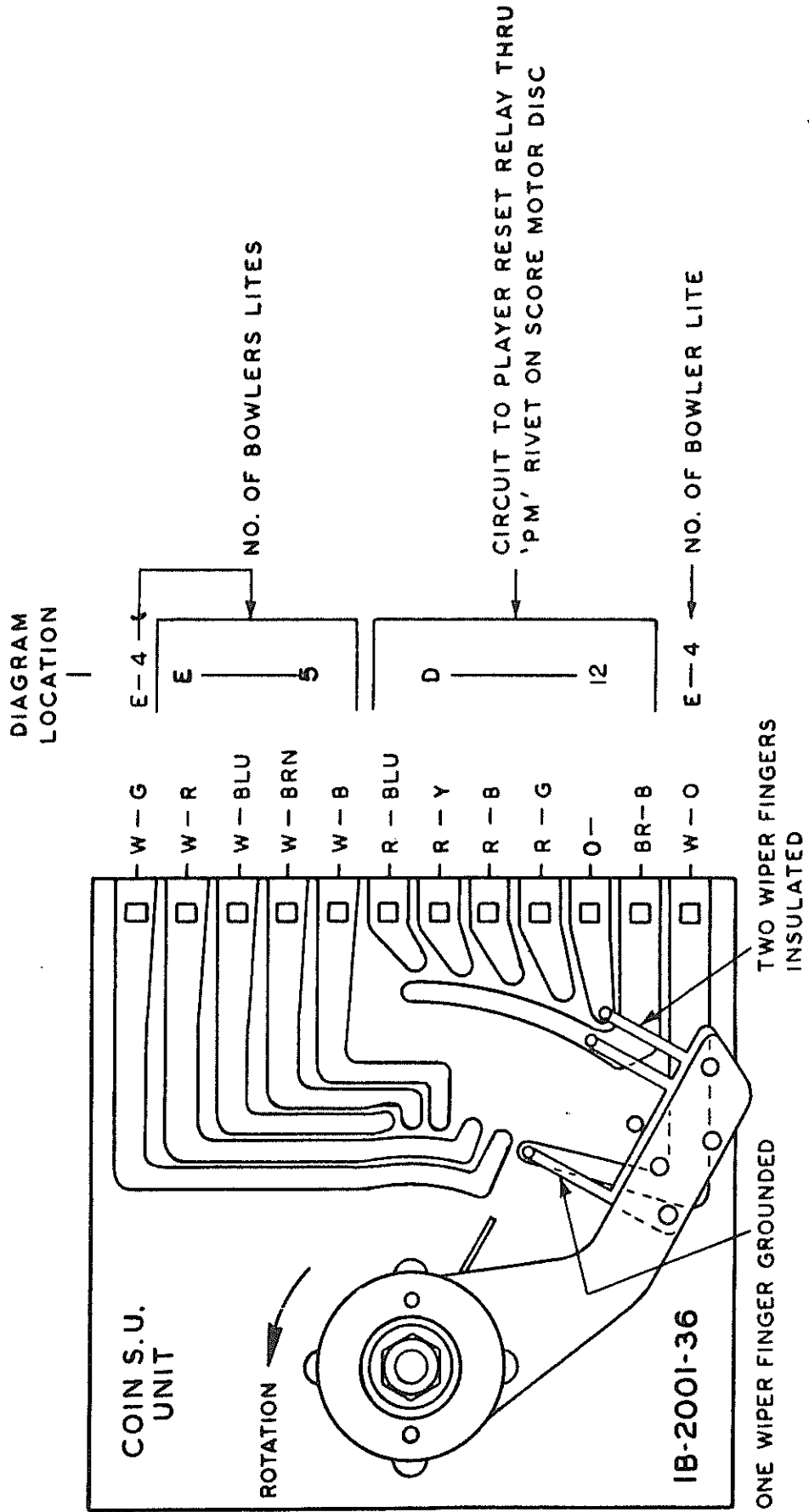

VIEW LOOKING AT WIPER FINGER SIDE

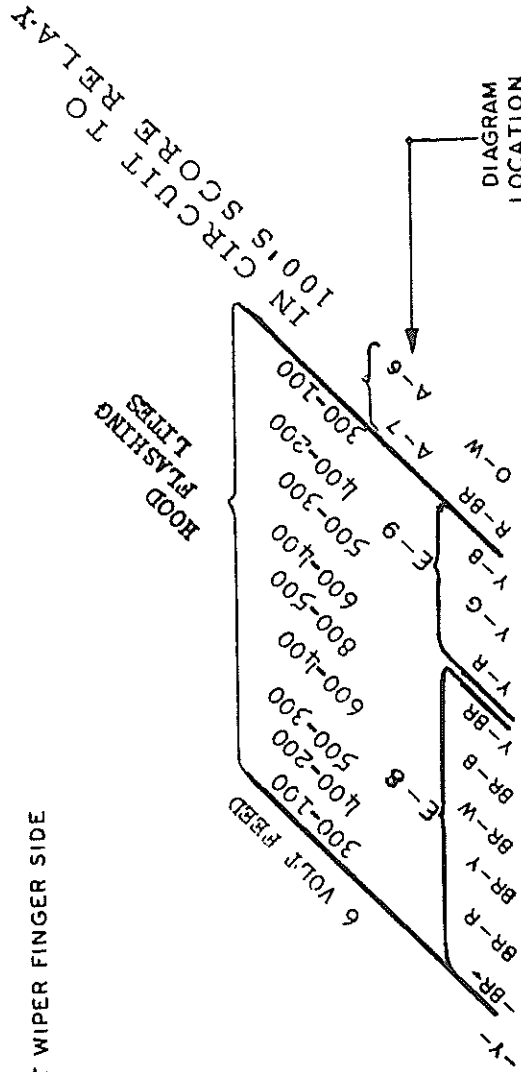

FLASH MOTOR DISC

THIS UNIT COMPLETES CIRCUITS TO 100'S SCORE RELAY IN 'ROTO', 'FLASH' AND 'STRIKE-SPARE BONUS'.

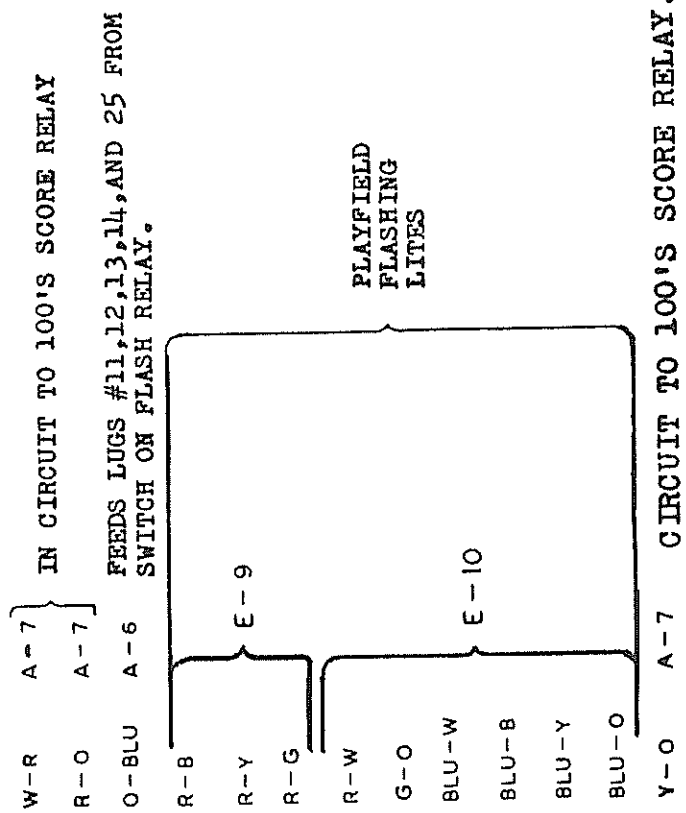
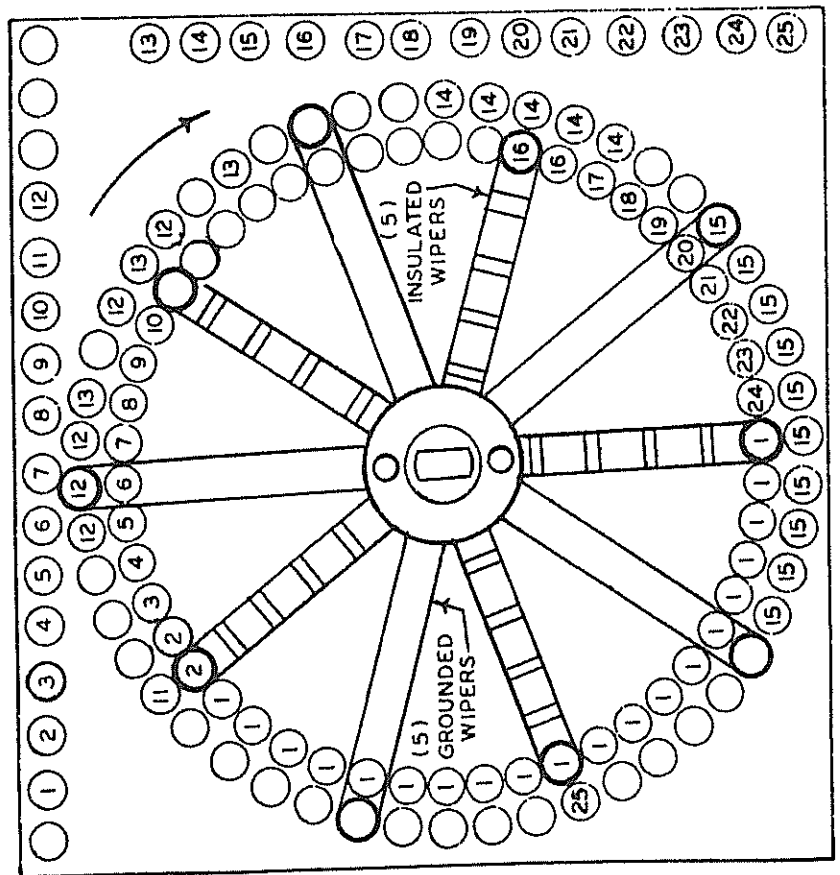

IN CIRCUIT TO 100'S SCORE RELAY

FEEDS LUGS #11,12,13,14, AND 25 FROM SWITCH ON FLASH RELAY.

PLAYFIELD FLASHING LITES

CIRCUIT TO 100'S SCORE RELAY.

EXTRA SHOTS UNIT DISC

THIS UNIT OPERATES IN THE 10th FRAME IN 'REGULATION', 'FLASH' AND 'STRIKE-SPARE BONUS'. IT ADVANCES TWO TIMES PER STRIKE AND ONCE ON A SPARE. THE FUNCTION OF THIS UNIT IS TO GIVE EXTRA SHOTS TO THE PLAYER.

DIAGRAM
LOCATION

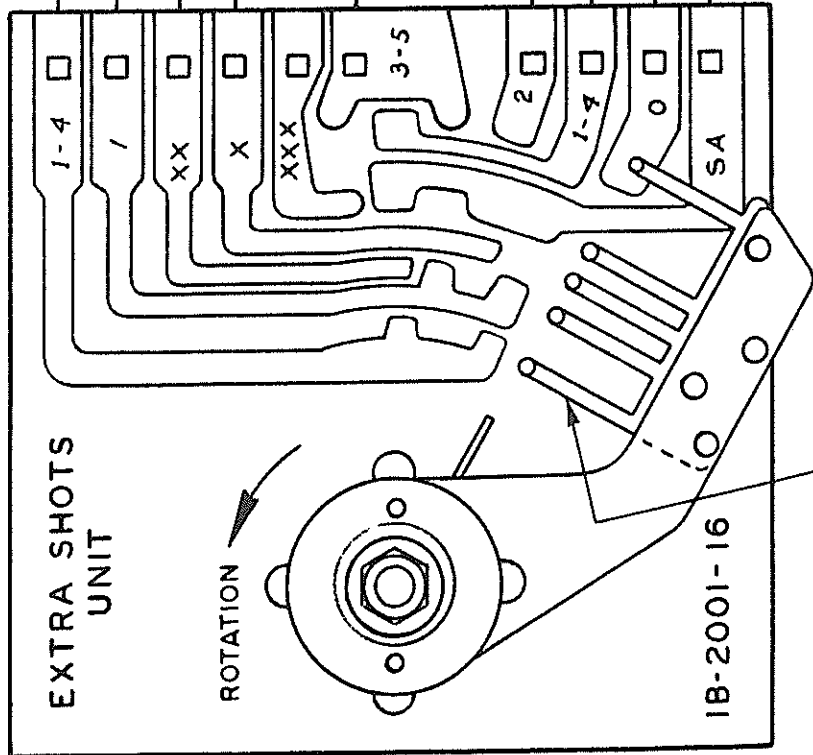

O - B (D - 11) RUNS SCORE MOTOR THRU SW. ON 1ST BALL RELAY OR ZERO POSITION CAM SW. ON SCORE MOTOR

W - G (E - 7) SPARE LITE

W - R (E - 7) 2ND STRIKE LITE

W - O (E - 7) 1ST STRIKE LITE

B - W (D - 12) TO 'V' RIVET ON SCORE MOTOR DISC

O - G (D - 12) TO SWITCH ON 2ND BALL RELAY.

G - Y (D - 12) TO SWITCH ON I-10 RELAY

R - B (D - 12) TO SWITCH ON SCORE CONTROL RELAY

Y - R (E - 7) 'BOWL AGAIN' LITE

IN CIRCUIT TO EXTRA SHOTS RESET RELAY, WHICH IN TURN CONTROLS POWER TO 3RD PO RELAY. (SWITCH C)

FIVE WIPER FINGERS GROUNDED TO YELLOW VIEW LOOKING AT WIPER FINGER SIDE AND WITH WIPER IN RESET, OR ZERO POSITION

PLAYER UP DISC

DIAGRAM LOCATION

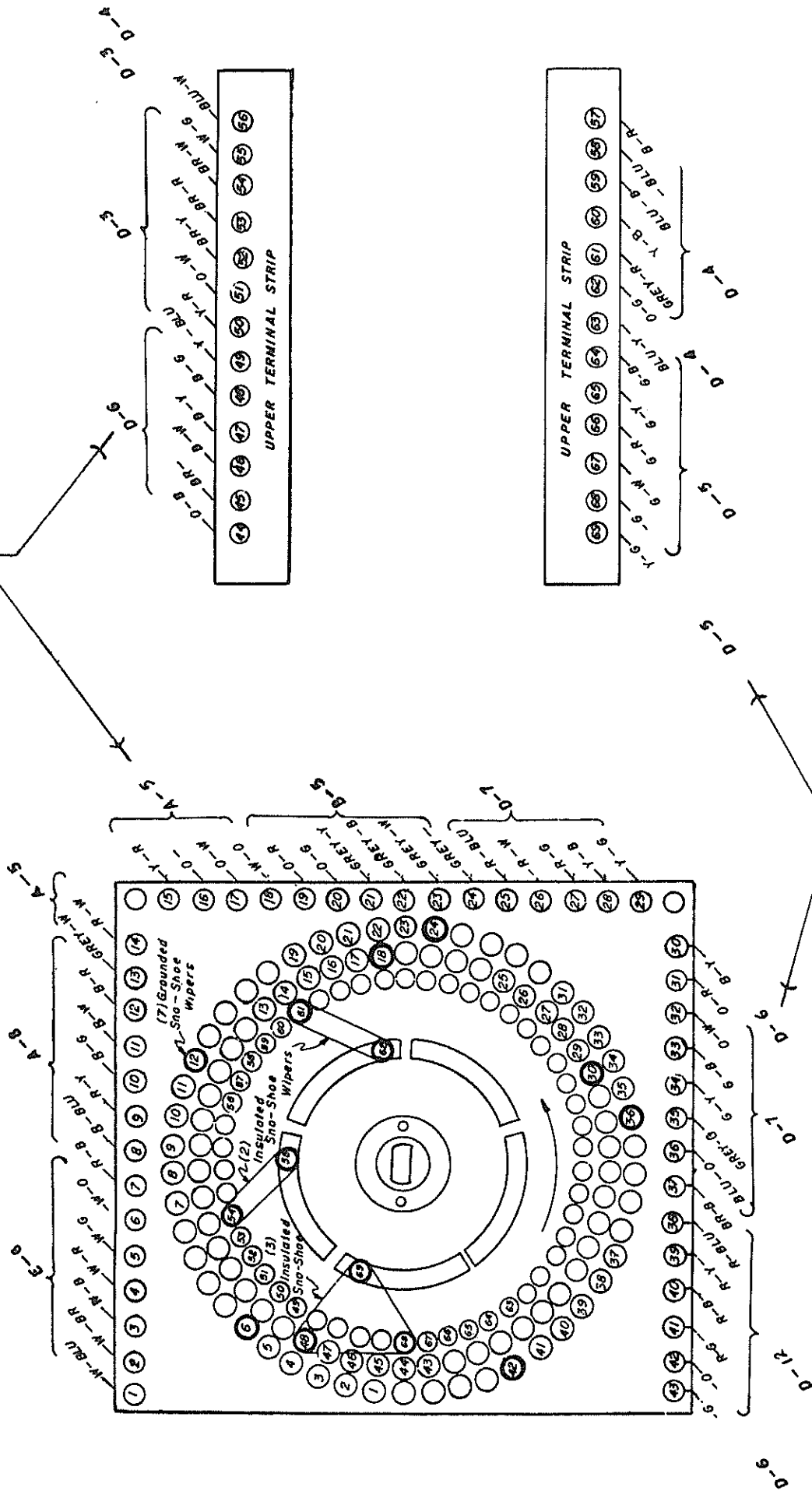

DIAGRAM LOCATION

View looking at SNO-SHOEWiper fingers,
with wipers in ZERO position
or 1st PLAYER UP

PLAYER UP UNIT DISC

LUG	LUG
1	37
2	38
3	39
4	40
5	41
6	
7	42
8	43
9	44
10	45
11	46
12	47
13	48
14	49
15	50
16	51
17	52
18	53
19	54
20	55
21	56
22	57
23	58
24	59
25	60
26	61
27	62
28	63
29	64
30	65
31	66
32	67
33	68
34	69
35	
36	

TO PLAYER UP LITES

IN CIRCUIT TO ENERGIZE PLAYER RESET RELAY.

IN CIRCUITS TO SCORE CONTROL RELAY, STRIKE-SPARE RESET RELAY, & 10-90 SCORE RELAY IN "REGULATION" GAME. THESE WIRES CONNECT TO THEIR RESPECTIVE STRIKE-SPARE UNIT DISCS.

IN CIRCUIT TO ENERGIZE GAME SELECTION S.U. COIL.

IN CIRCUIT TO 100's SCORE RELAY THRU 9th POSITION SWITCHES ON 10-90 DRUM UNITS.

TO 1000 DRUM S.U COILS, THRU 9th POSITION SWITCHES ON 100's DRUM UNITS.

IN CIRCUIT TO 10-90 SCORE RELAY THRU 9th POSITION SWITCHES ON 1-9 DRUM UNITS.

THESE WIRES CONNECT TO 1-9 DRUM S. U. COILS.

FEEDS 49 to 54 FROM SW. ON 1-9 SCORE RE.

TO STRIKE-SPARE UNIT RESET COILS THRU ZERO POSITION SWITCHES ON THOSE UNITS.

THESE WIRES CONNECT TO 10-90 DRUM S. U. COILS.

FEEDS 56 to 61 FROM SW. ON 10-90 SCORE RE.

IN CIRCUIT TO STRIKE-SPARE S. U. COILS.

THESE WIRES CONNECT TO THE 100's DRUM UNIT COILS.

FEEDS 43 to 48, And 63 to 68 Thru Sw. on 100's Re.

STRIKE-SPARE UNIT — 1ST PLAYER

THERE ARE (6) SIX STRIKE-SPARE UNITS — ONE FOR EACH PLAYER. THE DISCS ARE IDENTICAL. THE TOP 3 WIRE COLORS (STRIKE AND SPARE LITES) TO THE OTHER FIVE STRIKE-SPARE DISCS ARE SHOWN ON DIAGRAM AT E-II TO E-14. THE "PU" POSITION WIRES (FEEDS FROM PLAYER UP DISC) TO THE OTHER FIVE DISCS ARE SHOWN AT A-B ON DIAGRAM.

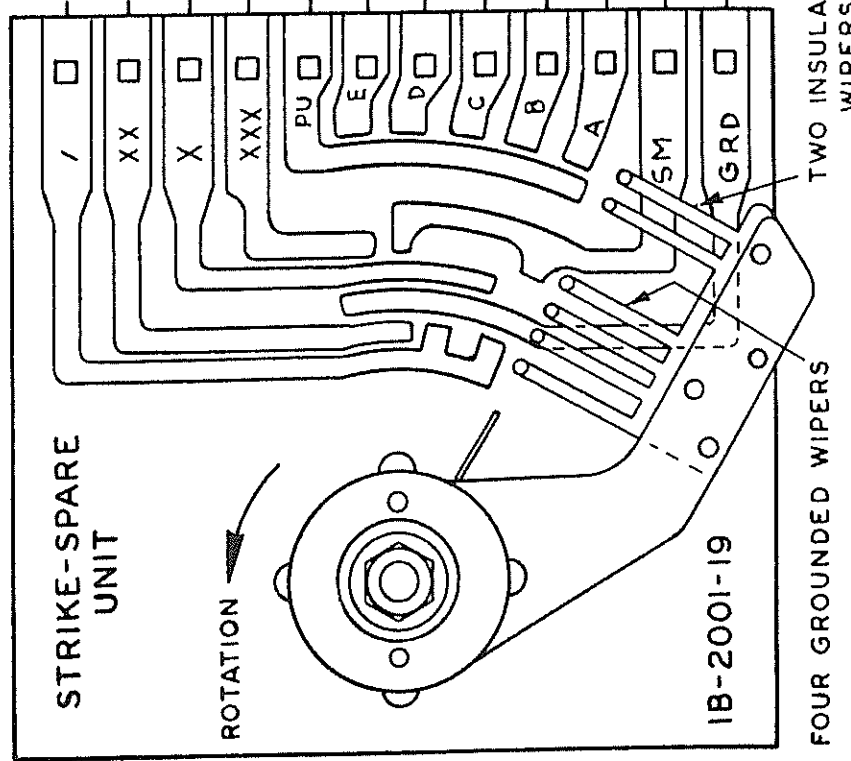
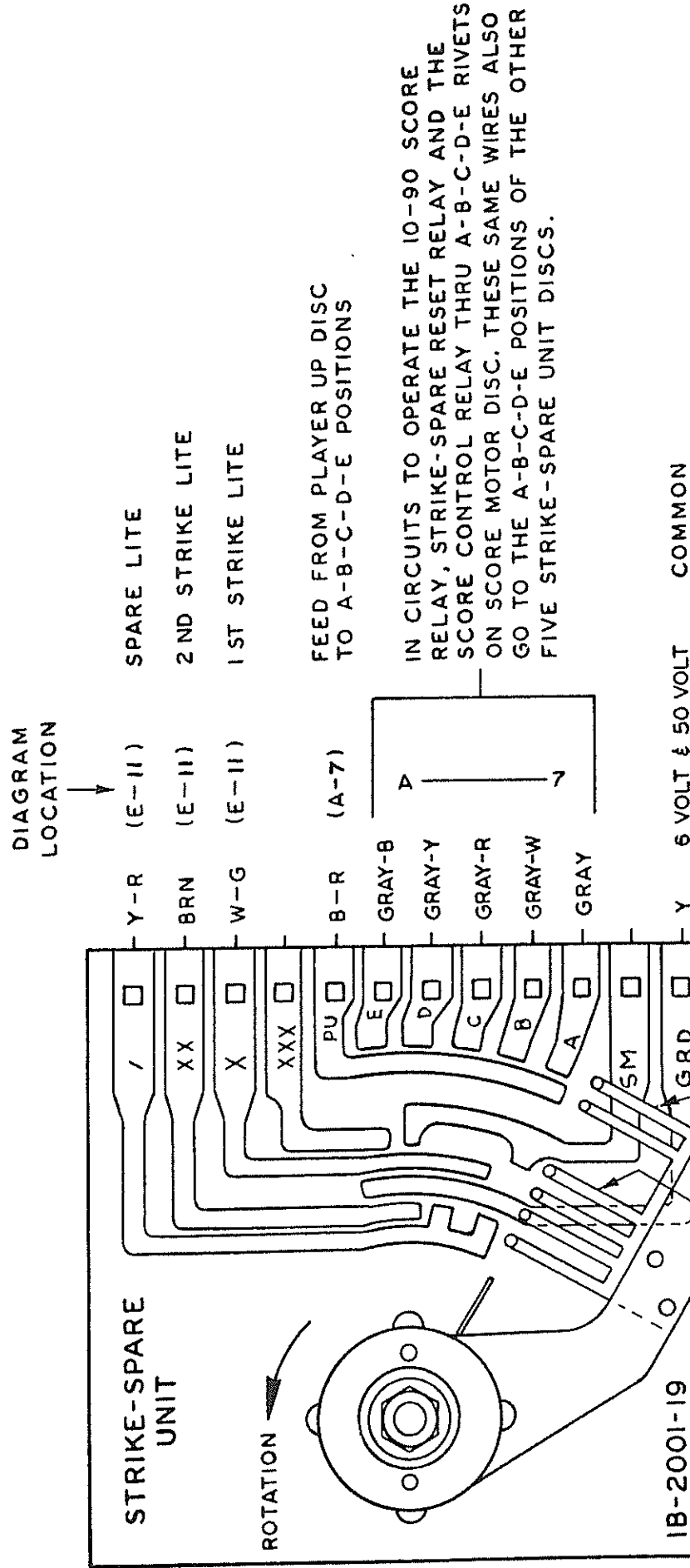

FRAME CONTROL S.U. UNIT

THIS UNIT ADVANCES ONE STEP EACH TIME THE LAST PLAYER COMPLETES HIS TURN. IT RESETS TO ZERO POSITION WHEN START RELAY IS TRIPPED, DURING RESET CYCLE.

VIEW LOOKING AT WIPER FINGERS, WITH WIPER IN RESET POSITION.

C-7 CIRCUIT TO 5TH PLAYER STRIKE-SPARE RESET COIL.
 D-10 CIRCUIT TO EXTRA SHOTS RESER RELAY.
 E-10 TO "BEER FRAME" LITE, THRU ADJUSTMENT JACK.
 E-10 TO "BEER FRAME" LITE, THRU ADJUSTMENT JACK.
 E-10 TO "BEER FRAME" LITE, THRU ADJUSTMENT JACK.
 E-10 TO "BEER FRAME" LITE, THRU ADJUSTMENT JACK.

DIAGRAM LOCATIONS

R-W
 B-W
 W-B
 W-G
 W-O

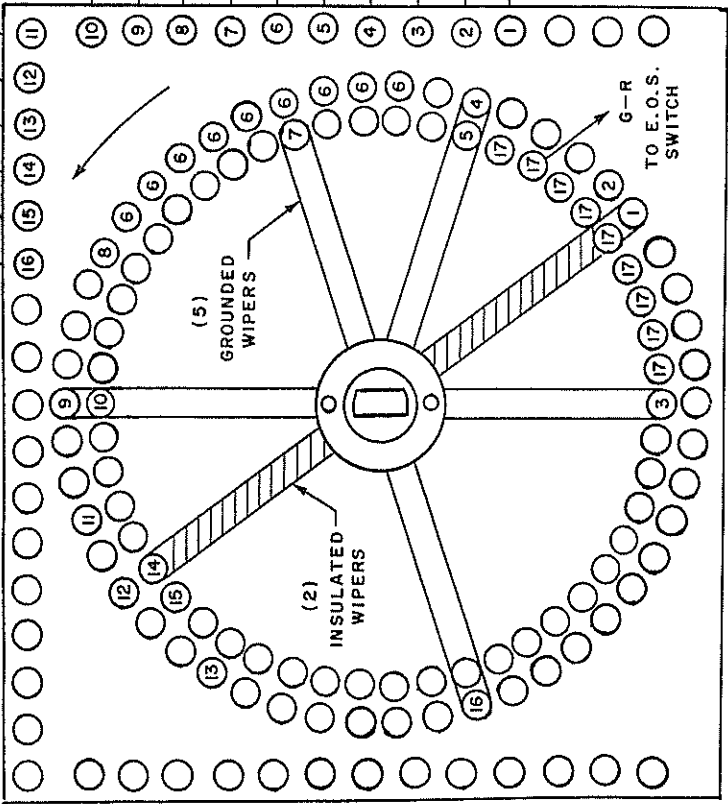

EMERGIZES EXTRA SHOTS S.U. THRU SWITCH ON STRIKE-SPARE ADVANCE RELAY.
 IN CIRCUIT TO 2ND PLAYER STRIKE-SPARE RESET COIL.
 TRIPS GAME-OVER RELAY.
 IN CIRCUIT TO 6TH PLAYER STRIKE-SPARE RESET COIL.
 TO START RELAY COIL.
 TO 10TH FRAME LITE.
 IN CIRCUIT TO 3RD PLAYER STRIKE-SPARE RESET COIL.
 IN CIRCUIT TO 4TH PLAYER STRIKE-SPARE RESET COIL.
 IN CIRCUIT TO GAME SELECTION S.U. COIL.
 50 VOLT FEED.

SPINS COUNTER CLOCKWISE TO ADVANCE FRAME

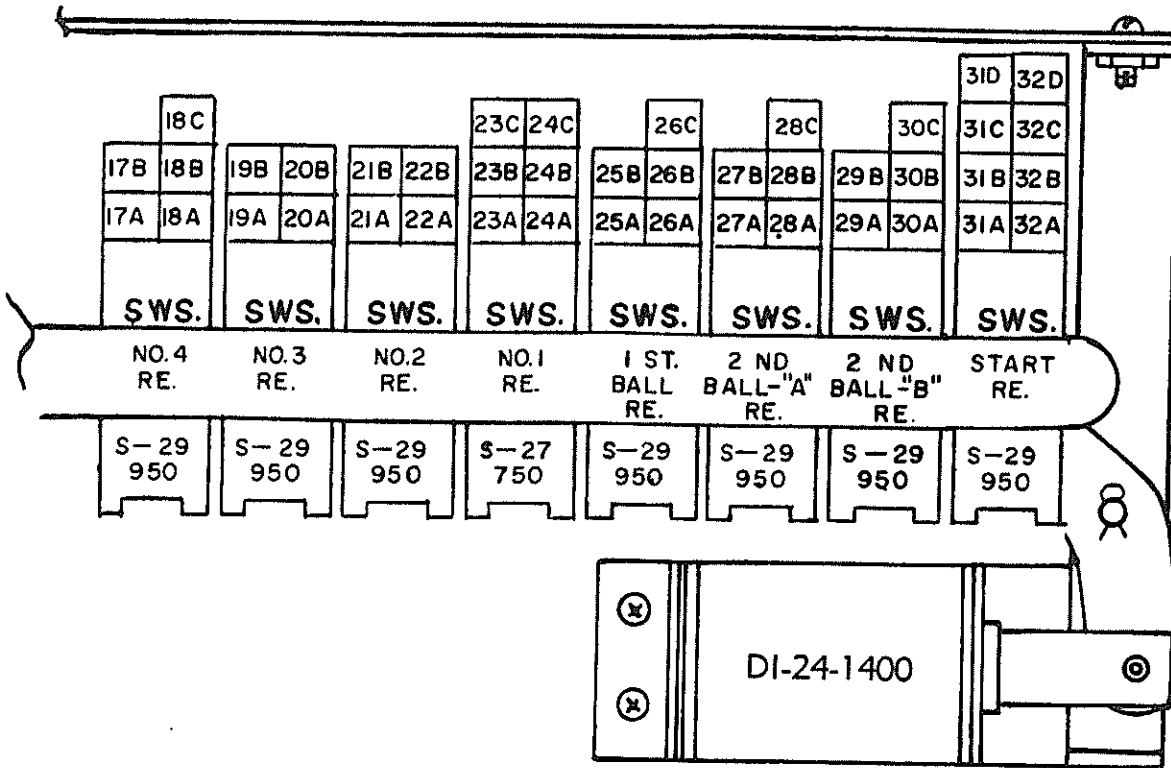
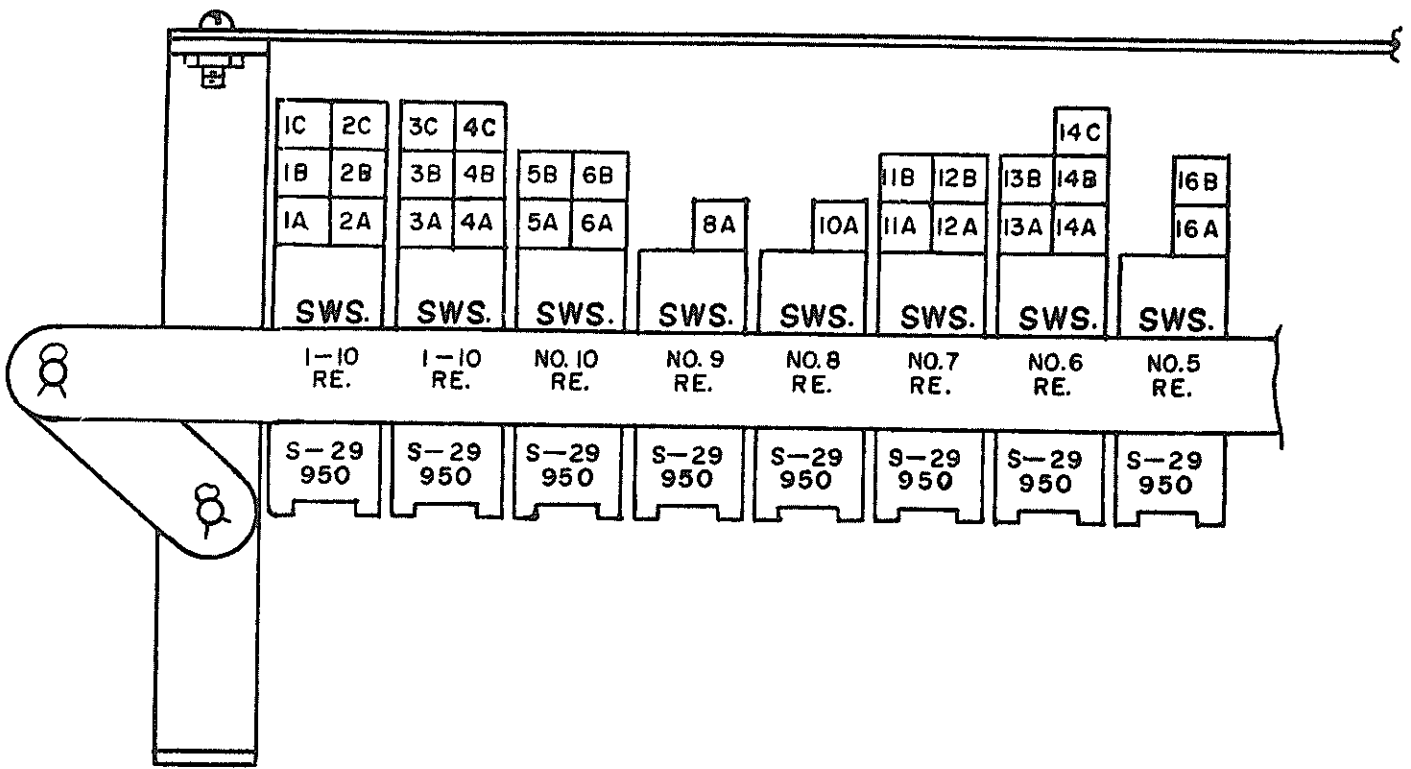

RELAY BANK SWS.

RELAY	SW.	WIRE COLORS	DIAG. LOC.	TYPE	SWITCH OPERATION
1-10 RELAY	1C	GRAY-BR O-B	D-11	N.O.	RUNS SCORE MOTOR THRU SWITCH ON SCORE MOTOR RELAY.
	1B	-B- B-O	B-9	N.C.	OPENS CIRCUIT TO SCORE CONTROL RELAY AND FLASH MOTOR.
	1A	O-W BR-Y	B-8	N.C.	IN CIRCUIT TO STRIKE-SPARE RESET RELAY, THRU 'K' RIVETS ON SCORE MOTOR.
	2C	G-Y B-W	D-12	N.C.	IN CIRCUIT TO EXTRA SHOTS RESET RELAY, IN 10TH FRAME, AFTER ONE OR TWO STRIKES
	2B	-J- -J-	B-4	N.C.	SAFETY SWITCH TO THIS RELAY COIL.
	2A	Y-BLU R-G Y-R	B-7	M&B	CIRCUIT TO 10-90 SCORE RELAY, FROM 3 'G' OR 5 'J' RIVETS ON SCORE MOTOR. "REGULATION" OR "STRIKE SPARE BONUS".
1-10 RELAY	3C	-G- BLU-BR	B-5	N.O.	IN CIRCUIT TO 10-90 SCORE RELAY, IN "STRIKE-90" OR "ROTO".
	3B	W-R BLU-Y	B-6	N.O.	IN CIRCUIT TO 100'S SCORE RELAY, IN "ROTO" OR "FLASH".
	3A	R-B G-B	C-10	N.O.	ENERGIZES STRIKE RELAY, THRU 'M' & 'D1' RIVETS ON SCORE MOTOR.
	4C	BR-B W-G	C-11	N.O.	ENERGIZES BELL COIL AT 2ND POSITION CAM SWITCH ON SCORE MOTOR.
	4B	-J- -J-	B-4	N.C.	SAFETY SWITCH TO THIS RELAY COIL.
	4A	R-O -GRAY- -G-O	B-9	M&B	OPENS IN CIRCUIT TO 1-9 SCORE RELAY AND CLOSSES TO STRIKE-SPARE ADVANCE RELAY.
# 10 RELAY	5B	BLU-Y -J-	A-12	N.C.	IN CIRCUIT TO 10 PIN COIL, ON SECOND SHOT, WHEN PLAYER HAS A 3-10 LEAVE.
	5A	BR-G -Y-B-	B-13	N.C.	IN CIRCUIT TO 7 PIN COIL, ON SECOND SHOT, WHEN PLAYER HAS A 7-10 LEAVE.
	6B	-J- -J-	B-4	N.O.	IN SERIES CIRCUIT TO TRIP 1-10 RELAYS.
	6A	-J- O-B BR-R	A-10	M&B	IN CIRCUIT TO TRIP #10 RELAY-ALSO TO PULSE 1-9 SCORE RELAY.
#9 RELAY	8A	-J- BLU-B -BR-	A-10	M&B	IN CIRCUIT TO TRIP #9 RELAY---ALSO TO PULSE 1-9 SCORE RELAY.

RELAY	SW.	WIRE COLORS	DIAG. LOC.	TYPE	SWITCH OPERATION
#8 RELAY	10A	-J- B-Y BR-Y	A-10	M&B	OPENS IN CIRCUIT TO #8 RELAY AND CLOSES TO PULSE 1-9 SCORE RELAY.
#7 RELAY	11B	R-G -J-	A-12	N.C.	IN CIRCUIT TO 7 PIN COIL, ON SECOND SHOT, WHEN PLAYER HAS A 2-7 LEAVE.
	11A	BR-G Y-R	B-13	N.C.	IN CIRCUIT TO 10 PIN COIL, ON SECOND SHOT, WHEN PLAYER HAS A 7-10 LEAVE.
	12B	-J- -J-	A-4	N.O.	IN SERIES WITH SWITCH 6B ON #10 RELAY.
	12A	-J- B-G BR-W	A-10	M&B	OPENS IN CIRCUIT TO #7 RELAY AND CLOSES TO 1-9 SCORE RELAY.
#6 RELAY	13B	-J- -J-	A-4	N.O.	IN SERIES WITH SWITCH 12B ON #7 RELAY.
	13A	-J- -J- -J-	A-12	M&B	OPENS IN CIRCUIT TO SWITCH 24A ON #1 RELAY AND CLOSES TO SWITCH 5B ON #10 RELAY.
	14C	O-R BLU-Y	B-13	N.C.	TO 10 PIN COIL FROM 'K' OR 'L' ROLL-OVER SWITCH.
	14B	BLU-R -J-	A-12	N.C.	IN SERIES WITH SWITCH 23A ON #1 RELAY.
	14A	-J- R-BLU BR-B	A-10	M&B	OPENS IN CIRCUIT TO #6 RELAY COIL AND CLOSES TO PULSE 1-9 SCORE RELAY.
#5 RELAY	16B	-J- -J-	A-4	N.O.	IN SERIES WITH SWITCH 13B ON #6 RELAY.
	16A	-J- R-Y BLU-W	A-10	M&B	OPENS IN CIRCUIT TO #5 RELAY COIL AND CLOSES TO 1-9 SCORE RELAY.
#4 RELAY	17B	-J- -J-	A-4	N.O.	IN SERIES WITH SWITCH 16B ON #5 RELAY.
	17A	B-O -J- -J-	A-12	M&B	OPENS IN SERIES CIRCUIT TO SWITCH 23A ON #1 RELAY AND CLOSES TO SWITCH 11B ON #7 RELAY.

RELAY	SW.	WIRE COLORS	DIAG. LOC.	TYPE	SWITCH OPERATION
#4 RELAY	18C	G-W R-G	B-13	N.C.	ENERGIZES 7 PIN COIL THRU 'I' OR 'J' ROLLOVER SWITCH.
	18B	Y-G -J-	A-12	N.C.	IN SERIES WITH SWITCH 24A ON #1 RELAY.
	18A	-J- O-W B-Y	A-10	M&B	OPENS IN CIRCUIT TO #4 RELAY COIL AND CLOSES TO 1-9 SCORE RELAY.
#3 RELAY	19B	R-B BLU-Y	B-13	N.C.	IN CIRCUIT TO 10 PIN COIL, THRU 'T' ROLLOVER SWITCH.
	19A	GRAY-W -J-	B-12	N.C.	IN SERIES WITH SWITCH 13A ON #6 RELAY.
	20B	-J- -J-	A-4	N.O.	IN SERIES WITH SWITCH 17B ON #4 RELAY.
	20A	-J- O-G BLU-R	A-9	M&B	OPENS IN CIRCUIT TO #3 RELAY COIL AND CLOSES TO 1-9 RELAY.
#2 RELAY	21B	B-R -J-	B-12	N.C.	IN SERIES WITH SWITCH 17A ON #4 RELAY.
	21A	R-W R-G	A-13	N.C.	ENERGIZES 7 PIN COIL, THRU 'W' ROLLOVER SWITCH.
	22B	-J- -J-	A-4	N.O.	IN SERIES WITH SWITCH 20B ON #3 RELAY.
	22A	-J- O-R BLU-Y	A-9	M&B	OPENS IN CIRCUIT TO #2 RELAY COIL AND CLOSES TO 1-9 SCORE RELAY.
#1 RELAY	23C	Y-O BR-W	C-8	N.O.	IN CIRCUIT TO "R.O. SWITCHES CONTROL RELAY," THRU SCORE MOTOR DISC OR SWITCH ON 2ND BALL 'B' RELAY.
	23B	-Y- -J-	A-4	N.O.	IN SERIES WITH SWITCH 22B ON #2 RELAY.
	23A	-J- B-O	A-12	N.O.	IN CIRCUIT TO 6 PIN COIL, ON 2ND SHOT, WHEN PLAYER HAS A 2-4-6 LEAVE.
	24C	Y-BR -J-	A-4	N.C.	IN CIRCUIT TO FLASH MOTOR AND FLASH MOTOR RELEASE COIL.
	24B	-J- -G- G-Y-W	B-11	M&B	ENERGIZES 1 PIN COIL---ALSO IN CIRCUIT TO STRIKE ZONE SWITCHES.

RELAY	SW.	WIRE COLORS	DIAG. LOC.	TYPE	SWITCH OPERATION
# 1 RELAY	24A	-J- -J-	A-12	N.O.	IN CIRCUIT TO 4 PIN COIL, ON SECOND SHOT, WHEN PLAYER HAS A 3-4-6 LEAVE.
1ST BALL RELAY	25B	GRAY-G -Y-	E-7	N.C.	IN CIRCUIT TO "BOWL AGAIN" LITE, THRU SWITCH ON ROTO UNIT.
	25A	GRAY-Y O-B	C-11	N.O.	RUNS SCORE MOTOR TO 1ST POSITION.
	26C	GRAY-BR -Y-	D-8	N.O.	IN HOLD CIRCUIT TO ROLLOVER SWITCHES CONTROL RELAY.
	26B	-J- -Y-	A-4	N.C.	IN SERIES WITH SWITCH 24C ON #1 RELAY.
	26A	G-O -J-	A-3	N.C.	SAFETY SWITCH TO THIS RELAY COIL.
2ND BALL "A" RELAY	27B	R-BR O-W	A-6	N.C.	IN CIRCUIT TO 100'S SCORE RELAY, THRU 'P1' RIVET ON SCORE MOTOR.
	27A	BLU-BR R-Y	A-5	N.C.	IN CIRCUIT TO 10-90 SCORE RELAY, THRU (3) 'A1' RIVETS ON SCORE MOTOR. (IN "ROTO" OR "STRIKE 90").
	28C	-BR- G-Y-W	B-11	N.C.	OPENS CIRCUIT TO ALL ROLLOVER SWITCHES.
	28B	BLU-W Y-BR	A-4	N.C.	IN CIRCUIT TO FLASH MOTOR, THRU SWITCH ON ROTO UNIT.
	28A	-J- -Y- Y-R	A-3 & D-13	M&B	OPENS IN CIRCUIT TO THIS RELAY COIL AND CLOSSES TO 2ND BALL 'B' RELAY.
2ND BALL "B" RELAY	29B	O-B -Y-	D-11	N.O.	RUNS SCORE MOTOR, THRU SWITCH 25A ON 1st BALL RELAY.
	29A	O-G G-Y	D-12	N.O.	IN CIRCUIT TO EXTRA SHOTS RESET RELAY IN 10TH FRAME
	30C	Y-G BR-Y	B-8	N.O.	TO STRIKE-SPARE RESET RELAY, THRU 'P' RIVET ON SCORE MOTOR.
	30B	BR-W -Y-	D-8	N.O.	TRIPS ROLLOVER SWITCHES CONTROL RELAY, THRU SWITCH ON #1 RELAY.
	30A	W-BR -J-	C-13	N.C.	SAFETY SWITCH TO THIS RELAY COIL.

RELAY	SW.	WIRE COLORS	DIAG. LOC.	TYPE	SWITCH OPERATIONS
START RELAY	31D	G-Y-W B-W	C-13	N.C.	OPENS CIRCUIT TO COIN RELAY AND COIN LOCKOUT COIL.
	31C	GRAY-0 Y-B	B-4	N.O.	IN CIRCUIT TO ROTO UNIT S.U. COIL.
	31B	G-0 -Y-	D-9	N.O.	ENERGIZES RESET COILS ON FRAME CONTROL & COIN UNITS AND GAME-OVER RELAY, THRU 2ND POS. CAM SW. ON SCORE MTR.
	31A	BLU-Y-W B-W BR-W	B-3	M&B	OPENS IN SERIES CIRCUIT WITH SWITCH C ON GAME-OVER RELAY AND CLOSSES TO PULSE 'A', 'B' AND 'C' RESET RELAYS.
	32D	BR-R BLU-W	D-5	N.C.	PREVENTS FEEDBACK TO 1000 DRUM S.U. DURING RESET CYCLE.
	32C	0-R BR-Y	B-8	N.O.	PULSES STRIKE-SPARE RESET RELAY, THRU (5) 'TI' RIVETS ON SCORE MOTOR.
	32B	GRAY-B -Y-	D-11	N.O.	RUNS SCORE MOTOR.
	32A	G-R -0- -Y-	C-13	M&B	TO PLAYER UP UNIT RESET COIL

A.C. RELAYS & SWITCHES

LOCATED ON BACKDOOR

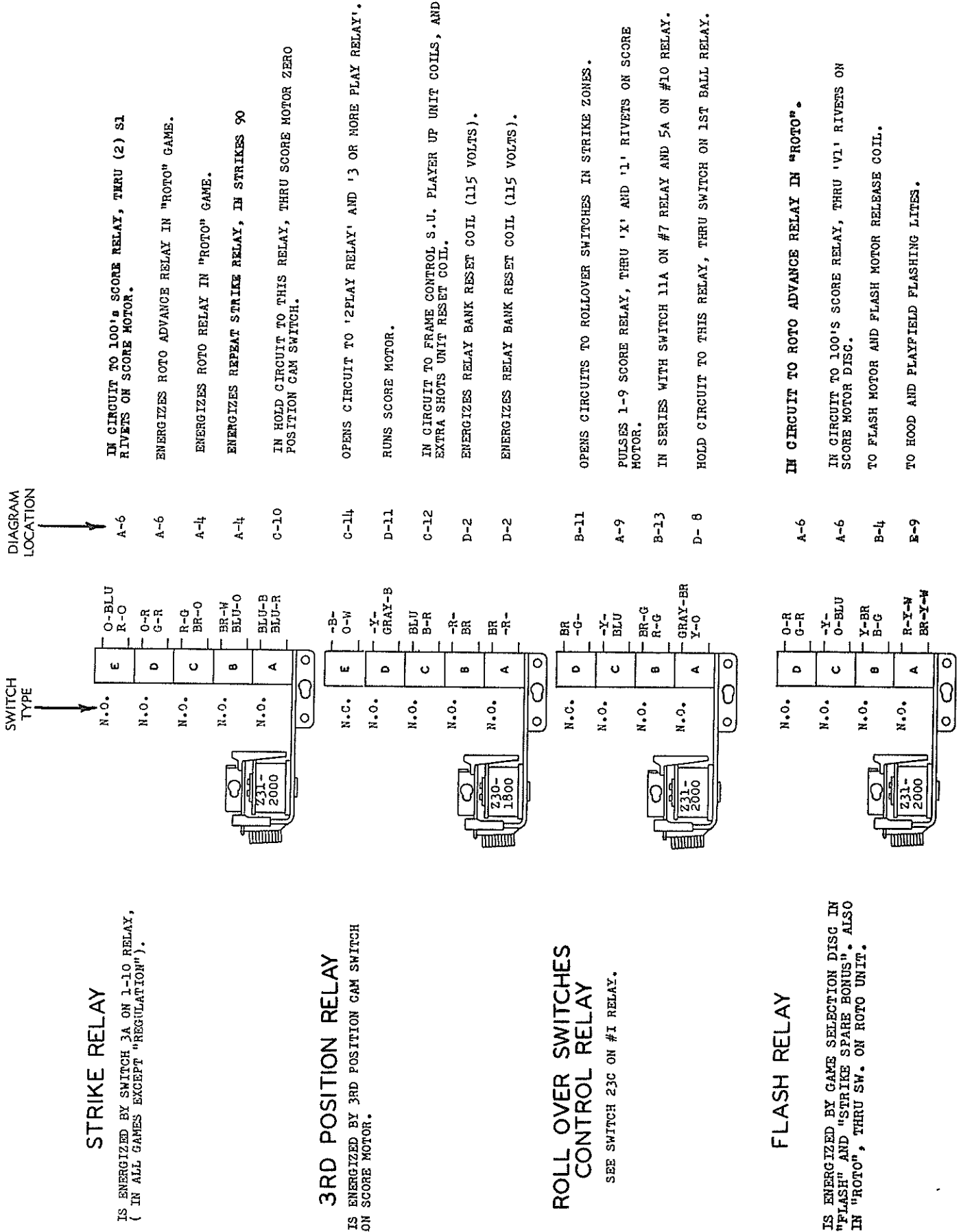

STRIKE RELAY

IS ENERGIZED BY SWITCH 3A ON 1-10 RELAY, (IN ALL GAMES EXCEPT "REGULATION").

3RD POSITION RELAY

IS ENERGIZED BY 3RD POSITION CAM SWITCH ON SCORE MOTOR.

ROLL OVER SWITCHES CONTROL RELAY

SEE SWITCH 23C ON #1 RELAY.

FLASH RELAY

IS ENERGIZED BY GAME SELECTION DISC IN "FLASH" AND "STRIKE SPARE BONUS". ALSO IN "ROTO", THRU SW. ON ROTO UNIT.

REAR ROLL OVER RELAY

IS ENERGIZED BY ANY OF THE (9) NINE REAR ROLLOVER SWITCHES.

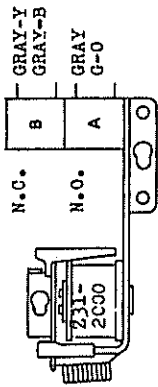

C-11 OPENS CIRCUIT TO SCORE MOTOR.

B-3 TRIPS 1ST BALL RELAY AND 2ND BALL 'A' RELAY.

GAME OVER RELAY

INTERLOCK

TRIP COIL IS ENERGIZED BY SWITCH B ON LOCK RELAY, OR BY WIPER FINGER ON FRAME CONTROL DISC.

LATCH COIL IS ENERGIZED BY START RELAY.

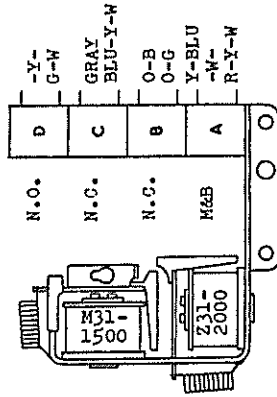

D-8 TRIPS START RELAY, THRU SWITCH ON COIN RELAY.

3-B OPENS CIRCUITS TO ALL SCORING RELAYS AND ROLLOVER SWITCHES.

B-5 SAFETY SWITCH TO TRIP COIL ON THIS RELAY.

E-5 OPENS IN CIRCUIT TO MOST OF THE LITES AND CLOSE TO GAME-OVER LITE.

ROTO ADVANCE RELAY

IS ENERGIZED, IN "ROTO", BY FLASH RELAY OR STRIKE RELAY, THRU 'R' AND 'R1' RIVETS ON SCORE MOTOR.

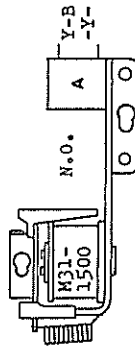

A-4 ENERGIZES ROTO UNIT S.U. COIL.

ROTO RELAY

IS ENERGIZED, IN "ROTO", BY THE STRIKE RELAY, THRU A SWITCH ON THE ROTO UNIT.

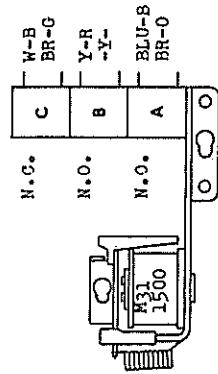

D-12 IN SERIES WITH SWITCH C ON REPEAT STRIKE RELAY.

E-7 TO "BOWL AGAIN" LITE.

B-4 HOLD CIRCUIT TO THIS RELAY, THRU ZERO POSITION CAM SWITCH ON SCORE MOTOR.

STRIKE SPARE ADVANCE RELAY

IS PULSED ONCE FOR A SPARE AND TWICE FOR A STRIKE BY THE 'F' RIVETS ON SCORE MOTOR DISC.

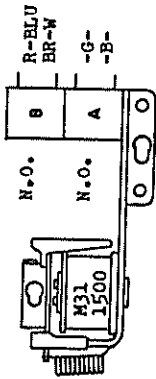

C-9

ENERGIZES EXTRA SHOTS UNIT S.U. COIL IN 10TH FRAME.

C-7

ENERGIZES (6) STRIKE-SPARE UNIT S.U. COILS, THRU PLAYER UP DISC.

STRIKE SPARE RESET RELAY

IS PULSED, DURING RESET CYCLE, BY (5) 'M' RIVETS ON SCORE MOTOR DISC. THIS RELAY IS CONTROLLED BY THE POSITION OF THE PLAYERS STRIKE-SPARE UNIT THRU THE 'K', 'L' AND 'P' RIVETS ON SCORE MOTOR DISC.

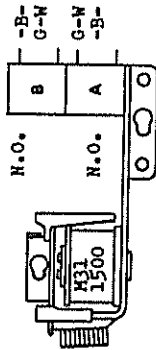

C-6

THESE SWITCHES, IN PARALLEL, ENERGIZE THE STRIKE-SPARE UNIT RESET COILS THRU THE CORRESPONDING STRIKE-SPARE UNIT ZERO SWITCHES.

C-7

I-9 SCORE RELAY

OPERATES WHEN LESS THAN 10 PINS ARE MADE ON TWO SHOTS. IT ALSO OPERATES AFTER THE FIRST SHOT, WHEN PLAYER IS HOLDING A SPARE OR TWO STRIKES AND GETS LESS THAN 10 PINS.

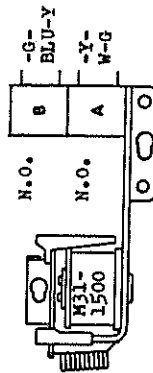

B-5

PULSES 10-90 SCORE RELAY, THRU 9TH POSITION SWITCHES ON 1-9 DRUM UNITS.

D-3

PULSES 1-9 DRUM UNITS, THRU PLAYER UP DISC.

10-90 SCORE RELAY

OPERATES, IN "ROTO" OR "STRIKE-90", THRU 'A1' AND 'B1' RIVETS ON SCORE MOTOR. IT ALSO OPERATES, IN "STRIKE SPARE BONUS" AND "REGULATION", THRU 'G' OR 'J' RIVETS ON SCORE MOTOR.

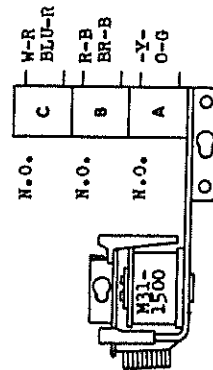

A-6

PULSES 100'S SCORE RELAY, THRU 9TH POSITION SWITCHES ON 10-90 DRUM UNITS.

C-10

ENERGIZES CHIME COIL.

D-4

PULSES 10-90 DRUM UNITS, THRU PLAYER UP DISC.

100'S SCORE RELAY

OPERATES IN "ROTO" AND "FLASH", THRU 'V1' RIVETS ON SCORE MOTOR. ALSO IN "STRIKE SPARE BONUS", THRU 'V2' RIVETS ON SCORE MOTOR.

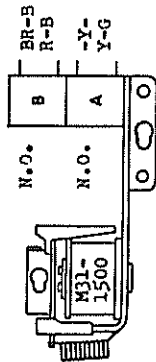

C-10

D-5

ENERGIZES BELL COIL.

PULSES 100'S DRUM UNITS---ALSO 1000'S DRUM UNITS THRU 9TH POSITION SWITCHES ON 100'S DRUM UNITS.

SCORE MOTOR RELAY

IS ENERGIZED BY THE SAME CIRCUITS THAT RUN THE SCORE MOTOR.

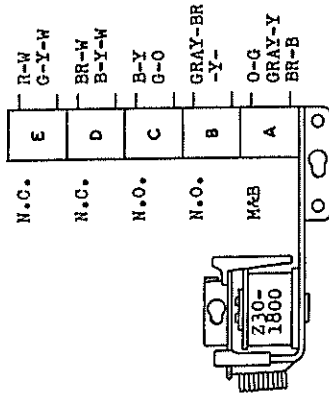

C-13

B-10

A-3

D-11

C-11

OPENS CIRCUIT TO COIN RELAY AND COIN LOCKOUT COIL.

PREVENTS #2 TO #10 RELAYS FROM TRIPPING WHILE SCORE MOTOR CYCLES.

TRIPS 2ND BALL 'A' RELAY, THRU SWITCH ON REAR ROLLOVER RELAY.

RUNS SCORE MOTOR THRU SWITCH 1C ON 1-10 RELAY.

OPENS IN CIRCUIT TO ROLLOVER MOTOR RELAY AND CLOSES IN HOLD CIRCUIT TO SCORE MOTOR RELAY.

SCORE CONTROL RELAY

IS ENERGIZED BY THE 'H' RIVETS ON SCORE MOTOR, WHEN A PLAYER IS HOLDING A SPARE OR TWO STRIKES AND GETS LESS THAN 10 PINS ON THE FIRST SHOT. ALSO WHEN A STRIKE IS FOLLOWED BY A BLOW.

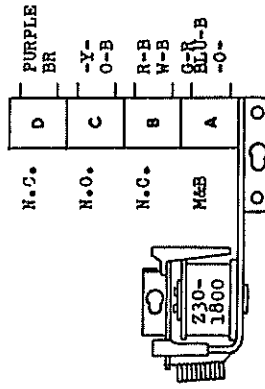

D-2

D-11

D-12

A-9

OPENS CIRCUIT TO RELAY BANK RESET COIL (115 VOLTS).

RUNS SCORE MOTOR, THRU SWITCH ON 1ST BALL RELAY.

IN SERIES WITH SWITCH C ON ROTO RELAY.

OPENS IN CIRCUIT TO PIN RESET RELAY AND CLOSES IN HOLD CIRCUIT TO SCORE CONTROL RELAY.

EXTRA SHOTS RESET RELAY

IS ENERGIZED BY 'Q' & 'V' RIVETS ON SCORE MOTOR DISC, THRU CIRCUITS ORIGINATING IN THE EXTRA SHOTS UNIT DISC.

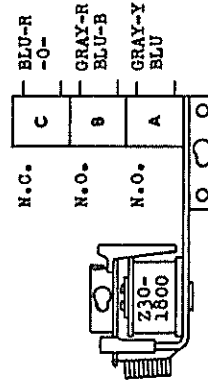

B-9

A-9

C-12

OPENS CIRCUIT TO SCORE CONTROL RELAY.

ENERGIZES PIN RESET RELAY, THRU ZERO POSITION CAM SWITCH ON SCORE MOTOR.

IN HOLD CIRCUIT TO THIS RELAY.

REPEAT STRIKE RELAY

IS ENERGIZED BY A SWITCH ON STRIKE RELAY, IN "STRIKES 90"

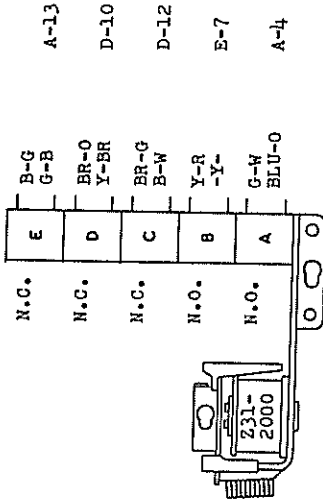

OPENS "EASY STRIKE" CIRCUIT.
 OPENS CIRCUIT TO GAME SELECTION UNIT S.U. COIL.
 IN CIRCUIT TO EXTRA SHOTS RESET RELAY.
 TO "BOWL AGAIN" LITE.
 HOLD CIRCUIT TO THIS RELAY, THRU 1ST POSITION CAM SWITCH ON SCORE MOTOR.

ROLL OVER MOTOR RELAY

IS ENERGIZED, ON FIRST SHOT, BY THE SAME CIRCUIT THAT RUNS THE SCORE MOTOR. IT IS THEN HELD IN THRU 1ST POSITION CAM SWITCH ON SCORE MOTOR.

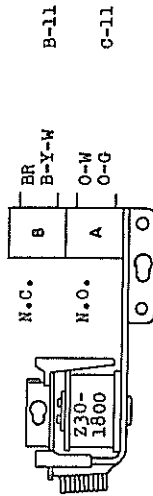

OPENS CIRCUITS TO ROLLOVER SWITCHES AS PUCK RETURNS TO PLAYER.
 HOLD CIRCUIT TO THIS RELAY, THRU 1ST POSITION CAM SWITCH ON SCORE MOTOR.

PLAYER RESET RELAY

IS ENERGIZED BY THE 'N' AND 'PH' RIVETS ON SCORE MOTOR, THRU THE COIN DISC AND PLAYER UP DISC.

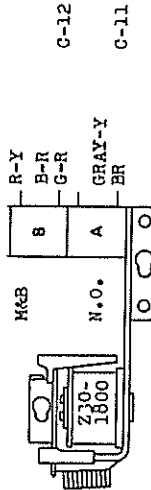

IN CIRCUIT TO PLAYER UP UNIT COILS AND FRAME CONTROL UNIT S.U. COIL.
 IN HOLD CIRCUIT TO THIS RELAY.

COIN RELAY

IS PULSED BY COIN SWITCH. IN 'MULTIPLE PLAY', THE COIN RELAY IS ENERGIZED BY THE CREDIT BUTTON, THRU THE ZERO SWITCH ON CREDIT UNIT.

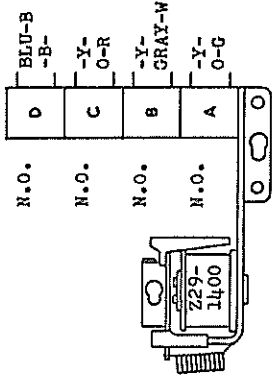

C-8 TRIP START RELAY AND PULSES COIN METER.

D-13 IN HOLD CIRCUIT TO THIS RELAY, THRU COIN UNIT E.O.S. SWITCH.

D-14 PULSES CREDIT BUTTON RELAY (IN MULTIPLE PLAY CIRCUIT).

D-15 ENERGIZES COIN UNIT S.U. COIL. ALSO ENERGIZES CREDIT UNIT RESET COIL (IN MULTIPLE PLAY CIRCUIT).

LOCK RELAY

IS ENERGIZED BY SWITCH ON 'A' RESET RELAY.

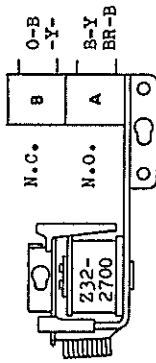

A-5 TRIPS GAME-OVER RELAY.

D-8 HOLD CIRCUIT TO THIS RELAY, THRU BACK-BOX FILT SWITCH.

PIN RESET RELAY

IS ENERGIZED BY SWITCH B ON EXTRA SHOTS RESET RELAY. IT IS ALSO ENERGIZED BY 'S' AND 'Z' RIVETS ON SCORE MOTOR, THRU SWITCH A ON SCORE CONTROL RELAY.

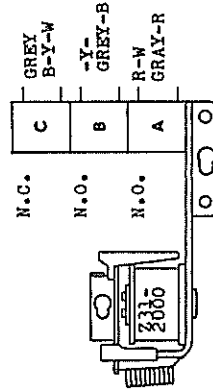

B-9 OPENS CIRCUITS TO PLAYFIELD ROLLOVER SWITCHES.

D-9 RUNS PIN RESET MOTOR.

A-9 IN HOLD CIRCUIT TO THIS RELAY, THRU 1ST POSITION CAM SWITCH ON PIN RESET MOTOR.

LOCATED ON PIN — PANEL

2 COIN "B" RELAY

IS ENERGIZED BY NICKEL COIN SWITCH (BROWN-BLACK).

LOCATED ON MULTIPLE PLAY ASSEMBLY

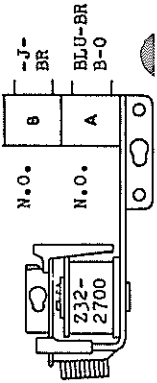

C-15 PULSES CREDIT S.U. COIL, THRU SWITCH B ON 2 COIN 'A' RELAY.

D-14 HOLD CIRCUIT TO THIS RELAY, THRU CREDIT UNIT E.O.S. SWITCH.

2 COIN "A" RELAY

IS ENERGIZED BY DIME COIN SWITCH (BLU-WHITE).

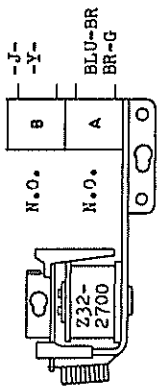

D-15 IN SERIES WITH SWITCH B ON 2 COIN 'B' RELAY.

D-14 HOLD CIRCUIT TO THIS RELAY, THRU CREDIT UNIT E.O.S. SWITCH.

CREDIT BUTTON RELAY

IS ENERGIZED BY THE COIN RELAY.

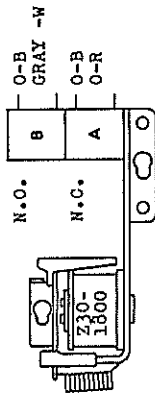

D-14 IN HOLD CIRCUIT TO THIS RELAY.

D-13 IN CIRCUIT TO COIN RELAY, THRU CREDIT PUSH BUTTON SWITCH.

3 OR MORE PLAY RELAY

IS ENERGIZED BY 3 OR MORE PLAY DROP CHUTE SWITCH.

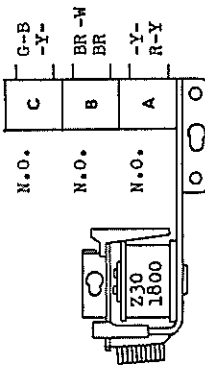

D-14 ENERGIZES "2 PLAY RELAY".

C-15 PULSES CREDIT UNIT S.U. COIL, THRU SCORE MOTOR DISC.

C-15 IN HOLD CIRCUIT TO THIS RELAY.

2 PLAY RELAY

IS ENERGIZED BY 2 PLAY DROP CHUTE SWITCH.

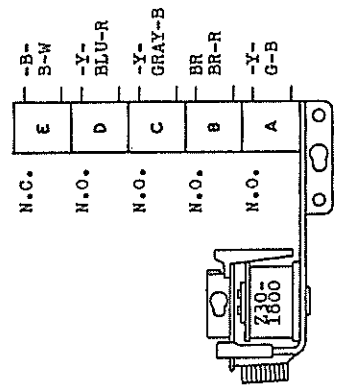

C-13 OPENS CIRCUITS TO FRAME, PLAYER AND EXTRA SHOTS UNITS.

A-8 ENERGIZES SCORE CONTROL RELAY.

D-11 RUNS SCORE MOTOR.

D-15 PULSES CREDIT UNIT S.U. COIL, THRU SCORE MOTOR DISC.

D-14 IN HOLD CIRCUIT TO THIS RELAY.

A. C. RELAYS & SWITCHES

"A" RESET RELAY

THIS RELAY IS PULSED BY (11) 'W' RIVETS ON SCORE MOTOR DISC. WHEN SWITCH ON START RELAY IS CLOSED.
(DURING RESET CYCLE)

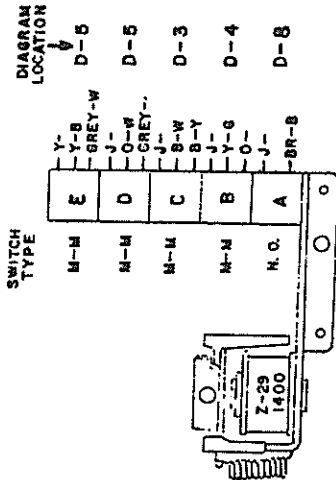

OPERATION

PULSES 1ST & 2ND PLAYER 100-900 DRUM UNITS.
PULSES 1ST & 2ND PLAYER 1,000 DRUM UNITS.
PULSES 1ST & 2ND PLAYER 1-9 DRUM UNITS.
PULSES 1ST & 2ND PLAYER 10-90 DRUM UNITS.
ENERGIZES LOCK RELAY.

"B" RESET RELAY

THIS RELAY IS PULSED BY (11) 'W' RIVETS ON SCORE MOTOR DISC. THRU SW. ON START RELAY.
(DURING RESET CYCLE)

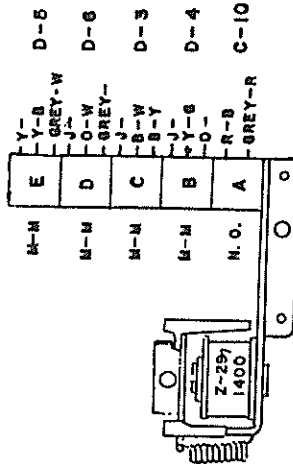

PULSES 3RD & 5TH PLAYER 100-900 DRUM UNITS.
PULSES 3RD & 5TH PLAYER 1,000 DRUM UNITS.
PULSES 3RD & 5TH PLAYER 1-9 DRUM UNITS.
PULSES 3RD & 5TH PLAYER 10-90 DRUM UNITS.
ENERGIZES GAME SELECTION S.U. COIL THRU GAME SELECTION DISC.

"C" RESET RELAY

THIS RELAY IS PULSED BY (11) 'W' RIVETS ON SCORE MOTOR DISC., THRU SW. ON START RELAY.
(DURING RESET CYCLE)

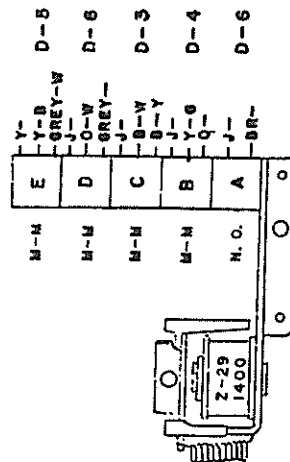

PULSES 4TH & 6TH PLAYER 100-900 DRUM UNITS.
PULSES 4TH & 6TH PLAYER 1,000 DRUM UNITS.
PULSES 4TH & 6TH PLAYER 1-9 DRUM UNITS.
PULSES 4TH & 6TH PLAYER 10-90 DRUM UNITS.
PULSES FRAME DRUM S.V.

NOTES